

PEDRALI

SEATING 03

2020

CHAIRS
MODULAR SEATINGS
LOUNGE CHAIRS
BARSTOOLS
TABLES
TABLE BASES
TABLE TOPS
LIGHTING
COMPLEMENTS

SEATING 03

SEATING03_2003

2020

PEDRALI[®]

Pedrali SpA

Sp 122 Mornico Al Serio

24050 Bergamo - Italy

Export Dept. Tel: +39 035 8358840

Ufficio Commerciale Italia Tel: +39 035 8358810

info@pedrali.it

www.pedrali.it

Families index

Indice delle famiglie

SEATING

PRODUCT NAME NOME PRODOTTO	CATALOGUE CATALOGO
-------------------------------	-----------------------

Allure	Seating 01
Ara	Seating 03
Arki-Stool	Seating 02
Arod	Seating 02
Babila	Seating 01
Blitz	Seating 01
Box	Seating 03
Brera	Seating 02
Buddy	Seating 04
Cube	Seating 03
Day Dream	Seating 02
Dome	Seating 01
Dream	Seating 03
Dress	Seating 04
Elinor	Seating 03
Elle	Seating 04
Enjoy	Seating 03
Ester	Seating 04
Feel	Seating 02
Folk	Seating 02
Fox	Seating 04
Frida	Seating 01
Glam	Seating 02
Gliss	Seating 02
Gossip	Seating 02
Grace	Seating 02
Happy	Seating 03
Héra	Seating 04

PRODUCT NAME
NOME PRODOTTO

CATALOGUE
CATALOGO

Host Seating 04
Hx Seating 03
Ice Seating 03
Ikon bench Seating 03
Inga Seating 02
Intrigo Seating 03
Island Seating 04
Jamaica Seating 02
Jazz Seating 01
Jil Seating 03
Joi Seating 01
Joker Seating 04
Koi-Booki Seating 01
Kuadra Seating 03
Kuadra XL Seating 03
Laja Seating 01
Leila Seating 04
Log Seating 04
Lotus Seating 03
Malmö Seating 02
Mies Seating 04
Modus Seating 04
Mood Seating 04
Mya Seating 03
Nemea Seating 02
Noa Seating 01
Nolita Seating 02
Nym Seating 02

PRODUCT NAME
NOME PRODOTTO

CATALOGUE
CATALOGO

Osaka Seating 02
Pasha Seating 04
Plural Seating 03
Plus Seating 01
Queen Seating 04
Remind Seating 04
Reva Seating 04
Rubik Seating 01
Serif Seating 01
Sign Seating 04
Snow Seating 01
Social Seating 04
Soul Seating 04
Sunset Seating 01
Tatami Seating 03
Temps Seating 03
Tivoli Seating 02
Tonda Seating 03
Tribeca Seating 04
Tweet Seating 01
Twig Seating 02
Tx Seating 01
Vic Seating 04
Volt Seating 03
Woody Seating 01
Wow Seating 04
Young Seating 02
Zippo Seating 04
Zx Seating 03

Legend

Legenda

SEATING

- Pasha
- Plural
- Plus
- Queen
- Remind
- Reva
- Rubik
- Serif
- Sign
- Snow
- Social
- Soul
- Sunset
- Tatami
- Temps
- Tivoli
- Tonda
- Tribeca
- Tweet
- Twig
- Tx
- Vic
- Volt
- Woody
- Wow
- Young
- Zippo
- Zx

	SIDE CHAIR	ARMCHAIR	BARSTOOL	LOW STOOL	LOUNGE SEATING	MODULAR SEATING	EXECUTIVE CHAIR	METAL	PLASTIC MATERIAL	UPHOLSTERED	WOOD	OUTDOOR VERSION
Pasha	●	●	●	●	●	●	●	●	●	●	●	●
Plural	●	●	●	●	●	●	●	●	●	●	●	●
Plus	●	●	●	●	●	●	●	●	●	●	●	●
Queen	●	●	●	●	●	●	●	●	●	●	●	●
Remind	●	●	●	●	●	●	●	●	●	●	●	●
Reva	●	●	●	●	●	●	●	●	●	●	●	●
Rubik	●	●	●	●	●	●	●	●	●	●	●	●
Serif	●	●	●	●	●	●	●	●	●	●	●	●
Sign	●	●	●	●	●	●	●	●	●	●	●	●
Snow	●	●	●	●	●	●	●	●	●	●	●	●
Social	●	●	●	●	●	●	●	●	●	●	●	●
Soul	●	●	●	●	●	●	●	●	●	●	●	●
Sunset	●	●	●	●	●	●	●	●	●	●	●	●
Tatami	●	●	●	●	●	●	●	●	●	●	●	●
Temps	●	●	●	●	●	●	●	●	●	●	●	●
Tivoli	●	●	●	●	●	●	●	●	●	●	●	●
Tonda	●	●	●	●	●	●	●	●	●	●	●	●
Tribeca	●	●	●	●	●	●	●	●	●	●	●	●
Tweet	●	●	●	●	●	●	●	●	●	●	●	●
Twig	●	●	●	●	●	●	●	●	●	●	●	●
Tx	●	●	●	●	●	●	●	●	●	●	●	●
Vic	●	●	●	●	●	●	●	●	●	●	●	●
Volt	●	●	●	●	●	●	●	●	●	●	●	●
Woody	●	●	●	●	●	●	●	●	●	●	●	●
Wow	●	●	●	●	●	●	●	●	●	●	●	●
Young	●	●	●	●	●	●	●	●	●	●	●	●
Zippo	●	●	●	●	●	●	●	●	●	●	●	●
Zx	●	●	●	●	●	●	●	●	●	●	●	●

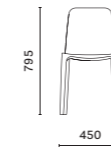

All dimensions are expressed in millimeters
Tutte le dimensioni sono espresse in millimetri



Stackable product
Prodotto impilabile



Product suitable for outdoor use
Prodotto adatto per utilizzo in esterni



Product not recommended for outdoor use
Prodotto non adatto per utilizzo in esterni



Product with fire-retardant finish
Prodotto con finitura ignifuga



Product with swivel seat
Prodotto con seduta girevole



Swivel seat with spring back device
Prodotto con seduta girevole e meccanismo di ritorno automatico



FSC™ certified product
Prodotto certificato FSC™



GREENGUARD certified product
Prodotto certificato GREENGUARD



CATAS certified product
Prodotto certificato CATAS

Seating 03 index

Indice delle sedute 03

PRODUCT NAME NOME PRODOTTO	PAGE PAGINA
Ara	034
Box	216
Cube	238
Dream	262
Elinor	072
Enjoy	128
Happy	148
Hx	252
Ice	114
Ikon bench	064
Intrigo	086
Jil	226
Kuadra	182
Kuadra XL	154
Lotus	258
Mya	098
Plural	048
Tatami	136
Temps	080
Tonda	270
Volt	012
Zx	266

Volt

Injection of dynamism

DESIGN
Claudio Dondoli - Marco Pocci, 2013

EN — The thin sections, along with ergonomic shape and lovely proportions make Volt a collection of polypropylene chairs that stands out for attention to details. Volt is elegant, cozy, equally lightweight and handy, featured by thin edges and chamfered profiles. All the models in the collection are also available with padded seat version.

IT — Il tratto sottile, la forma ergonomica e le gradevoli proporzioni rendono Volt una collezione di sedute in polipropilene che si distingue per la cura dei dettagli. Leggera e facile da maneggiare, caratterizzata da spessori esili e profili smussati, Volt è elegante e accogliente. Tutti i modelli della collezione sono disponibili anche con sedile imbottito.



Side chair sedia Volt
Armchair poltrona Volt
Table tavolo Ypsilon



Side chair

Sedia



Armchair

Poltrona



Barstool

Sgabello

Seat height
Altezza seduta
660 mm



Upholstered
seat version
Versione con
seduta imbottita



Seat height
Altezza seduta
765 mm





Skyway Montebianco

Courmayeur, Italy

Project: Café & Restaurant

Products: Volt side chair
and armchair, Malmö side chair
and armchair





Apartment for a Guy and Even two of them

Poznan, Poland

Project: Private house

Architect: Metaforma

Product: Volt side chair



Microsoft House

Milan, Italy

Project: Office

Architects: Herzog & de Meuron (building architecture), DEGW - brand of Lombardini22 (Interior Design & Space Planning)

Products: Volt side chair, Malmö side chair, Modus modular seating, Arki-Base table, Happy Apple lighting

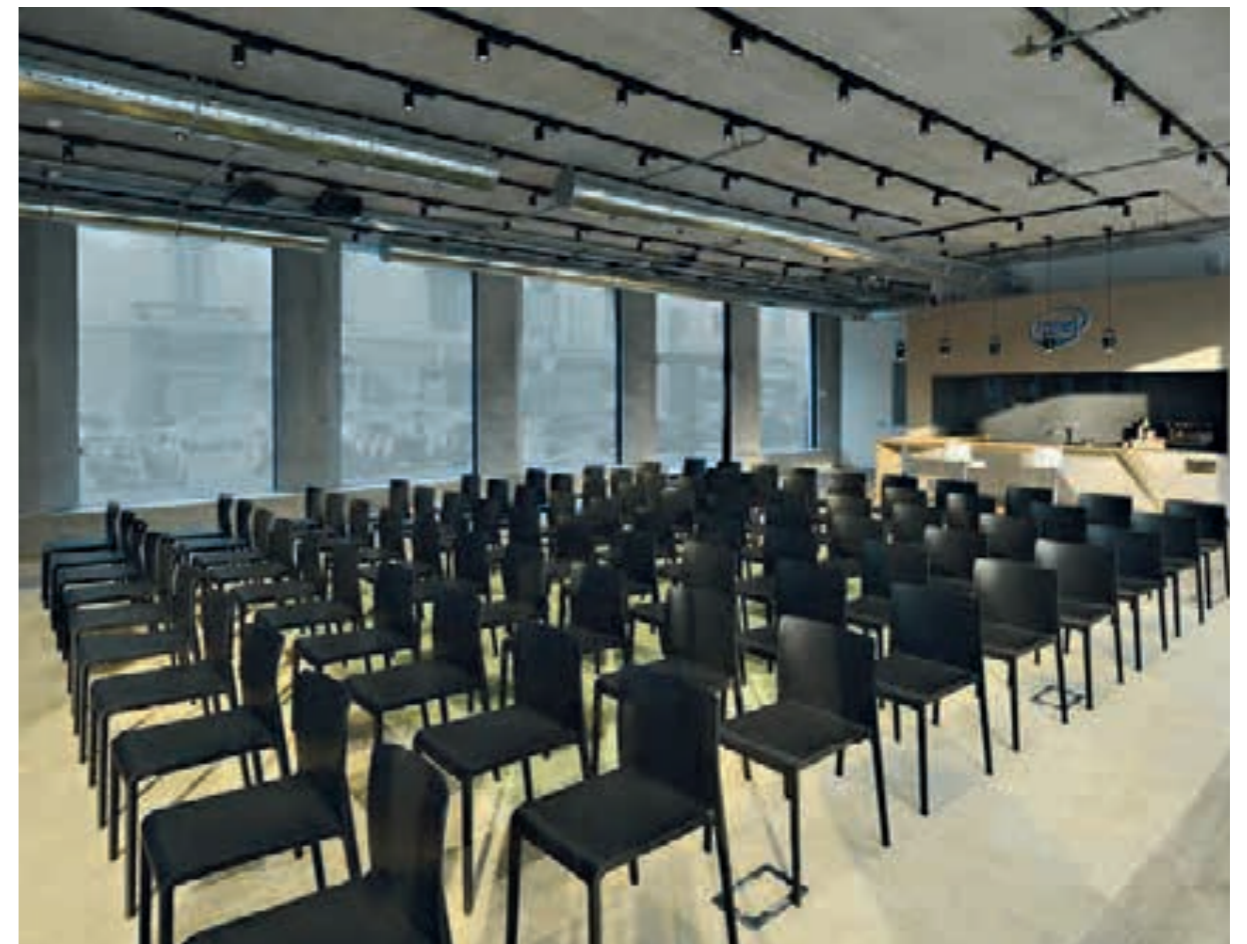

Labirinto della Masone di Franco Maria Ricci

Fontanellato - Parma, Italy

Project: Cultural Park

Products: Volt side chair, Ypsilon table,
Tivoli side chair and armchair,
Modus modular seating



Sebbah House

Begur, Spain

Project: Private house

Architects: Pepe Gascón Arquitectura,
Asa Alexandre Boulin

Products: Volt armchair, Arki-Table,
Malmö Relax lounge armchair,
Babila side chair





GPS Plaza

Astorga - León, Spain

Project: Café & Restaurant

Architect: Andrea Muñoz Diseño

Products: Volt barstool,
Brik umbrella stand

SIZES / DIMENSIONI

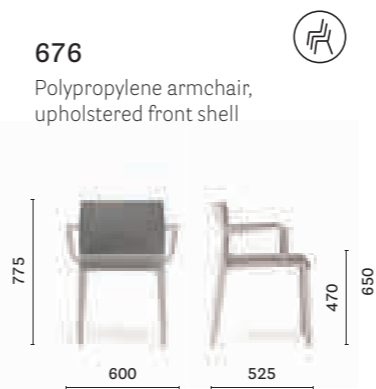
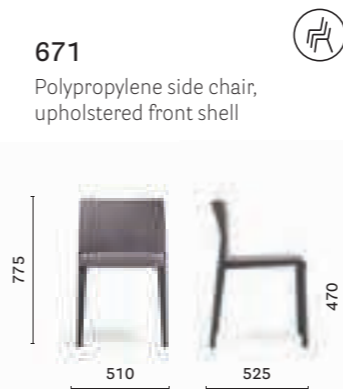

SIZES / DIMENSIONI

677

Polypropylene barstool



677/2

Polypropylene barstool,
upholstered seat



678

Polypropylene barstool

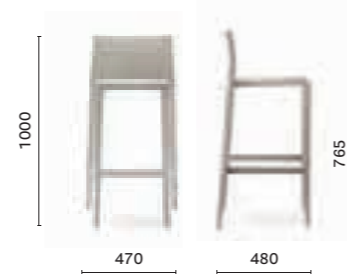

678/2

Polypropylene barstool,
upholstered seat



FINISHES / FINITURE

polypropylene / polipropilene

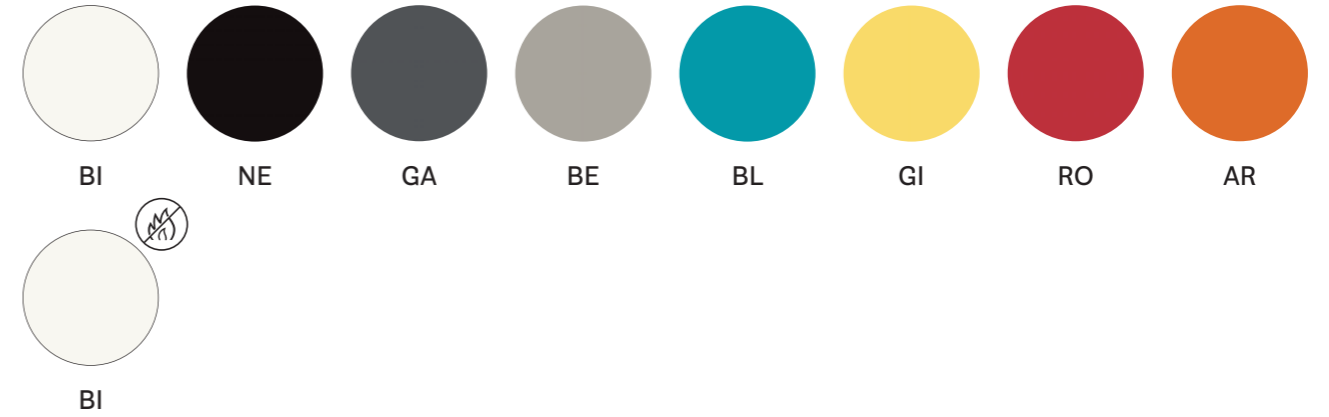

fabrics / tessuti

→ see booklet for finishes
vedi catalogo finiture



AWARDS / PREMI



reddot award 2014
winner

CERTIFICATES / CERTIFICAZIONI



According to EN 16139:2013 level 2, extreme
EN di riferimento 16139:2013 livello 2, estremo



For
670-673-674-675-677-678

Ara

Timeless seduction

DESIGN
Jorge Pensi Design Studio, 2011

EN — Ara collection made in polypropylene with its aesthetic language, refined and well-balanced, becomes so unique thanks to the peculiarity of the handle at the end of the backrest.

IT — Il linguaggio formale, equilibrato ed elegante della collezione Ara, realizzata in polipropilene, è reso unico dalla caratteristica maniglia posta all'estremità dello schienale, capace di connotare la seduta rendendola al contempo funzionale e stilisticamente riconoscibile.



Side chair

Sedia



Armchair

Poltrona

Handle in the upper part of the back
Maniglia nella parte alta dello schienale



Seat height
Altezza seduta
420 mm



Lounge armchair

Poltrona lounge





The View Boutique Hotel

Lugano, Switzerland

Project: Hotel

Product: Ara armchair, Volt armchair





Nò-Do

Paratico, Italy

Project: Restaurant

Products: Ara side chair and armchair, Ikon table, Time Out lighting, Twig chair, Ypsilon table

Green Design

Piazza Antico Lavatoio
Bergamo, Italy

Project: Temporary installation

Products: Ara Lounge armchair, Ypsilon coffee table, Giravolta lighting, Happy Apple lighting





Temporary installation

Brescia, Italy

Project: Outdoor
Products: Ara armchair,
Ypsilon table

Al Punto 85

Madrid, Spain

Project: Restaurant
Products: Ara armchair,
Sign armchair



SIZES / DIMENSIONI

310
Polypropylene side chair

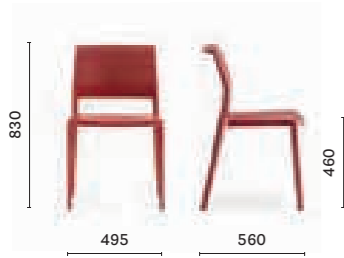

310/CL1
Polypropylene side chair,
fire-retardant grade



315
Polypropylene armchair



315/CL1
Polypropylene armchair,
fire-retardant grade



310.3
Thermoformed cushion only
WIDTH: 440



316
Polypropylene lounge armchair

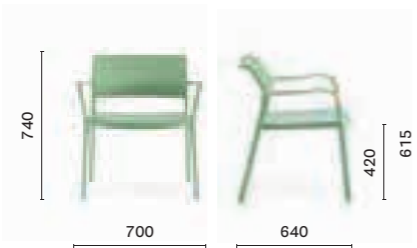

FINISHES / FINITURE

polypropylene / polipropilene (Ara side chair and armchair)

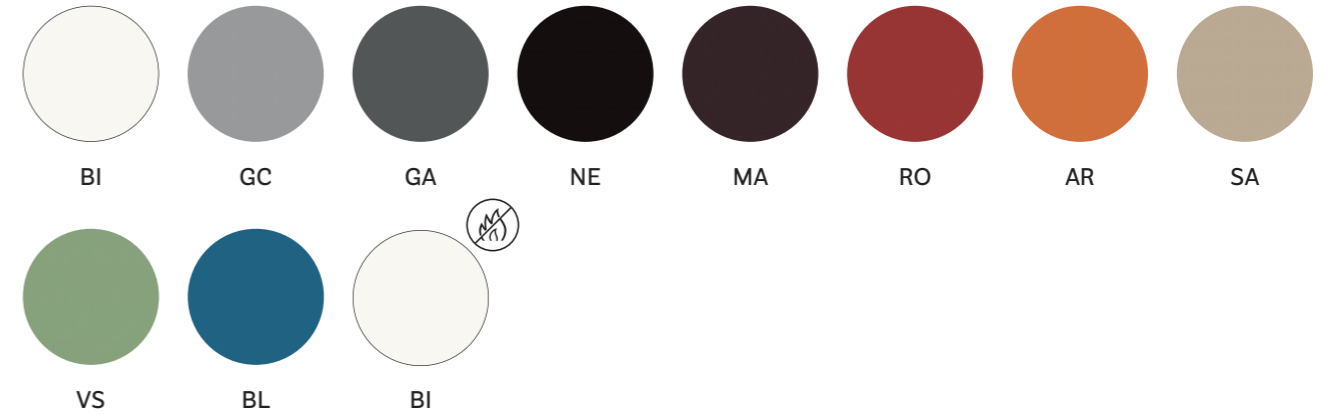

polypropylene / polipropilene (Ara lounge armchair)

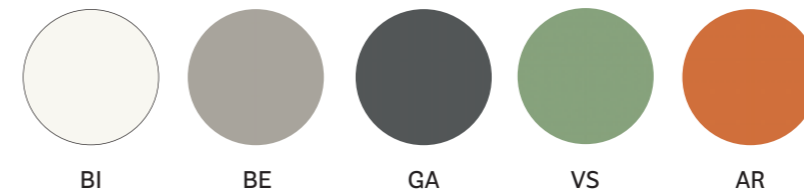

thermoformed / termoformato



AWARDS / PREMI



CERTIFICATES / CERTIFICAZIONI

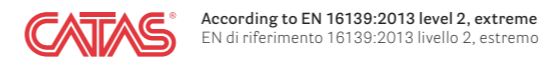

For
310 - 315 - 316

Plural

Take your time

DESIGN
Jorge Pensi Design Studio, 2014

EN — The multiple seaters Plural are conceived for work activity, for waiting and leisure. A combination of materials, such as polypropylene for the seater and the aluminium die-cast aluminium frame. Plural represents an ideal solution for waiting areas in different environments.

IT — Le sedute multiple Plural sono progettate per attività di lavoro, di attesa e di svago. Combinando materiali, quali il polipropilene della seduta e la pressofusione di alluminio del telaio, Plural rappresenta una soluzione ideale per connotare ambienti d'attesa di diversa natura.

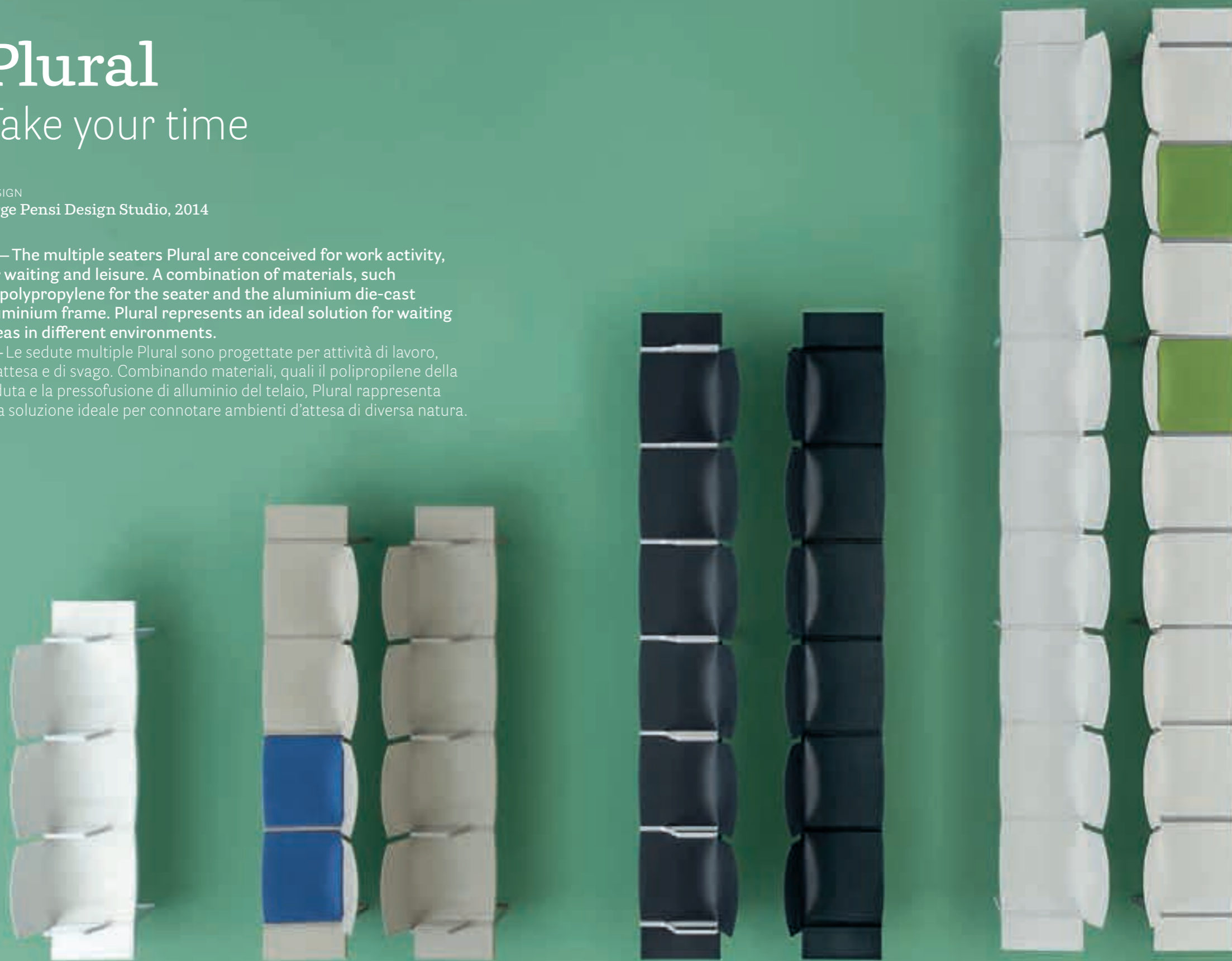

WAITING

WAITING



Modular seating seduta modulare Plural

Modular seating seduta modulare Plural



**Modular
seating**
Seduta
modulare





Area Relax & Recharge

Host 2017
Milan, Italy

Project: Temporary installation
Product: Plural modular seating,
Time Out lighting, Volt barstool,
Ikon table, Social modular seating





Light Frames

Salone Internazionale
del Mobile 2015
Milan, Italy

Project: Exhibition stand
Architect: Migliore+Servetto Architects
Product: Plural modular seating

SIZES / DIMENSIONI

P02003

Bench multiple seater, polypropylene shell, die-cast aluminium frame, 3 seats

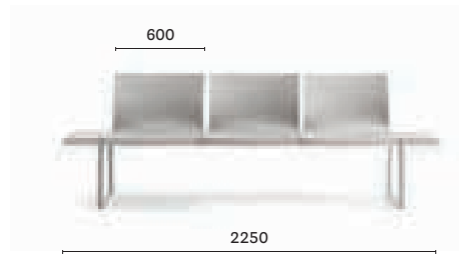

P02004

Bench multiple seater, polypropylene shell, die-cast aluminium frame, 4 seats

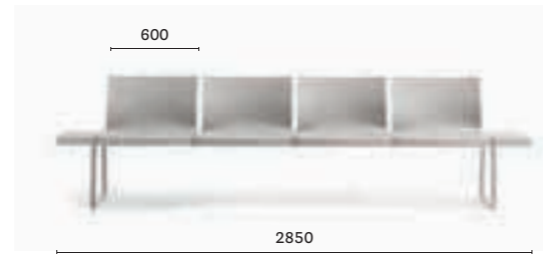

P02006

Bench multiple seater, polypropylene shell, die-cast aluminium frame, 6 seats

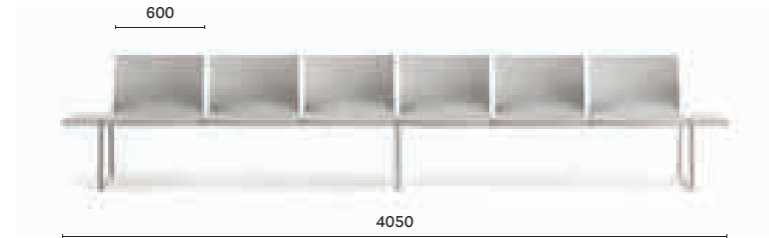

P02009

Bench multiple seater, polypropylene shell, die-cast aluminium frame, 9 seats

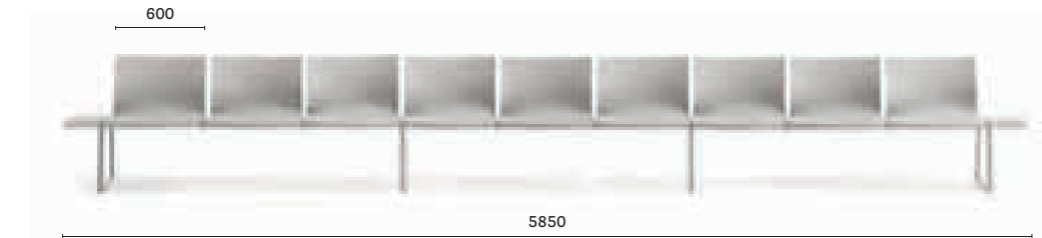

P02013, P02014, P02016, P02019

Bench multiple seater, polypropylene shell, die-cast aluminium frame with armrests, available in 3, 4, 6 and 9 seats

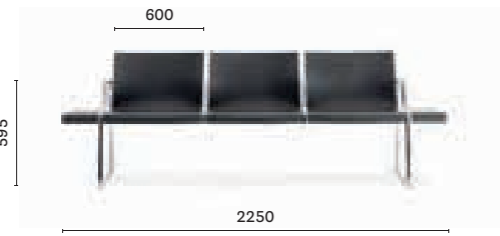
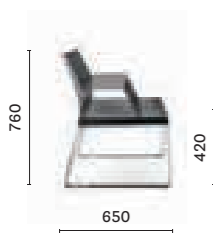

SIZES / DIMENSIONI

P02023, P02024, P02026, P02029

Bench multiple seater, polypropylene shell, die-cast aluminium frame with outside armrests, available in 3, 4, 6 and 9 seats

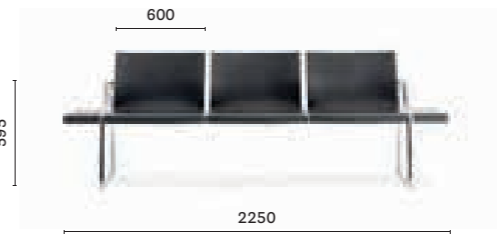

Upholstered seat

Available for every model of bench



P020_USB

USB optional kit

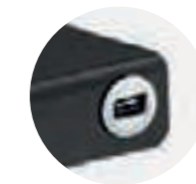

Floor fixing kit: surcharge

Kit di fissaggio a terra: supplemento

FINISHES / FINITURE

polypropylene / polipropilene

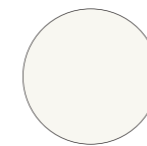

BI



BE



NE

aluminium / alluminio



CR
Chromed
Cromato

fabrics / tessuti

→ see booklet for finishes
vedi catalogo finiture

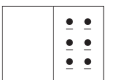

powder coated / verniciato

→ see booklet for finishes
vedi catalogo finiture

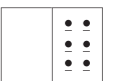

CERTIFICATES / CERTIFICAZIONI



According to EN 16139:2013 level 2, extreme
EN di riferimento 16139:2013 livello 2, estremo

Ikon bench

More than just a cone

DESIGN

Pio e Tito Toso, 2013

EN — Versatility, simple shapes and basic design, the collection of modular benches Ikon comes from the synthesis of beauty and functionality. Linear or curved, Ikon bench has conical bases in polypropylene glass fibers charged, and a seater in solid laminate. For a greater comfort, padded cushions in fabric or simil leather are available.

IT — Versatilità, forme semplici e stile minimal, la collezione di sedute modulari Ikon nasce dalla sintesi di bellezza e funzionalità. Lineare o curva, la panca Ikon presenta basi coniche in polipropilene stampato a iniezione rinforzato con fibre di vetro e una seduta in stratificato. Sono disponibili cuscini imbottiti rivestiti in tessuto o finta pelle per garantire il massimo comfort.



Modular seating seduta modulare Ikon bench





Modular seating seduta modulare Ikon bench



Solid laminate seat
Ripiano in stratificato

B863_1C

Modular seating Seduta modulare



Upholstered cushions for indoor
use, available for linear unit only
Cuscini imbottiti indoor
per moduli lineari

B863_1L + B863.4



Temporary installation

London, United Kingdom

Project: Temporary installation

Product: Ikon bench

SIZES / DIMENSIONI

B863_1L

Modular seating, solid laminate seat, polypropylene base



B863_1C

Modular seating, solid laminate seat, polypropylene base
R:1400



B863.4

Upholstered cushion only
WIDTH: 380

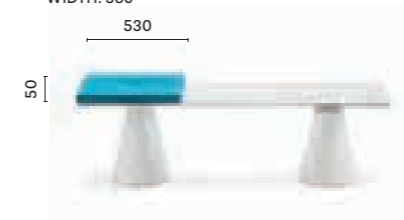

FINISHES / FINITURE

polypropylene / polipropilene



solid laminate seats / ripiani in stratificato

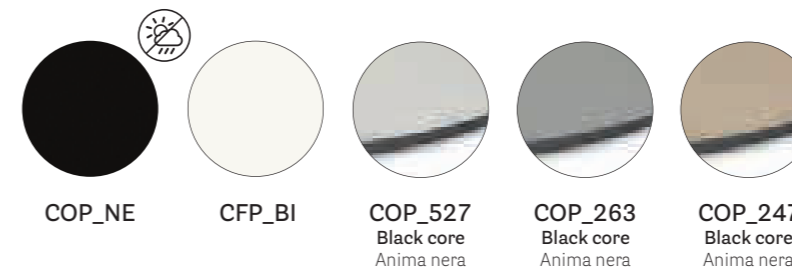

fabrics / tessuti

→ see booklet for finishes
vedi catalogo finiture



Elinor

A classy hug

DESIGN
Claudio Bellini, 2018

EN — Elinor incorporates the different attitudes and approaches to office life looking to the future: it is dynamic, flexible and designed with essential yet distinctive visual styling. Strong points of Elinor are comfort and body-hugging feeling, thanks to the polyurethane injected foam seat and back. The result is a multitasking product characterized by a high level of aesthetic quality.

IT — Elinor sintetizza le diverse attitudini e modalità di vivere l'ufficio del futuro: è una seduta dinamica, flessibile, con un design essenziale ma riconoscibile. I suoi punti di forza sono il comfort e l'avvolgenza dati dall'imbottitura in schiumato poliuretano di sedile e schienale. Ne risulta un prodotto multitasking caratterizzato da una qualità estetica di alto livello.



Executive chair

Sedia esecutiva



Weight-activated synchro-tilt mechanism, integrated in the upholstered seat
Meccanismo sincronizzato autopesante, integrato nel sedile imbottito

3755





Die-cast
aluminium
Pressofusione
di alluminio



Injected
polyurethane foam
Schiumato
poliuretano

#PedraliPalaceofWonders

Salone del Mobile.Milano 2019
Milan, Italy

Project: Exhibition stand

Architect: CalviBrambilla

Products: Elinor executive chair and table,
Ester armchair, Ray coat stand





Pedrali Poetry of Elements

Orgatec 2018
Cologne, Germany

Project: Exhibition stand
Architect: CalviBrambilla
Products: Elinor executive chair

SIZES / DIMENSIONI

3755

Upholstered executive chair with high backrest, die-cast aluminium five-star base with castors, adjustable in height



FINISHES / FINITURE

fabrics / tessuti

→ see booklet for finishes
vedi catalogo finiture



aluminium / alluminio



LU
Polished
Lucidato



ST
Satinized
Satinato

AWARDS / PREMI



CERTIFICATES / CERTIFICAZIONI



According to EN 16139:2013 level 2, extreme
EN di riferimento 16139:2013 livello 2, estremo

Tempo

Time is precious

DESIGN
Jorge Pensi Design Studio, 2018

EN — Tempo is an operative chair with an essential and yet elegant design, able to fit in the most varied office life needs. An injection-moulded polypropylene shell supports the seat in the lumbar side, conferring continuity between the comfort and ergonomics of the upholstery, equally the functionality and dynamism of the plastic material.

IT — Tempo è una seduta operativa dal design essenziale ed elegante al tempo stesso, capace di vivere all'interno di contesti operativi differenti. Un guscio in polipropilene stampato a iniezione cinge il sedile nella zona lombare stabilendo una continuità tra il comfort e l'ergonomia dell'imbottito e la funzionalità e il dinamismo del materiale plastico.



Executive chair

Sedia esecutiva





#PedraliPalaceofWonders

Salone del Mobile.Milano 2019
Milan, Italy

Project: Exhibition stand

Architect: CalviBrambilla

Products: Boxie storage system, Flag coat stand, Arki-Table Adjustable table, Temps executive chair, Snooze sound absorbing panel

SIZES / DIMENSIONI

3765

Upholstered executive chair, die-cast aluminium five-star base with castors, adjustable in height



FINISHES / FINITURE

aluminium / alluminio

powder coated / verniciato

polypropylene / polipropilene



LU*
Polished
Lucidato

* Finitura bracciolo solo nero
Armrest finish black only



BI200



NERO



NE

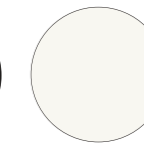

BI

fabrics / tessuti

→ see booklet for finishes
vedi catalogo finiture



AWARDS / PREMI



CERTIFICATES / CERTIFICAZIONI



According to EN 16139:2013 level 2, extreme
EN di riferimento 16139:2013 livello 2, estremo

Intrigo

A beautiful twist

DESIGN

Claudio Dondoli - Marco Pocci, 2015

EN — A combination of lines which twist harmoniously creating an involving, minimal silhouette. The main feature is represented by the die-cast aluminium which creates different sections for the backrest, armrests and legs.

IT — Un insieme di linee che si intersecano armonicamente dando origine ad una silhouette avvolgente e minimale. Intrigo è una seduta in cui la pressofusione di alluminio crea sezioni differenti per schienale, braccioli e gambe.



Armchair poltrona Intrigo
Table tavolo Concrete



Armchair

Poltrona





Seat cushion only
Cuscino per solo sedile

Waterproof seat
and back cushions
Cuscino per sedile e schienale
in tessuto waterproof





Oro Bistrot at NH Fori Imperiali

Rome, Italy

Project: Hotel

Products: Intrigo armchair, Nolita
barstool, Ypsilon table



Wine Bar Mus

Buttrio - Udine, Italy

Project: Wine bar

Products: Intrigo armchair,
Inox table



SIZES / DIMENSIONI

3715

Aluminium armchair



3715.5

Upholstered seat cushion only
WIDTH: 500

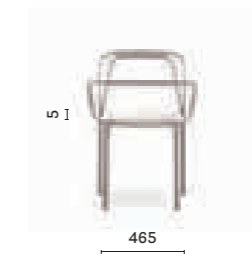

3715.20

Upholstered seat and back
cushions only



FINISHES / FINITURE

aluminium / alluminio

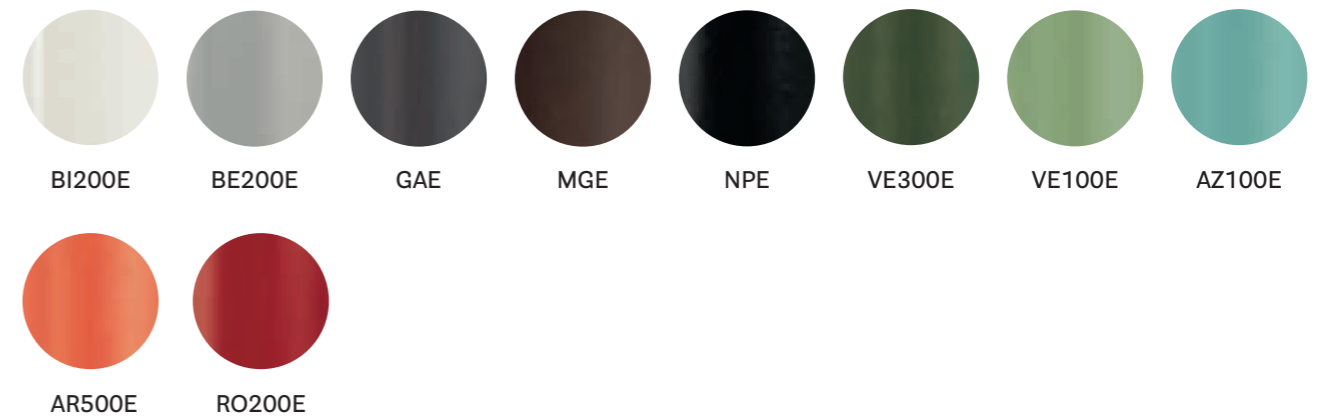

fabrics / tessuti



D31÷D39

→ see booklet for finishes
vedi catalogo finiture

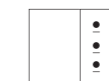

CERTIFICATES / CERTIFICAZIONI



According to EN 16139:2013 level 2, extreme
EN di riferimento 16139:2013 livello 2, estremo

Mya

Beyond the shapes

DESIGN
Claudio Dondoli - Marco Pocci, 2005

EN — Mya is a collection of chairs with a refined and filiform design, the polypropylene seat and back are inserted into the die-cast aluminium frame made up in one piece. Thanks to a stylistic research and a skilful combination of materials Mya is suitable for both outdoor and indoor environments.

IT — Mya è una collezione di sedute dal design raffinato e filiforme, con telaio in pressofusione di alluminio su cui si innestano una seduta e uno schienale in polipropilene. La ricerca stilistica e una sapiente combinazione di materiale rende Mya particolarmente adatta sia a contesti outdoor che indoor.





Side chair sedia Mya
Table tavolo Ypsilon, Ypsilon 4

Side chair

Sedia



SIDE CHAIR / SEDIA



Injection moulding
polypropylene backrest
profile
Profilo dello schienale
in polipropilene
stampato a iniezione

711



710

Upholstered seat and back,
polypropylene backrest profile
Seduta e schienale imbottiti
con cornice in polipropilene



Die-cast aluminium
armrests and frame
Braccioli e struttura
in pressofusione di alluminio

706/2



705/2

Armchair
Poltrona





716

Barstool
Sgabello





Salewa Headquarters

Bolzano, Italy

Project: Company canteen

Architect: CZA Cino Zucchi
Architetti + Park Associati

Products: Mya side chair,
Togo table, Kuadro table



Ella Restaurant Lenbachhaus Museum

München, Germany

Project: Café & Restaurant

Products: Mya side chair, Ikon table





Chateau Neercanne

Maastricht, Netherlands

Project: Hotel

Products: Mya armchair,
Togo table



SIZES / DIMENSIONI

700

Side chair, polypropylene seat and back, die-cast aluminium frame



705/2

Armchair, polypropylene seat and back, die-cast aluminium frame



716

Barstool, polypropylene seat and back, die-cast aluminium frame and steel footrest



701

Side chair, polypropylene seat and textilene back, die-cast aluminium frame

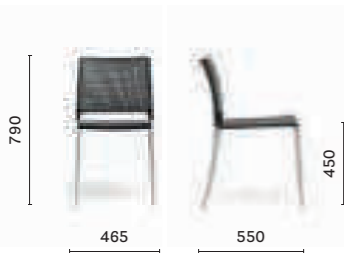

702

Side chair, upholstered seat and textilene back, die-cast aluminium frame

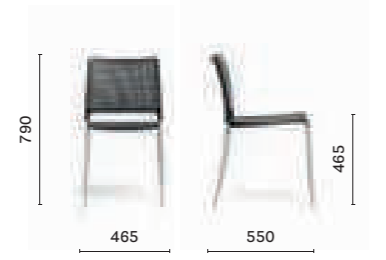

706/2

Armchair, polypropylene seat and textilene back, die-cast aluminium frame



710

Side chair, upholstered seat and back, die-cast aluminium frame



710/2

Armchair, upholstered seat and back, die-cast aluminium frame



711

Side chair, polypropylene backrest profile, upholstered seat and back, die-cast aluminium frame

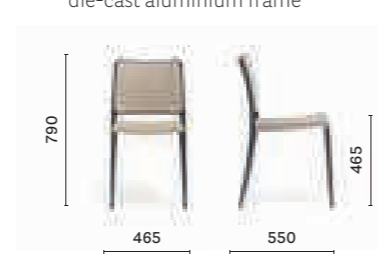

CG

Linking device



FINISHES / FINITURE

polypropylene / polipropilene



textilene / textilene

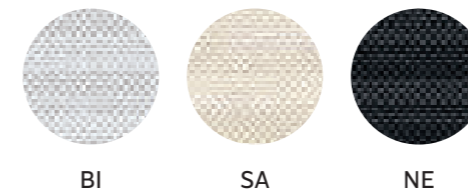

fabrics / tessuti

→ see booklet for finishes
vedi catalogo finiture



aluminium / alluminio



steel / acciaio



aluminium / alluminio



→ powder coated in the same colour of the seat and back
see booklet for finishes
verniciato in tinta con la scocca
vedi catalogo finiture



CERTIFICATES / CERTIFICAZIONI



According to UNI 10977/2002 level 5*
UNI di riferimento 10977/2002 livello 5*

Ice

Playful outline

DESIGN

Claudio Dondoli - Marco Poggi, 2003

EN — The collection has become a bestseller thanks to its versatility and soundness. The tubular legs in anodized aluminium are inserted into the polypropylene shell, this combination of materials makes the chair suitable for an array of varied furnishing needs, indoor and outdoor.

IT — Una collezione divenuta bestseller grazie alle sue caratteristiche di versatilità e solidità strutturale. Le gambe in alluminio anodizzato si innestano nella scocca in polipropilene, rendendo la seduta adatta a innumerevoli e svariati contesti d'uso.



Side chair

Sedia



Extruded anodized
aluminium legs
Gambe in estruso di
alluminio anodizzato
Ø 28 mm



Gas injection moulding
polypropylene shell
Monoscocca in
polipropilene stampata
con gas a iniezione



Armchair

Poltrona

Fire-retardant
version on request
Versione ignifuga
a richiesta



Stackable
Impilabile



Indoor & Outdoor

850

Barstool

Sgabello





Officine Maccaferri Headquarters

Bologna, Italy

Project: Company canteen

Architect: Progetto CMR

Product: Ice side chair



Madonnina

Milan, Italy

Project: Café & Restaurant

Product: Ice armchair

Mottini - E. Fermi

Romano di Lombardia, Italy

Project: School Canteen

Product: Ice side chair



SIZES / DIMENSIONI

800

Side chair, polypropylene shell, aluminium legs



800/CL1

Side chair, polypropylene shell, aluminium legs, fire-retardant grade



806

Barstool, polypropylene shell, steel legs



850

Armchair, polypropylene shell, aluminium legs



850/CL1

Armchair, polypropylene shell, aluminium legs, fire-retardant grade



840

Linking device



FINISHES / FINITURE

polypropylene / polipropilene

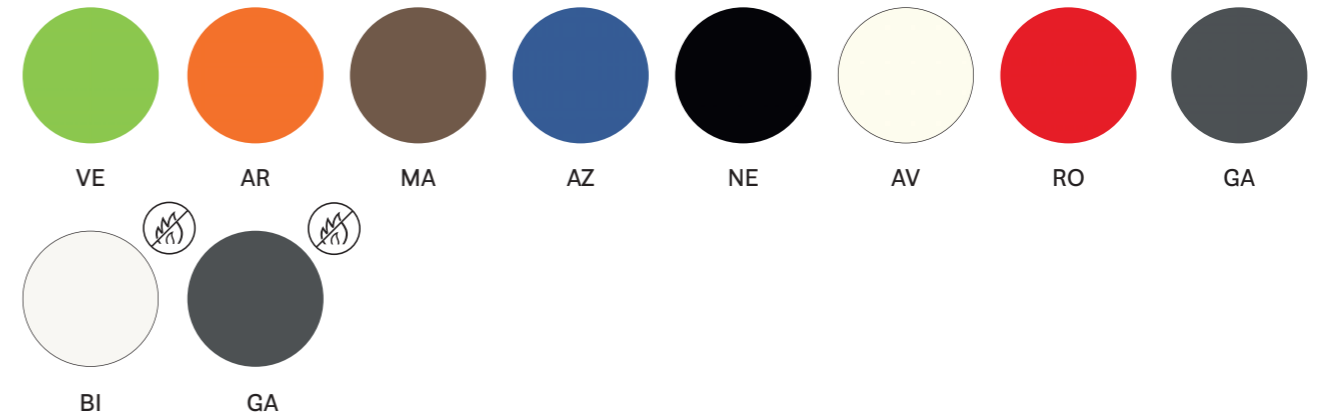

aluminium / alluminio



steel / acciaio

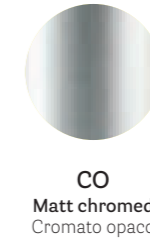

CERTIFICATES / CERTIFICAZIONI



According to UNI 15373:2007 level 3* - severe
UNI di riferimento 15373:2007 livello 3* - severo

Enjoy

Optimize your spaces

DESIGN
Claudio Dondoli - Marco Pocci , 2007

EN — Resistant and lightweight, Enjoy is a folding chair easy to handle and carry. Once folded takes up a minimal space of 95mm. Made of coloured polypropylene, suitable also for outdoor.

IT — Resistente e leggera, Enjoy è una sedia pieghevole estremamente semplice da movimentare che, una volta riposta, occupa uno spazio di soli 95 mm. Realizzata in polipropilene colorato, Enjoy si presta anche per utilizzi outdoor.



Chair

Sedia

Polypropylene charged with glass fiber, gas air moulded, textured surface
Realizzata interamente in polipropilene caricato fibra di vetro con texture della superficie



460





Kursaal Theatre

Manresa, Spain

Project: Theatre

Architect: Marc Borrós Camins
& Sonia Ros Mas

Products: Enjoy chair,
Inox table, Feel side chair

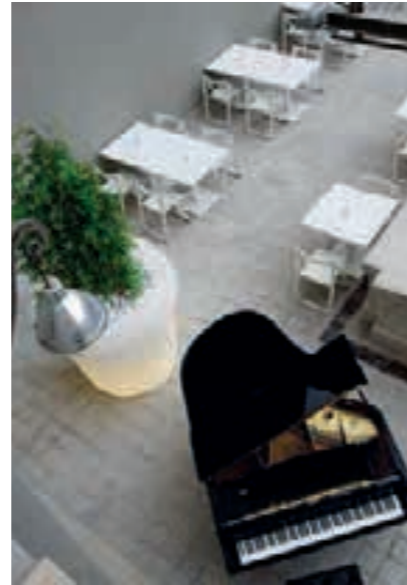

Museum of the History of Polish Jews

Warsaw, Poland

Project: Museum

Architects: Lahdelma & Mahlamäki
Architects, Kuryłowicz & Associates

Products: Enjoy chair,
Gliss armchair





Private house

Brescia, Italy

Project: Private house

Products: Enjoy chair, Matrix table

SIZES / DIMENSIONI

460

Polypropylene chair

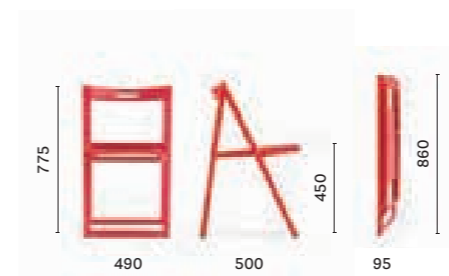

465-466

Steel trolley with or without wheels
WIDTH: 600

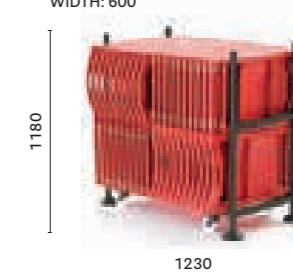

FINISHES / FINITURE

polypropylene / polipropilene

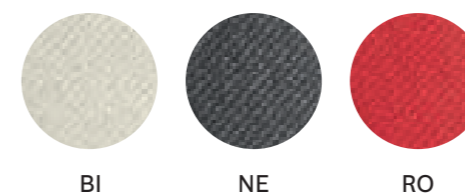

BI

NE

RO

CERTIFICATES / CERTIFICAZIONI



According to UNI 10977/2002 level 5*
UNI di riferimento 10977/2002 livello 5*

Tatami

Weaving inspiration

DESIGN
Claudio Dondoli - Marco Pucci, 2009

EN — Tatami is a collection of polypropylene chair which expresses desire to live at open air. The peculiar weaving of the shell guarantees comfort and encourages relax.
IT — La collezione di sedute in polipropilene Tatami esprime la voglia di vivere degli spazi aperti. Il caratteristico intreccio della scocca garantisce un comfort adeguato per favorire relax e benessere.



Armchair

Poltrona

Gas air moulding
polypropylene,
100% recyclable
Polipropilene stampato
con il supporto del gas,
100% riciclabile



306



Side chair

Sedia



305



Adaptation of a Forge

Stettino, Poland

Project: Private house

Architect: Loft Kolasinski

Product: Tatami armchair





Naples Botanical Garden

Naples, Florida

Project: Café & Restaurant

Products: Tatami armchair,
Jump table

Playa Blanca

Punta Cana, Santo Domingo

Project: Restaurant

Products: Tatami side chair,
Laja table, Pasha armchair,
Arki-Table, Ypsilon table,
Volt barstool, Ara Lounge armchair





Satra

Scicli, Italy

Project: Restaurant

Products: Tatami armchair,
Bold table, Allure armchair



SIZES / DIMENSIONI



FINISHES / FINITURE

polypropylene / polipropilene



CERTIFICATES / CERTIFICAZIONI



According to UNI 15373:2007 level 3* - severo
UNI di riferimento 15373:2007 livello 3* - severo



Happy

Unconventional seating

DESIGN
Claudio Dondoli - Marco Pocci, 2007

EN — With a funny and playful design, Happy is a collection of barstools in polypropylene that consists of two joined parts which can be detached, so as to obtain two different seat heights.

IT — Dalle forme giocose e divertenti, Happy è una collezione di sgabelli in polipropilene composti da due parti unite tra loro, con la possibilità di essere scorporate al fine di ottenere due diverse altezze di seduta.



Barstool

Sgabello

Gas assisted injection moulding
polypropylene, fiberglass charged
Polipropilene caricato fibra di vetro,
stampato a iniezione col supporto del gas



490



Prezi.com Headquarters

Budapest, Hungary

Project: Office
Product: Happy barstool



SIZES / DIMENSIONI

490

Polypropylene barstool



491

Polypropylene low stool



FINISHES / FINITURE

polypropylene / polipropilene



BI



GA



RO



AR

CERTIFICATES / CERTIFICAZIONI

CATAS

EN di riferimento 15373:2007 livello 3*, severo
secondo la EN 15373:2007 level 3*, severe

Kuadra XL

Less is more

DESIGN

Pedrali R&D, 2010

EN— The greater sizes, the lower back combined with a wide range of finishes feature Kuadra XL and make it even more versatile and comfortable. An iconic product characterized by the curved profile of the back which provides ergonomics and functionality.

IT— Le dimensioni rese più generose, lo schienale ribassato e l'ampia gamma di finiture connotano Kuadra XL, rendendola ancor più confortevole e versatile. Un prodotto iconico il cui profilo curvato dello schienale è garanzia di ergonomia e funzionalità.



Side chair sedia Kuadra XL
Table tavolo Arki-Table



Side chair

Sedia

Injection moulding
technopolymer shell
Scocca in tecnopolimero
stampato a iniezione



Stackable
Impilabile



Front shell with matt finish,
back shell with semi-glossy finish
Scocca frontale finitura opaca,
scocca posteriore finitura semi-lucida





Genuine or
regenerated
leather shell
Scocca in cuoio
naturale o
rigenerato



Upholstered front
shell version
Versione con scocca
frontale imbottita



Upholstered
seat version
Versione con
seduta imbottita



Armchair

Poltrona



High thickness upholstered shell,
steel handle in the back as option
Scocca imbottita ad alto spessore,
opzionale la maniglia in acciaio
sul retro dello schienale

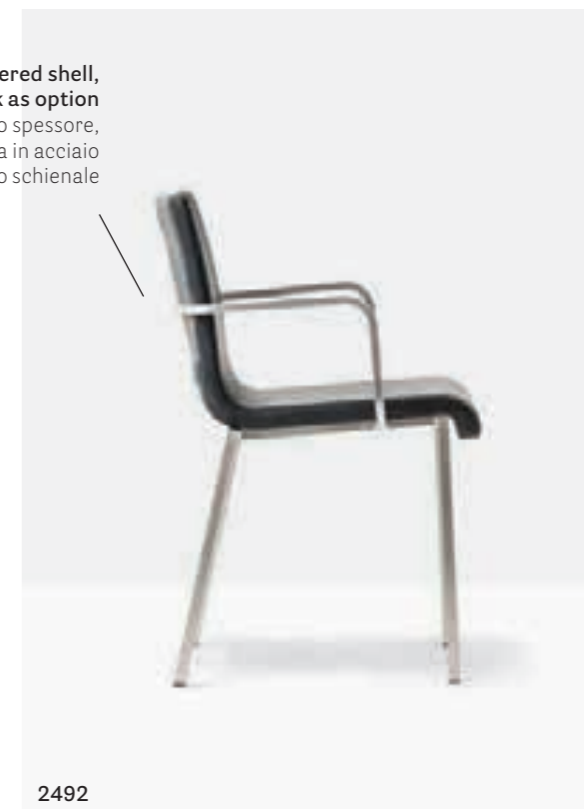



Barstool Sgabello



Modular seating

Seduta modulare



Private office

Brescia, Italy

Project: Private office

Products: Kuadra XL modular seating



The Morgan Library & Museum

New York, United States

Project: Library and museum
Products: Kuadra XL armchair,
Inox table



Fantoni Group

Osoppo - Udine, Italy

Project: Company canteen

Architect: Valle Architetti Associati

Products: Kuadra XL side chair



1più1

Avio - Trento, Italy

Project: Coffee bar

Products: Kuadra XL armchair,
Inox table, L001 lighting



SIZES / DIMENSIONI

2401

Side chair, technopolymer shell,
steel tube frame



2403

Side chair, technopolymer shell,
steel tube frame



2409

Side chair, technopolymer shell,
steel rod sled frame



2402

Armchair, technopolymer shell,
steel tube frame



2404

Armchair, technopolymer shell,
steel tube frame

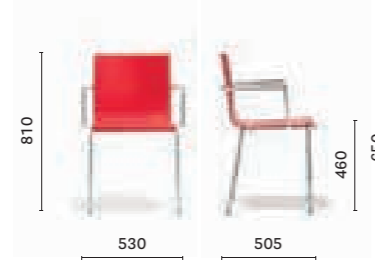

2415

Side chair, laminate shell,
steel tube frame



2417

Side chair, laminate shell,
steel tube frame



2416

Armchair, laminate shell,
steel tube frame



2418

Armchair, laminate shell,
steel tube frame



SIZES / DIMENSIONI

2411

Side chair, plywood shell,
steel tube frame



2411/A *

Side chair, plywood shell,
upholstered seat, steel tube frame



2441 *

Side chair, plywood shell
upholstered front side, steel
tube frame

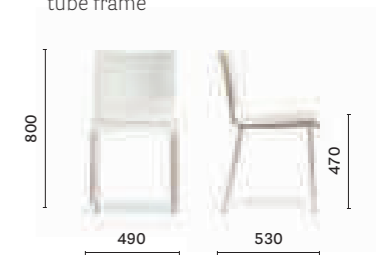

2413

Side chair, plywood shell,
steel tube frame



2413/A *

Side chair, plywood shell,
upholstered seat,
steel tube frame



2443 *

Side chair, plywood shell
upholstered front side, steel
tube frame



2412

Armchair, plywood shell,
steel tube frame



2412/A *

Armchair, plywood shell,
upholstered seat,
steel tube frame

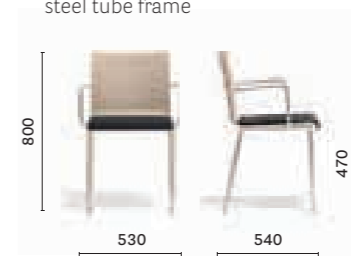

2442 *

Armchair, plywood shell
upholstered front side, steel
tube frame

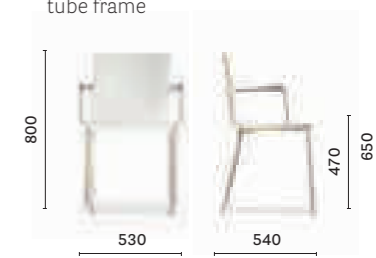

2414

Armchair, plywood shell,
steel tube frame



2414/A *

Armchair, plywood shell,
upholstered seat,
steel tube frame

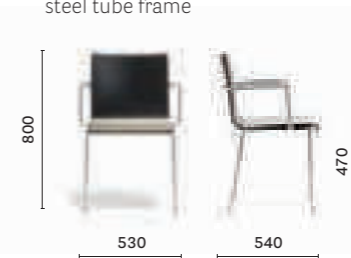

2444 *

Armchair, plywood shell
upholstered front side, steel
tube frame

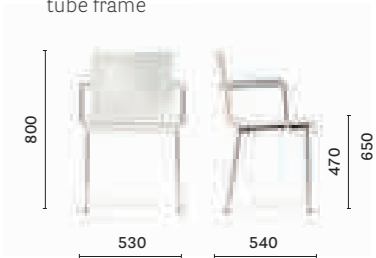

SIZES / DIMENSIONI

2419

Side chair, plywood shell,
steel rod sled frame



2421

Side chair, plywood shell,
steel tube frame

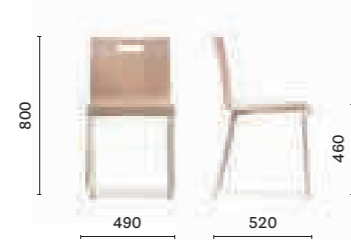

2423

Side chair, plywood shell,
steel tube frame



2431

Side chair, plywood shell,
steel tube frame



2433

Side chair, plywood shell,
steel tube frame



2461 *

Side chair, leather shell,
steel tube frame



2463 *

Side chair, leather shell,
steel tube frame



2462 *

Armchair, leather shell,
steel tube frame



2464 *

Armchair, leather shell,
steel tube frame



SIZES / DIMENSIONI

2481 *

Side chair, upholstered shell,
steel tube frame



2483 *

Side chair, upholstered shell,
steel tube frame



2491 *

Side chair, upholstered shell with steel
handle in the back, steel tube frame



2493 *

Side chair, upholstered shell
with steel handle in the back,
steel tube frame

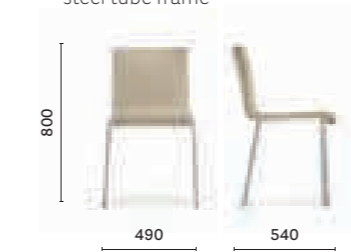

2482 *

Armchair, upholstered shell,
steel tube frame



2484 *

Armchair, upholstered shell,
steel tube frame

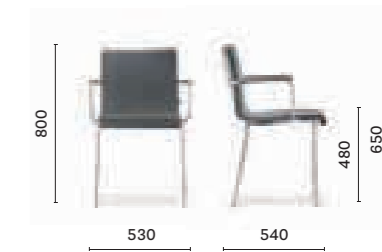

2492 *

Armchair, upholstered shell
with steel handle in the back,
steel tube frame



2494 *

Armchair, upholstered shell
with steel handle in the back,
steel tube frame



4429

Barstool, upholstered shell,
stainless steel base



* stackable with panel, on request / impilabile con pannello, a richiesta

SIZES / DIMENSIONI

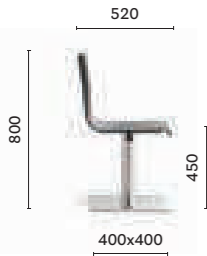

2603
Multiple seater, technopolymer shell, stainless steel frame



2604
Multiple seater, technopolymer shell, stainless steel frame

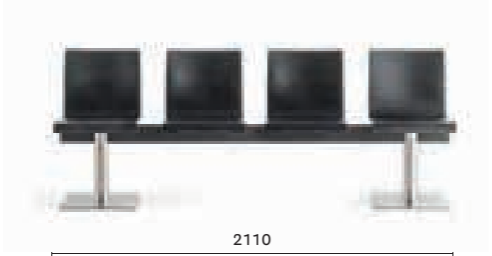

2605
Multiple seater, technopolymer shell, stainless steel frame



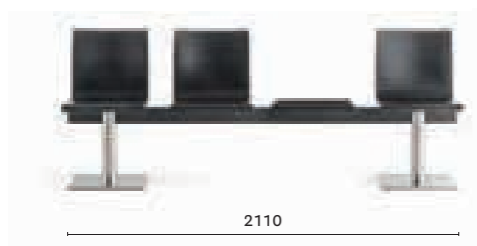

2606
Multiple seater, technopolymer shell, stainless steel frame, writing tablet



2607
Multiple seater, technopolymer shell, stainless steel frame, writing tablet

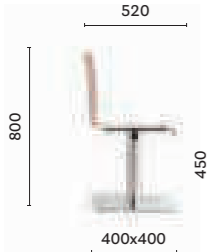

2613, 2614, 2615, 2616, 2617
Multiple seater, plywood shell, stainless steel frame, writing tablet, available in 3, 4 and 5 seats



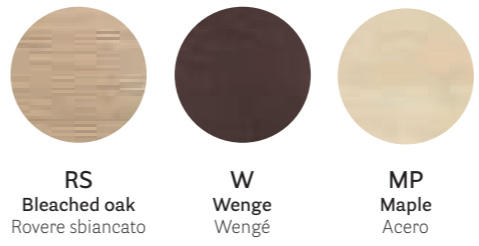

FINISHES / FINITURE

coated oak
rovere verniciato

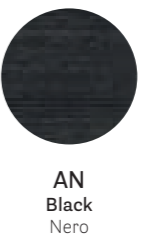

lacquered oak with visible grains
rovere laccato a poro aperto



technopolymer / tecnopolimero

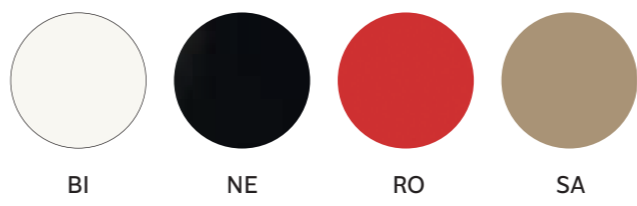

solid laminate tops / ripiani in stratificato



laminato / laminate

→ to be selected in ABET NCS colour card
da selezionare nella cartella colori
ABET NCS

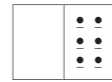

fabrics / tessuti

→ see booklet for finishes
vedi catalogo finiture

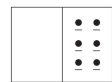

steel / acciaio

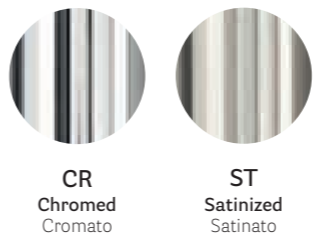

stainless steel / acciaio inox

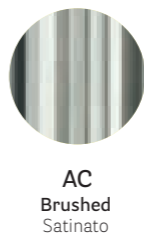

powder coated / verniciato

→ see booklet for finishes
vedi catalogo finiture

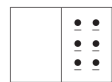

CERTIFICATES / CERTIFICAZIONI

CATAS EN di riferimento 15373:2007 livello 3°, severo
According to EN 15373:2007 level 3°, severe

Kuadra

Less is more

DESIGN

Pedrali R&D, 2001

EN — A very simple shell becomes an icon: from the plywood type in oak veneered with horizontal veins, up to technopolymer and methacrylate materials, to end up with the upholstery version. An innovative backrest that offers comfort, the curved lumbar profile allows an ergonomic rest. Kuadra is multitasking by definition, available with tubular frame in square section laser-cut, refined and innovative, or in the traditional versions in tubular frame or sled base in steel rod.

IT — Una scocca semplice diventata iconica: dalla versione in multistrato impiallacciato in precomposto di rovere con venatura orizzontale, fino a quelle in tecnopolimero, metacrilato e imbottito. Uno schienale innovativo: dal profilo lombare curvato, che permette un appoggio ergonomico, alto e confortevole. Multitasking per antonomasia, Kuadra è disponibile con struttura in tubo quadrato tagliato al laser, curata e innovativa, oppure nelle versioni più tradizionali in tubo e a slitta in tondino d'acciaio.



Side chair Sedia

Methacrylate shell
with opaline finish
Scocca in metacrilato
con finitura opaca



Steel tube frame
Struttura in tubo
d'acciaio
Ø 16 mm



Injection moulding
technopolymer shell
with semi-glossy finish
Scocca in tecnopolimero
stampato a iniezione
con finitura semilucida



Steel rod
sled frame
Struttura a slitta
in tondino d'acciaio
Ø 10 mm



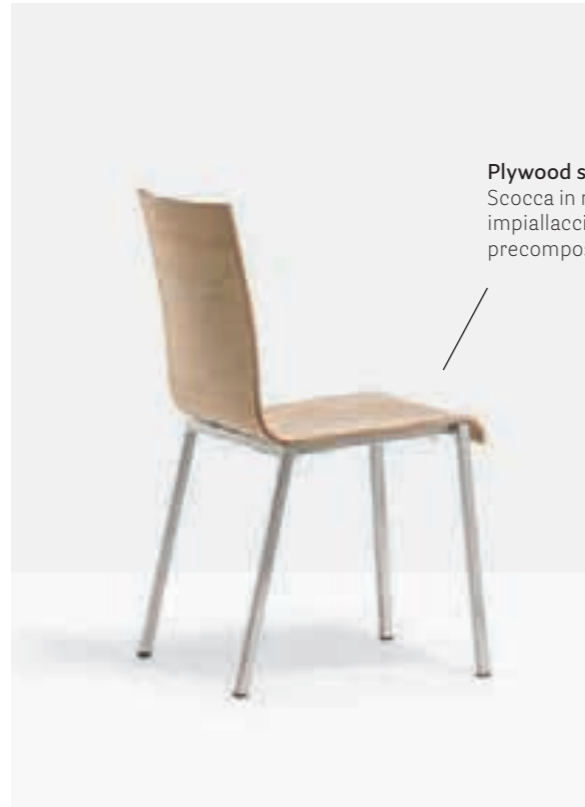

Plywood shell oak veneered
Scocca in multistrato
impiallacciato di rovere
precomposto



**Upholstered
seat version**
Versione con
seduta imbottita

1321/A



Steel tube frame
Struttura in tubo d'acciaio
20x20 mm

1321



SIDE CHAIR / SEDIA

Black Fenix® tablet with antipanic articulated joint
Tavoletta in Fenix® nero con snodo antipanico



Genuine or regenerated leather shell
Scocca rivestita in cuoio naturale o rigenerato



SIDE CHAIR / SEDIA

Upholstered shell, fabric or simil-leather covering
Scocca imbottita rivestita in tessuto o finta pelle



Armchair

Poltrona



Barstool

Sgabello





1126





Klima Hotel Milano Fiere

Milan, Italy

Project: Hotel

Products: Kuadra side chair
and barstool, Gliss armchair,
Inox table, Laja armchair,
Arki-Table



Mediaset

Milan, Italy

Project: Company canteen,
operations by Gruppo Pellegrini

Architect: E Plus Studio

Product: Kuadra side chair
and barstool, Inox table





IULM University

Milan, Italy

Project: University canteen,
operations by Gruppo Pellegrini

Architect: E Plus Studio

Product: Kuadra side chair
and barstool, Inox table

Hof Van Liere University

Antwerpen, Belgium

Project: University

Product: Kuadra side chair



SIZES / DIMENSIONI

1101

Side chair, tecnopolymer shell,
steel tube frame

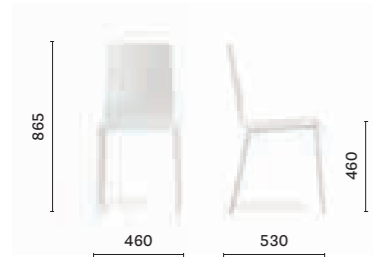

1151

Side chair, tecnopolymer shell,
steel tube frame



1158

Side chair, tecnopolymer shell,
steel rod sled frame



1115

Armchair, tecnopolymer shell,
steel tube frame



1102

Barstool, tecnopolymer shell,
steel tube frame

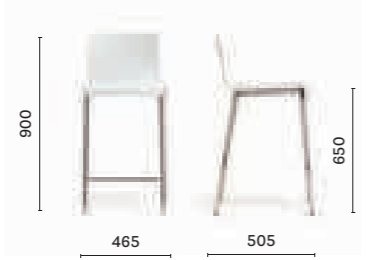

1106

Barstool, tecnopolymer shell,
steel tube frame

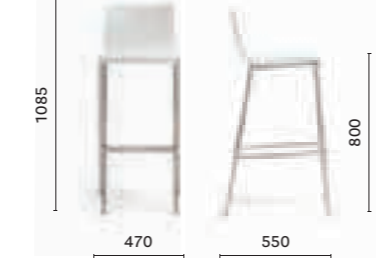

1112

Barstool, tecnopolymer shell,
steel tube frame



1116

Barstool, tecnopolymer shell,
steel tube frame

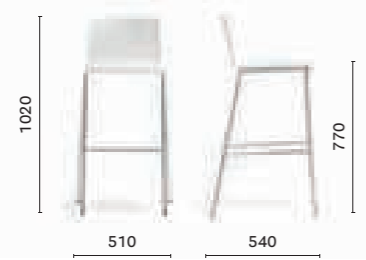

4415/KUTP

Barstool, tecnopolymer shell,
stainless steel central base

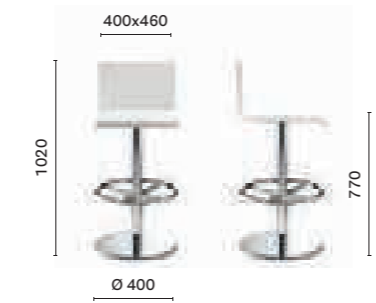

SIZES / DIMENSIONI

1170

Side chair, methacrylate shell,
steel tube frame

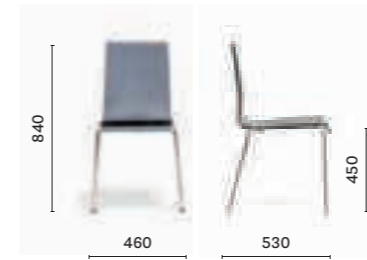

1171

Side chair, methacrylate shell,
steel tube frame

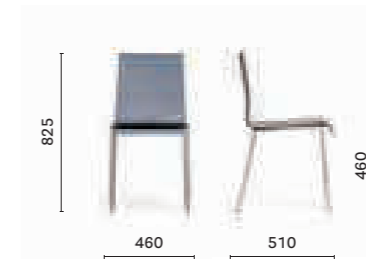

1172

Barstool, methacrylate shell,
steel tube frame



1176

Barstool, methacrylate shell,
steel tube frame

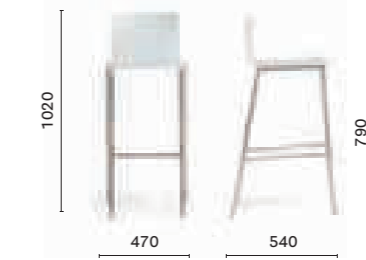

1182

Barstool, methacrylate shell,
steel tube frame

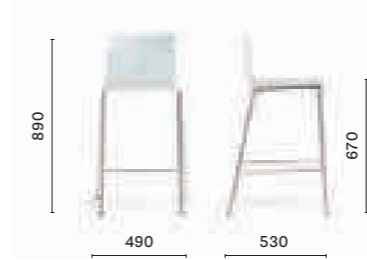

1186

Barstool, methacrylate shell,
steel tube frame

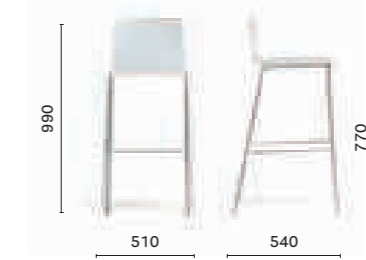

SIZES / DIMENSIONI

1301

Side chair, plywood shell,
steel tube frame

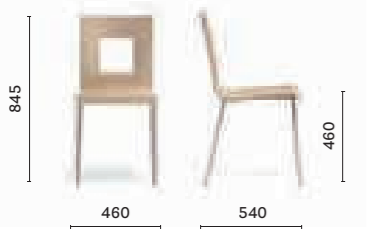

1311

Side chair, plywood shell,
steel tube frame

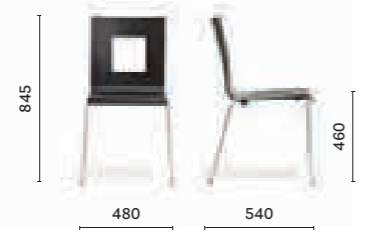

1308

Side chair, plywood shell,
steel rod sled frame



1321

Side chair, plywood shell,
steel tube frame

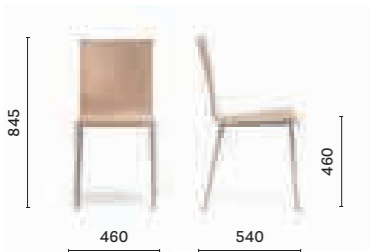

1321/A *

Side chair, plywood shell,
upholstered seat, steel tube frame



1331

Side chair, plywood shell,
steel tube frame



1335

Armchair, plywood shell,
steel tube frame



1328

Side chair, plywood shell,
steel rod sled frame



1329

Side chair, plywood shell,
steel tube frame, black Fenix® tablet

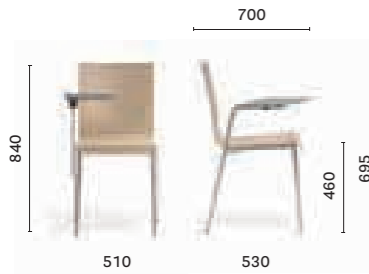

1329/TP

Side chair, technopolymer shell,
steel tube frame, black Fenix® tablet



SIZES / DIMENSIONI

1395

Side chair, plywood shell,
steel tube frame



1341

Side chair, plywood shell,
steel tube frame

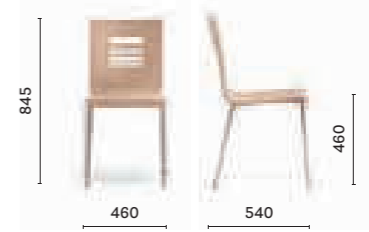

1351

Side chair, plywood shell,
steel tube frame



1358

Side chair, plywood shell,
steel rod sled frame



1322

Barstool, plywood shell,
steel tube frame



1326

Barstool, plywood shell,
steel tube frame



1332

Barstool, plywood shell,
steel tube frame

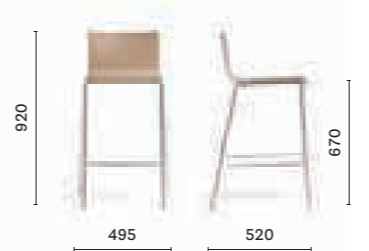

1336

Barstool, plywood shell,
steel tube frame



4408

Barstool, plywood shell, steel
central base



4417/KU

Barstool, plywood shell, stainless
steel central base



4429

Barstool, plywood shell, steel
central base



SIZES / DIMENSIONI

1281 *

Side chair, leather shell,
steel tube frame

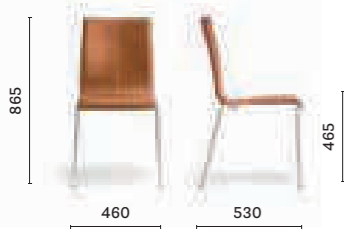

1291 *

Side chair, leather shell,
steel tube frame

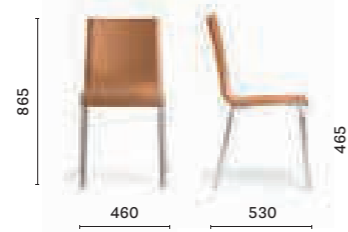

1298 *

Side chair, leather shell,
steel rod sled frame

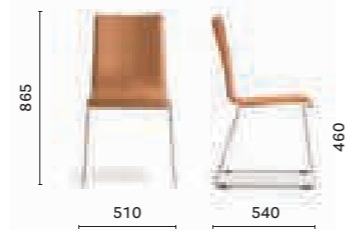

1285 *

Armchair, leather shell,
steel tube frame



1322/F

Barstool, leather shell,
steel tube frame



1326/F

Barstool, leather shell,
steel tube frame



1332/F

Barstool, leather shell,
steel tube frame



1336/F

Barstool, leather shell,
steel tube frame



4408/F

Barstool, leather shell,
steel central base



4427/F

Barstool, leather shell,
steel central base



4429/F

Barstool, leather shell,
steel central base



SIZES / DIMENSIONI

1010 *

Side chair, upholstered
shell, steel tube frame

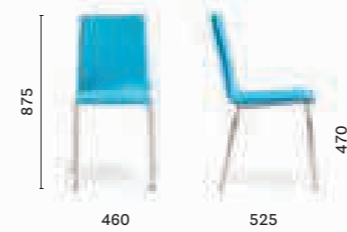

1051 *

Side chair, upholstered
seat, steel tube frame

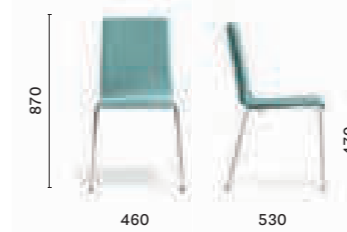

1058 *

Side chair, upholstered shell,
steel rod sled frame

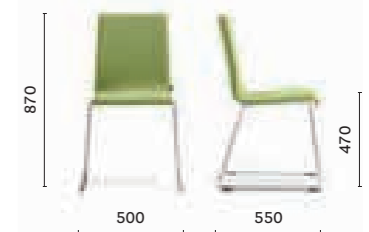

1055 *

Armchair, upholstered shell,
steel tube frame

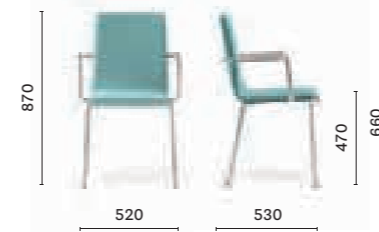

1122

Barstool, upholstered shell,
steel tube frame

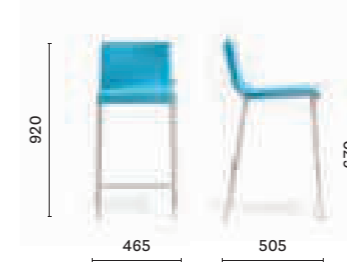

1126

Barstool, upholstered shell,
steel tube frame

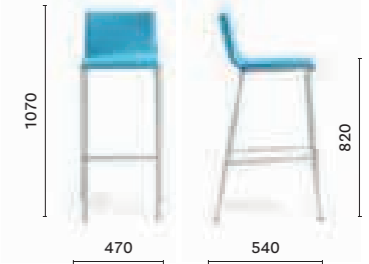

1132

Barstool, upholstered shell,
steel tube frame



1136

Barstool, upholstered shell,
steel tube frame

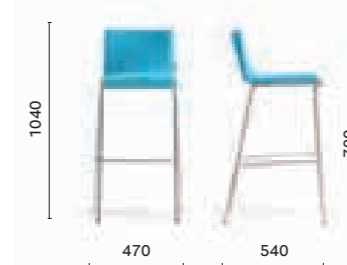

CG

Linking device



* stackable with panel, on request / impilabile con pannello, a richiesta

methacrylate / metacrilato



OP BT RT MT GG



TR GL AL RL

technopolymer / tecnopolimero

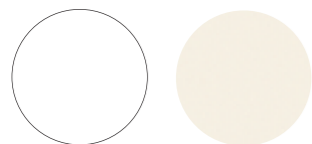

BI AV

coated oak / rovere verniciato

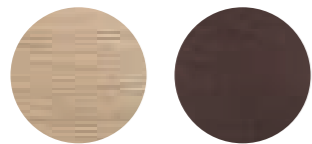

RS
Bleached oak
Rovere sbiancato

W
Wenge
Wengé

lacquered oak with visible grains
rovere laccato a poro aperto



AN
Black
Nero

fabrics / tessuti

→ see booklet for finishes
vedi catalogo finiture

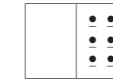

steel / acciaio



ST
Satinized
Satinato

CR
Chromed
Cromato

CO
Matt chromed
Cromato opaco

stainless steel / acciaio inox



AC316
AISI 316 for outdoor
AISI 316 oer esterno

AC
Brushed
Satinato

linking device / gancio di collegamento



CR
Chromed
Cromato

powder coated / verniciato

→ see booklet for finishes
vedi catalogo finiture



CERTIFICATES / CERTIFICAZIONI

CATAS UNI di riferimento 15373:2007 livello 3* - severo
According to UNI 15373:2007 level 3* - severo

Kuadra polycarbonate

Less is more

DESIGN
Pedrali R&D, 2001

EN — The iconic Kuadra shell is available also in polycarbonate material. The essential glamour stands out for versatility, its curved backrest is a distinguished element, functional and suitable for contemporary furnishing solutions.

IT — L'iconica scocca di Kuadra viene proposta anche in polycarbonato. L'eleganza essenziale e un'anima versatile, la cui curva dello schienale rappresenta un elemento distintivo e caratterizzante, la rendono ideale per ambienti funzionali e contemporanei.



Side chair
Sedia



Hotel Monaco & Grand Canal

Venice, Italy

Project: Hotel

Product: Kuadra side chair





Area Docks

Brescia, Italy

Project: Restaurant

Product: Kuadra side chair

Barcelona El Prat Airport

Barcelona El Prat, Spain

Project: Café & Restaurant

Architect: Ricardo Bofill

Products: Kuadra side chair, Inox table, Cube barstool



SIZES / DIMENSIONI

1271

Side chair, polycarbonate shell, steel tube frame

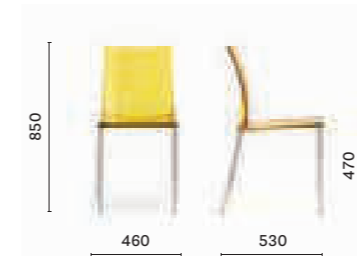

1271/ CL1

Side chair, polycarbonate shell, steel tube frame, fire-retardant grade



FINISHES / FINITURE

polycarbonate / policarbonato

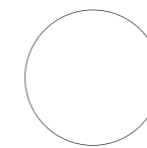

BI



NE



TR



GT



AT



RT

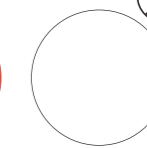

BI



TR

steel / acciaio



CR
Chromed
Cromato



ST
Satinized
Satinato

powder coated / verniciato

→ see booklet for finishes
vedi catalogo finiture



CERTIFICATES / CERTIFICAZIONI



UNI di riferimento 15373:2007 livello 3* - severo
According to UNI 15373:2007 level 3* - severe

Box

Geometric shapes

DESIGN
Pedrali R&D, 2008

EN — Rigorous outlines along with the use of different materials, as wood and metal combined with the upholstery, the seat offers different proportions so as to create a complete and multipurpose collection.

IT — Box può contare su forme rigorose e sull'utilizzo di materiali diversi quali legno, metallo e imbottito. La seduta si declina in varie proporzioni al fine di creare una collezione versatile e completa.



Armchair Poltrona



Sandwich panel core in veneered oak and solid oak legs
Struttura in legno tamburato impiallacciato e gambe in massello di rovere

Steel tube sled frame
Struttura a slitta in tubo d'acciaio 20x20 mm



Lounge armchair Poltrona lounge



Seat height
Altezza seduta
415 mm

Sofa
Divano



Two-seat upholstered sofa
Divano imbottito a due posti

746

Barstool Sgabello



Seat height
Altezza seduta
785 mm

747

La Térmica

Almería, Spain

Project: Café & Restaurant
Products: Box armchair and sofa, Modus modular seating, Hx barstool, Inox table





Boardwalk at Dubai Creek Golf & Yacht Club

Dubai, UAE

Project: Restaurant

Architect: PDI Prospect Design
International JLT

Products: Box armchair,
Inox table



SIZES / DIMENSIONI

740

Armchair, oak wood shell, upholstered seat and back, steel tube frame

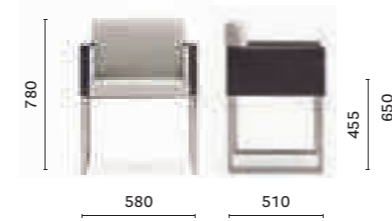

742

Armchair, oak wood shell and legs, upholstered seat and back



741

Lounge armchair, oak wood shell, upholstered seat and back, steel tube frame

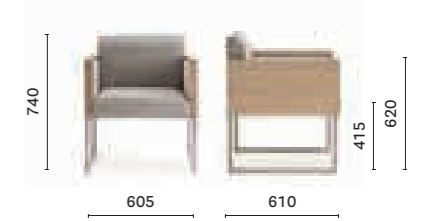

747

Barstool, oak wood shell, upholstered seat and back, steel tube frame

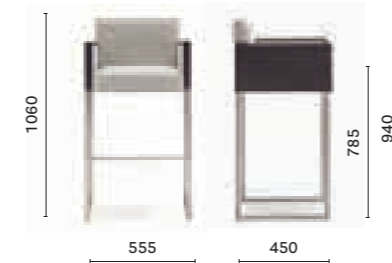

746

Sofa, oak wood shell, upholstered seat and back, steel tube frame

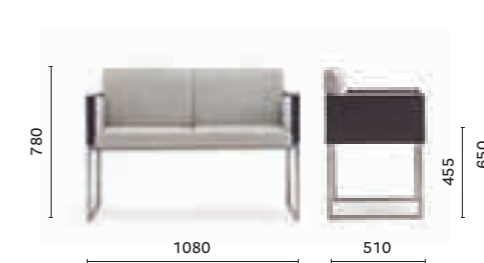

FINISHES / FINITURE

coated oak
rovere verniciato

lacquered oak with visible grains
rovere laccato a poro aperto

steel
acciaio



RS
Bleached oak
Rovere sbiancato

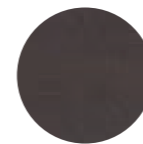

W
Wenge
Wengé



N1
Light walnut
Noce chiaro



BI
White
Bianco



GC
Light grey
Grigio chiaro



ST
Satinized
Satinato

fabrics / tessuti

→ see booklet for finishes
vedi catalogo finiture



CERTIFICATES / CERTIFICAZIONI



UNI di riferimento 15373:2007 livello 3* - severo
According to UNI 15373:2007 level 3* - severe

Jil

Luxury comfort

DESIGN
Enrico Franzolini, 2011

EN — An elegant and luxury collection which distinguishes for the refined care to the details, the well-balance use of the solid oak combined with soft upholstery gives to Jil a touch of glamour.
IT — Una famiglia di sedute importanti, dal sapore "luxury", caratterizzata da una raffinata attenzione ai dettagli. L'equilibrio tra l'utilizzo del legno di rovere, abbinato alle morbide imbottiture, caratterizza Jil per eleganza e buon gusto.



Lounge armchair poltrona lounge Jil
Coffee table tavolino Code
Lighting lampada L001



Armchair Poltrona



Lounge armchair Poltrona lounge



Side chair
Sedia



Barstool
Sgabello





Klima Hotel Milano Fiere

Milan, Italy

Project: Hotel

Products: Jil armchair and lounge
armchair, Inox table, L002 lighting,
Kuadra side chair and barstool,
Gliss armchair, Laja armchair,
Arki-Table





Cadebasi Franciacorta

Erbusco, Italy

Project: Café & Restaurant

Products: Jil barstool, Babila side chair,
Arki-Base table, Arki-Table, L001 lighting

SIZES / DIMENSIONI

520

Oak wood side chair,
upholstered seat and back



521

Oak wood lounge armchair,
upholstered seat and back



525

Oak wood armchair,
upholstered seat and back

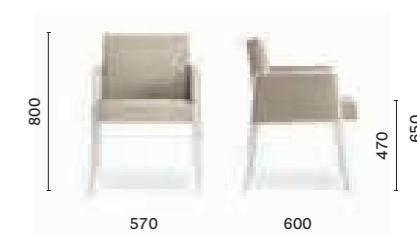

526

Oak wood barstool,
upholstered seat and back



FINISHES / FINITURE

coated oak
rovere verniciato

lacquered oak with visible grains
rovere laccato a poro aperto



RS
Bleached oak
Rovere sbiancato

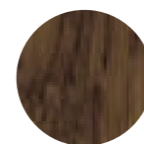

W
Wenge
tobacco shade
Wengé
tinto tabacco



N1
Light walnut
Noce chiaro



BI
White
Bianco



GC
Light grey
Grigio chiaro

fabrics / tessuti

→ see booklet for finishes
vedi cartella tessuti



CERTIFICATES / CERTIFICAZIONI



UNI di riferimento 15373:2007 livello 3* - severo
According to UNI 15373:2007 level 3* - severo

Cube

Geometric shapes

DESIGN
Pedrali R&D, 2002

EN — Cube barstool design is inspired by a pure and simple geometrical language. It has a plywood or upholstered seat combined with a steel tubular frame in square section. Thanks to its compact structure, it is conceived for optimizing the interior furnishing spaces.

IT — Lo sgabello Cube trae ispirazione da un linguaggio geometrico puro e semplice. Il sedile è in multistrato oppure imbottito, mentre il telaio è in tubolare di acciaio a sezione quadrata. Grazie alla sua forma compatta, è pensato per ottimizzare gli spazi all'interno dei quali viene collocato.



Barstool

Sgabello



Seat height
Altezza seduta
800 mm



Veneered oak
plywood seat
Seduta in multistrato
di rovere impiallacciato





Google Headquarters

Dublin, Ireland

Project: Office

Architects: Camenzind Evolutions,
Henry J. Lyons Architects

Products: Cube barstool,
Day Dream chair, Woody barstool,
Pasha armchair, Liberty table,
Ice side chair, Gliss armchair,
Pasha armchair, Kuadra barstool, Young
side chair and barstool, Dream barstool,
Island lounge seating, Dream table, Inox
table

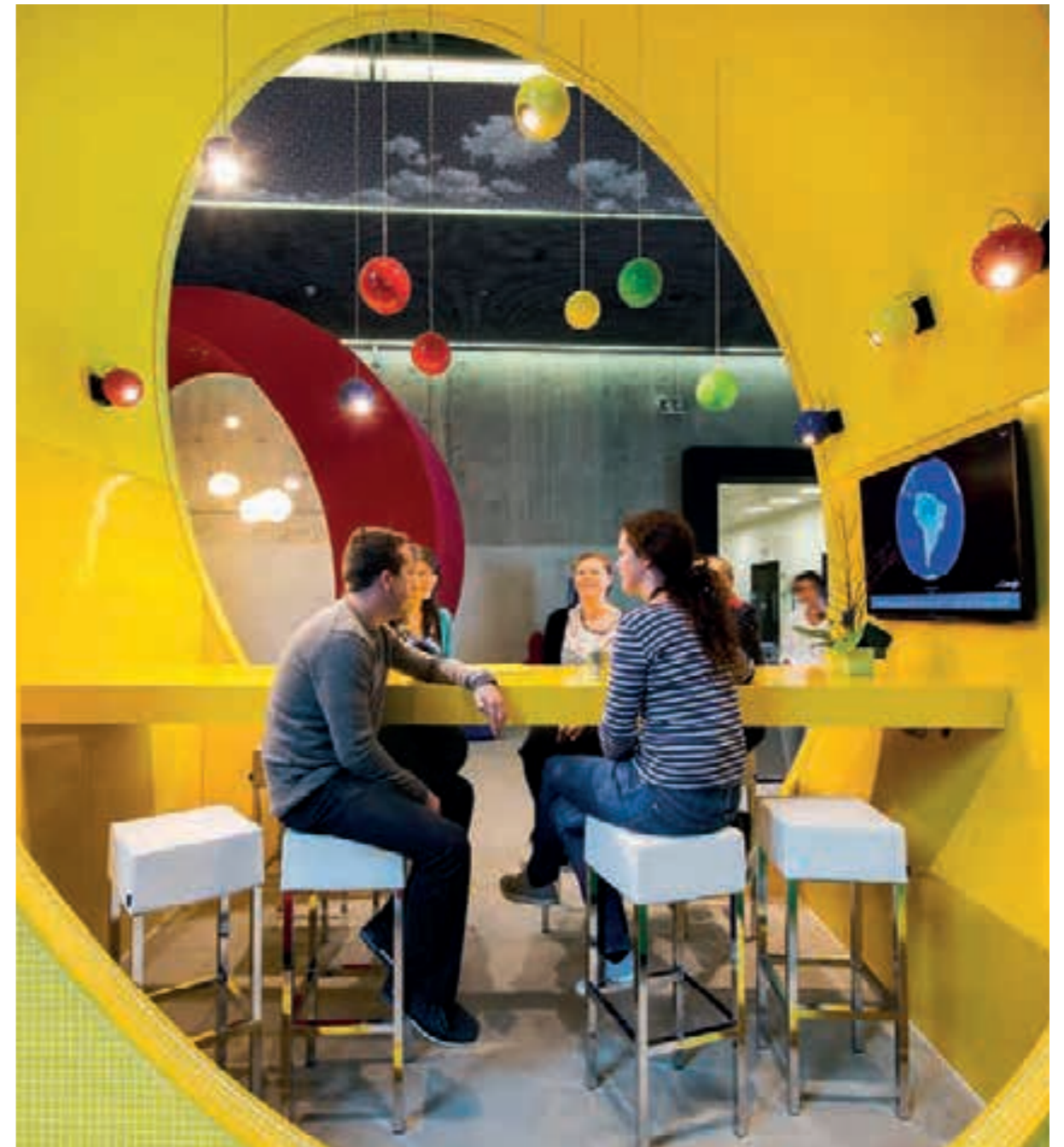

Caffè Moak Headquarters

Modica, Italy

Project: Office
Products: Cube barstool,
Twig chair, Inox table,
L001 lighting



Barcelona El Prat Airport

Barcelona El Prat, Spain

Project: Café & Restaurant

Architect: Ricardo Bofill

Products: Cube barstool,
Kuada side chair, Inox table



Temporary installation

Brescia, Italy

Project: Coffee bar

Products: Cube barstool

SIZES / DIMENSIONI

1400

Barstool, upholstered seat, steel tube frame

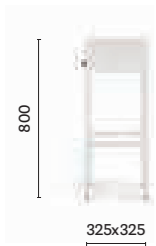

1401

Barstool, upholstered seat, steel tube frame

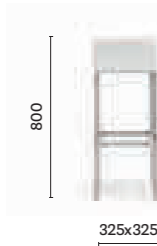

1401/RV

Barstool, oak plywood seat, steel tube frame

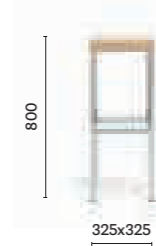

1402

Barstool, upholstered seat, steel tube frame



1402/RV

Barstool, oak plywood seat, steel tube frame

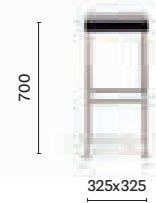

1403

Low stool, upholstered seat, steel tube frame



1403/RV

Low stool, oak plywood seat, steel tube frame

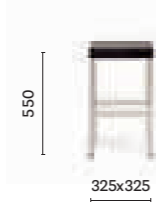

1451

Barstool, upholstered seat, steel tube frame

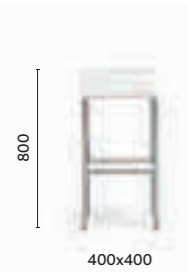

1453

Low stool, upholstered seat, steel tube frame



1461

Barstool, upholstered seat and back, steel tube frame



FINISHES / FINITURE

coated oak / rovere verniciato



RS
Bleached oak
Rovere sbiancato



W
Wenge
Wengé

fabrics / tessuti

→ see booklet for finishes
vedi catalogo finiture

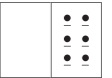

steel / acciaio



CR
Chromed
Cromato



ST
Satinized
Satinato



OA
Antique brass
Ottone anticato

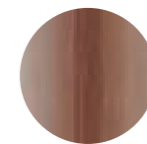

RM
Antique copper
Rame anticato



EC
Corten effect
Effetto corten

powder coated / verniciato



BI



NERO



TR
Transparent
Trasparente

powder coated / verniciato

→ see booklet for finishes
vedi catalogo finiture



Hx

Stainless steel alphabet

DESIGN

Pedrali R&D, 2003

EN—A pure and functional geometry studied to offer a great comfort. The thick upholstered seat, with or without the backrest, is combined with a central pedestal base in stainless steel.

IT—Una geometria pura e funzionale che offre elevato comfort alla seduta. Il sedile imbottito ad alto spessore di HX, con e senza schienale, è abbinato ad un telaio a base centrale in acciaio inox.



Barstool

Sgabello



Guthrie Theatre

Minneapolis, USA

Project: Theatre

Architect: Ateliers Jean Nouvel

Product: Hx barstool, Inox table, Mya side chair



SIZES / DIMENSIONI

4445F

Barstool, upholstered seat, stainless steel base

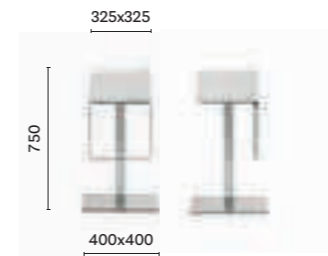

4445G

Barstool, upholstered seat, stainless steel base

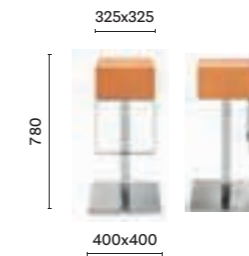

4446

Barstool, upholstered seat, stainless steel base

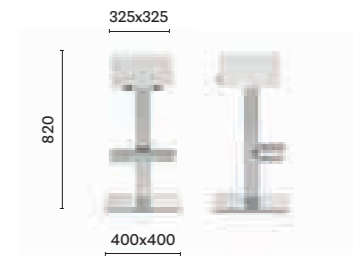

4447

Barstool, upholstered seat and back, stainless steel base

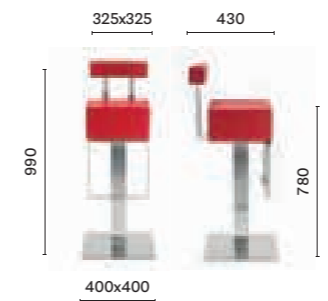

4448

Barstool, upholstered seat and back, stainless steel base

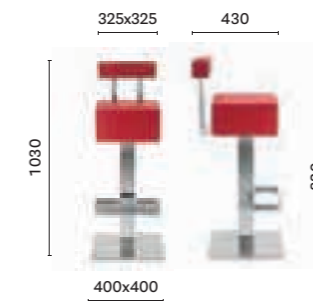

4449

Barstool, upholstered seat and back, stainless steel base

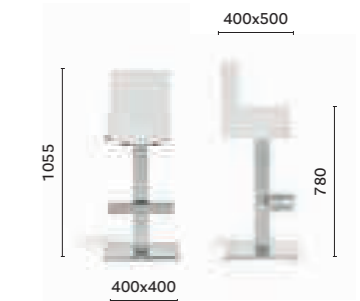

FINISHES / FINITURE

fabrics / tessuti

→ see booklet for finishes
vedi catalogo finiture



powder coated / verniciato

→ see booklet for finishes
vedi catalogo finiture

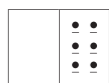

stainless steel / acciaio inox



AC
Brushed
Satinato

Lotus

Pure essence

DESIGN
Pedrali R&D, 2006

EN — Lotus barstool has a central pedestal base in circular shape in two different dimensions, frame in stainless steel with upholstered seat fixed or swivel versions. Lotus stands out for a simple and pure design suitable for the most varied furnishing needs.

IT — Lotus è uno sgabello a fusto centrale proposto con base circolare in due diverse dimensioni. Realizzato in acciaio, con sedile imbottito fisso o girevole, Lotus si caratterizza per una forma semplice e pura, che lo rende particolarmente adatto ad ogni soluzione d'arredo.



Barstool Sgabello

Polyurethane foam
upholstered seat
Seduta imbottita in
poliuretano espanso



4416

Temporary installation

Brescia, Italy

Project: Coffee bar

Products: Lotus barstool,
Sign armchair, Inox table



SIZES / DIMENSIONI

4415F

Barstool, upholstered seat,
stainless steel central base

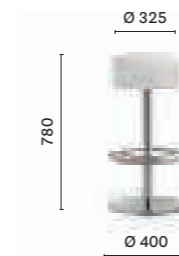

4415G

Barstool, upholstered seat,
stainless steel central base

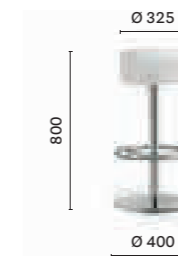

4416

Barstool, upholstered seat,
stainless steel central base

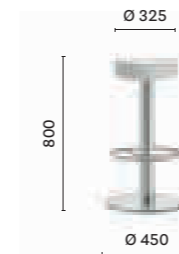

4417

Barstool, upholstered seat,
stainless steel central base

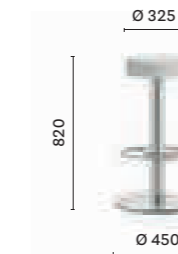

FINISHES / FINITURE

fabrics / tessuti

→ see booklet for finishes
vedi catalogo finiture

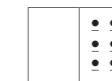

S_ZETA

S_TX



stainless steel / acciaio inox



AC
Brushed
Satinato

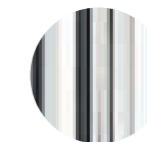

CR
Chromed
Cromato

powder coated / verniciato

→ see booklet for finishes
vedi catalogo finiture



Dream

Tulip silhouette

DESIGN
Pedrali R&D, 1998

EN — Dream is a collection of barstools featured by central pedestal and round base equipped with upholstered seat in high thickness. Its main features are compact dimensions and a slender silhouette. Dream satisfies the contemporary furnishing needs.

IT — Dream è una collezione di sgabelli a fusto centrale e base circolare dotato di un sedile imbottito ad alto spessore. Dalle dimensioni contenute e dalla silhouette slanciata, lo sgabello Dream risponde alla più moderne esigenze d'arredo.



Barstool

Sgabello

Steel base and column,
cast aluminium footrest
Base e colonna in acciaio,
poggiapiedi in fusione di alluminio



4816



4833F



Temporary installation

Brescia, Italy

Project: Coffee bar

Product: Dream barstool

SIZES / DIMENSIONI

4813

Low stool, upholstered seat, steel base



4816

Barstool, upholstered seat, steel base and die-cast aluminium footrest

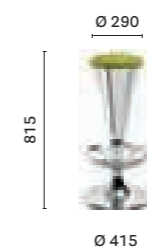

4833F

Low stool, upholstered seat, steel base

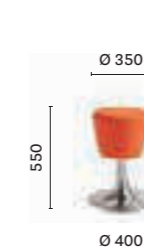

4833G

Low stool, upholstered seat, steel base

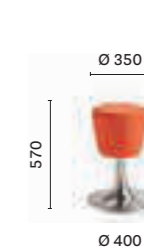

4836

Barstool, upholstered seat, steel base and die-cast aluminium footrest



4837

Barstool, upholstered seat, steel base and die-cast aluminium footrest



FINISHES / FINITURE

fabrics / tessuti

→ see booklet for finishes
vedi catalogo finiture



S_ZETA

S350CON



steel / acciaio



ST
Satinized
Satinato



CR
Chromed
Cromato

aluminium / alluminio

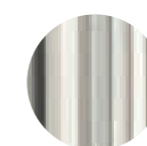

ST
Satinized
Satinato



LU
Polished
Lucidato

powder coated / verniciato

→ see booklet for finishes
vedi catalogo finiture



Zx

Stainless steel alphabet

DESIGN
Pedrali R&D

EN — An oblique steel column, diagonally cut to the base, it is the peculiar cut for ZX barstools. A tribute to innovative graphic solutions along with a defined design, are the key elements of this model.

IT — Una colonna obliqua in acciaio, tagliata in diagonale alla base, è il tratto distintivo dello sgabello ZX. Un tributo a soluzioni grafiche innovative e un design riconoscibile, sono gli elementi di spicco di questo modello.



Barstool Sgabello



4478



Brushed stainless steel base and column
Base e colonna in acciaio inox satinato

4476

4476

Barstool, upholstered seat, stainless steel base

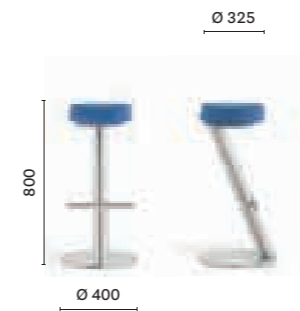

4478

Barstool, upholstered seat and backrest, stainless steel base

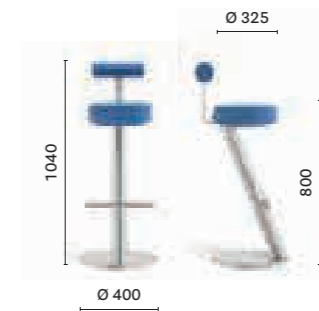

stainless steel / acciaio inox



AC
Brushed
Satinato

fabrics / tessuti

→ see booklet for finishes
vedi catalogo finiture

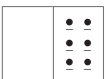

Tonda

American barstool

DESIGN
Pedrali R&D, 1993

EN — Tonda barstool is inspired by American Sixties, thanks to its design and steel tube central base, it comes with upholstered seat with a pop touch.

IT — Lo sgabello Tonda si ispira all'America degli anni Sessanta grazie alla sua forma e alla base centrale in acciaio, a sostegno del sedile imbottito dall'anima pop.



Heineken Italia

Milan, Italy

Project: Office

Architects: DEGW - brand of Lombardini22
(Interior Design & Space Planning)

Products: Tonda barstool and table,
Brera barstool, Feel side chair, Pasha armchair,
Ikon table, Plus armchair, Lounge armchair and
sofa, Time Out lighting



Google Headquarters

Dublin, Ireland

Project: Office

Architects: Camenzind Evolutions,
Henry J. Lyons Architects

Products: Tonda barstool,
Day Dream chair, Cube barstool,
Pasha armchair, Woody barstool,
Liberty table, Ice side chair,
Gliss armchair, Kuadra barstool,
Young side chair and barstool,
Dream barstool, Island lounge seating,
Dream table, Inox table



SIZES / DIMENSIONI

4156

Barstool, upholstered seat, steel base

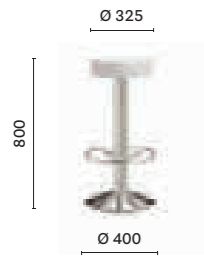

4157

Barstool, upholstered seat, steel base

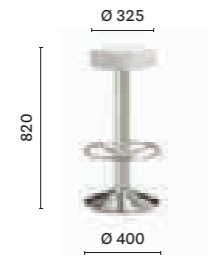

4706

Barstool, upholstered seat, cast iron base

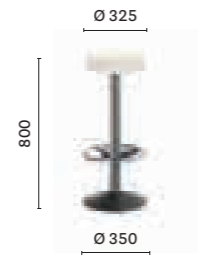

FINISHES / FINITURE

fabrics / tessuti

→ see booklet for finishes
vedi catalogo finiture



S_ZETA

S_TX

S350CON

S325FC



steel / acciaio

stainless steel / acciaio inox



CR
Chromed
Cromato



ST
Satinized
Satinato

powder coated / verniciato

→ see booklet for finishes
vedi catalogo finiture

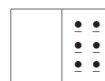

Pedrali Sedute 03 | Edition 2020

Creative & design direction Leftloft

Print Intese Grafiche

Copyright © 2020, Pedrali S.p.A. All rights reserved

Photo credits

BHM Studio
Beppe Brancato
Mattia Pagani
Ottavio Tomasini

Daniele Domenicali
Adriano Ferrara
José Hevia
Roberto Patti

Zydów Polskich
Juha Salminen
Alberto Sinigaglia
Krzysztof Strażyński

Dario Tettamanzi
Tamás Török
Peter Würmli
Nava-Rapacchietta

Thanks to

Alessi
Andreotti Chiara
Bohem Fiori
CC-Tapis
Delsey
Eastpack
Gio Pastori
Interno 8

Marazzi
Mario Luca Giusti
Mario Pedrali
Mepra
Mohebban
Moleskine
Probeat
Society

Styling

Elena Caponi
Sissi Valassina



The mark of
responsible forestry

Look for FSC™ certified products

Cerca i prodotti certificati FSC™



Look for GREENGUARD certified products

Cerca i prodotti certificati GREENGUARD



Look for CATAS certified products

Cerca i prodotti certificati CATAS



Pesi, dimensioni e colori sono indicativi. Pedrali si riserva la facoltà di apportare modifiche o migliorie senza alcun preavviso.

Weights, measurements and colours are indicative. Pedrali reserves the right to modify or upgrade the products without prior notice.

Industrial property right | Diritto di proprietà industriale

I contenuti del presente catalogo, quali, a titolo esemplificativo, le opere, le immagini, le fotografie, i documenti, i disegni, le figure, i loghi ed ogni altro materiale, in qualsiasi formato, pubblicato sono protetti a livello mondiale dal diritto d'autore e da ogni altro diritto di proprietà intellettuale di PEDRALI.

The contents of the present catalogue such as, by way of example, the works, the images, the pictures, the documents, the drawings, the forms, the logos and all other materials, published in any format, are worldwide protected by copyrights and any other industrial intellectual property right of Pedrali.