

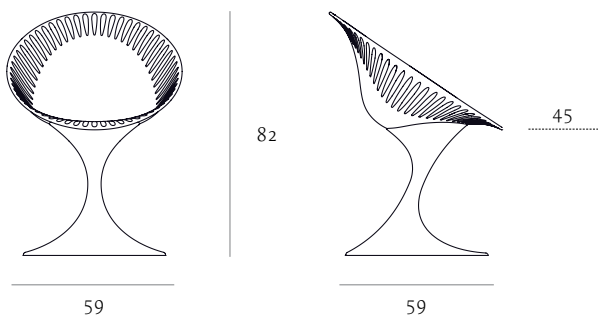

# ( AZHAR ) :



## AZHAR



## ABOUT

DESIGN: MARCELLO ZILIANI

Poltroncina con scocca stampata a iniezione ad alto spessore in poliammide lucido coprente o in policarbonato trasparente. Base in fusione di alluminio verniciato o in tondo d'acciaio cromato, anche in versione impilabile.

Disponibili cuscini in tessuto per sedile o sedile e schienale.

## AZHAR WIRE

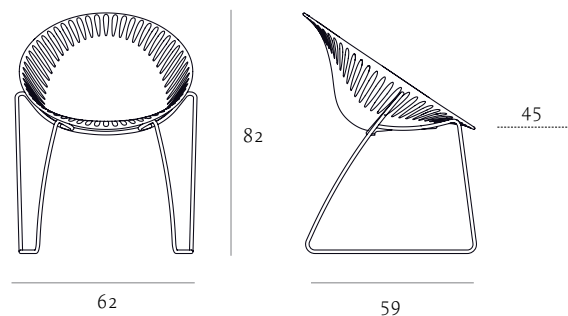

*Armchair with shell made of high thickness injection moulded polyamide full shiny colour or in transparent polycarbonate. Base in cast aluminum painted or chrome-plated round steel, available a stackable variant. Option: fabric cushions for the seat and/or back.*

## AZHAR 2012

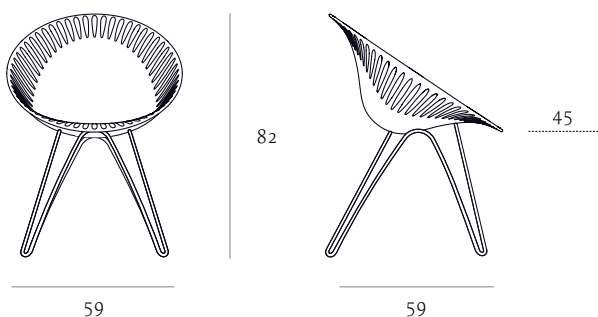

COLOURS

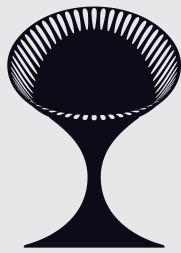

Nero 9004  
*Black 9004*



Bianco 9010  
*White 9010*

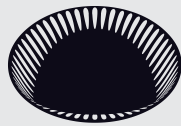

Nero 9004  
*Black 9004*



Rosso 3002  
*Red 3002*

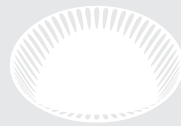

Bianco 9010  
*White 9010*

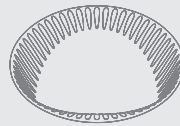

Trasparente  
*Transparent*

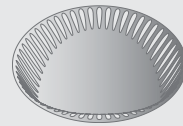

Trasparente Fumè  
*Transparent Fumè*

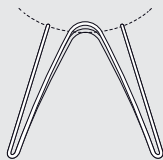

Laccato Bianco 9010/  
Nero 9004  
Cromato  
*Lacquered White 9010/  
Black 9004  
Chrome*

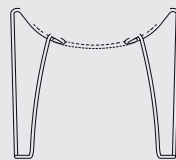

Laccato Bianco 9010/  
Nero 9004  
Cromato  
*Lacquered White 9010/  
Black 9004  
Chrome*