

NOVAMOBILI



Details
collection

NOVAMOBILI

Details
collection

Indice

Contents

Tavoli **Tables** p. 4

Hanami
p. 6

Torii
p. 14

Level
p. 22

Stretch
p. 30

Sunny
p. 38

Filo
p. 46

Argos
p. 54

Sedie **Seating** p. 60

Rose
p. 62

Twist
p. 70

Navy, Navy Tub
p. 78

Natt
p. 86

Candy
p. 92

Time
p. 98

Church
p. 104

Madie **Sideboards** p. 108

Belt
p. 110

Cleo
p. 120

Float
p. 126

Rim
p. 132

Shadows
p. 140

Stripe
p. 146

Reverse
p. 154

Tavolini **Occasional tables** p. 160

Fly
p. 162

Cliff
p. 168

Kin
p. 172

Orbis
p. 176

Globe
p. 180

Team
p. 186

Trio
p. 190

Circle
p. 194

Seven
p. 198

Shadows
p. 202

Allout
p. 206

Accessori **Accessories** p. 210

Freebook
p. 212

Odette
p. 216

Deep
p. 220

Riga
p. 224

Cube
p. 232

Ninfea
p. 238

Finiture e materiali **Finishes and materials** p. 244

Indice prodotti **Product index** p. 250

Tavoli

Tables



Hanami

— Design by Matteo Zorzenoni



Linee fluide e attenzione ai dettagli caratterizzano il tavolo Hanami. Le gambe inclinate e rastremate gli conferiscono dinamismo e leggerezza: un lavoro di ebanisteria che ne rivela l'alta qualità produttiva. Il piano è disponibile in marmo e pietra lavica, oppure nelle finiture noce canaletto, rovere chiaro, rovere carbone e in tutti i colori laccati opachi. Le gambe in finitura noce canaletto, rovere chiaro e carbone.

Flowing lines and attention to detail are the distinguishing features of the Hanami table. The angled, tapering legs produce a light, dynamic look: cabinet-making expertise has been applied to produce a piece of the highest quality. The top is available in marble and lava stone, or in the noce canaletto, rovere chiaro and rovere carbone finishes and any of the matt lacquered colour options. Legs can be in the noce canaletto, rovere chiaro or rovere carbone finish.





^{IT} Tavolo **Hanami** con gambe in finitura noce canaletto e piano in marmo grigio Oriente opaco, sedie **Rose** con struttura in finitura noce canaletto, seduta e schienale imbottiti in tessuto Levante 06. Libreria **Pontile** con montanti in alluminio brunito, ripiani e listelli frontali in laccato ossidato brunito. Madia composta da basi **Box 18** in laccato opaco foresta e contenitori **Outline** con scocca e schiena in finitura noce e telaio in laccato opaco foresta, in appoggio su panca sp. 5 cm nella stessa finitura.

^{EN} **Hanami** table with legs in noce canaletto finish and matt grigio Oriente marble top, **Rose** chairs with frame in noce canaletto finish, padded seat and back in Levante 06 fabric. **Pontile** bookcase with bronze-finish aluminium uprights, shelves and front strips in oxidized bronze lacquered finish. Sideboard comprising **Box 18** base units in foresta matt lacquered finish and **Outline** storage units with carcass and back panel in noce finish with foresta matt lacquered frame, sitting on 5cm-thick bench in the same finish.

IT Tavolo Hanami in finitura rovere chiaro e sedie Twist con struttura nella stessa finitura, seduta e schienale in tessuto Hive 54. Contenitori sospesi Outline in laccato opaco marino. Madia sospesa composta da basi Box 18 in finitura argilla pomice. Poltrona Origin in tessuto Rice 40 e 11.

EN Hanami table in rovere chiaro finish and Twist chairs with frame in the same finish, seat and back in Hive 54 fabric. Outline wall units in marino matt lacquered finish. Wall-mounted sideboard comprising Box 18 base units in pomice clay finish. Origin armchair in Rice 40 and 11 fabrics.



TECHNICAL DATA

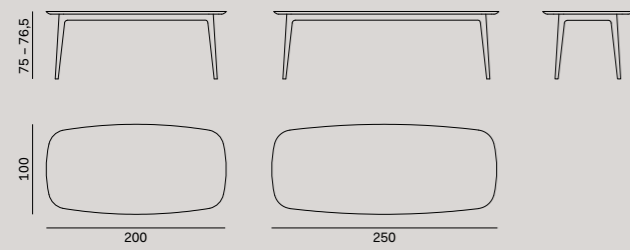

SET INSPIRATION

^{IT} Tavolo Hanami con gambe in finitura rovere carbone e piano in laccato opaco quarzo, sedie Candy con struttura in finitura rovere carbone e seduta in tessuto Milton 11. Libreria Wall 30 in laccato opaco magnolia.

^{EN} Hanami table with legs in rovere carbone finish and quarzo matt lacquered top, Candy chairs with frame in rovere carbone finish and seat in Milton 11 fabric. Wall 30 bookcase in magnolia matt lacquered finish.



CLOSE-UP

— 1
Variante del tavolo con gambe e piano in finitura rovere carbone. / Table version with legs and top in rovere carbone finish.

— 2
Variante del tavolo con gambe in finitura rovere chiaro e piano in marmo bianco di Carrara opaco. / Table version with legs in rovere chiaro finish and top in matt bianco Carrara marble.

— 3
Variante del tavolo con gambe in finitura noce canaletto e piano in laccato opaco fango. / Table version with legs in noce canaletto finish and top in fango matt lacquered finish.



Torii

— Design by Matteo Zorzenoni



Ispirato agli antichi portali d'accesso dei templi giapponesi, il tavolo Torii è costituito da una struttura con elemento centrale a forma di T rovesciata, che si unisce morbidamente al piano. Presentato in eleganti abbinamenti materico-cromatici, il piano può essere in marmo o pietra lavica, in finitura rovere carbone o noce canaletto, o ancora in tutti i colori laccati opachi; le gambe in finitura rovere carbone e noce canaletto.

Inspired by ancient Japanese temple gateways, the Torii table comprises a frame featuring a central element in an inverted T shape that connects gently with the top. Presented in elegant material and colour combinations, its top can be in marble or lava stone, in either the rovere carbone or noce canaletto finish, or any of the matt lacquered colours, while the legs come in rovere carbone and noce canaletto finishes.





^{IT} Tavolo **Torii** in finitura rovere carbone e sedie **Navy** con struttura nella stessa finitura e seduta in tessuto Mood 05. Madia sospesa composta da basi **Box 18** in finitura rovere carbone, vassoio credenza e base **Box 18** in laccato opaco blu notte.

^{EN} **Torii** table in rovere carbone finish and **Navy** chairs with frame in the same finish and seat in Mood 05 fabric. Wall-mounted sideboard comprising **Box 18** base units in rovere carbone finish, sideboard tray and **Box 18** base unit in blu notte matt lacquered finish.

IT Tavolo **Torii** con gambe in finitura noce canaletto e piano in marmo grigio Oriente opaco, sedie **Time** e pouf **Loto** in ecopelle Slim 20. **Madia Float** in laccato ossidato peltro con basamento in laccato ossidato brunito.

EN **Torii** table with legs in noce canaletto finish and matt grigio Oriente marble top, **Time** chairs and **Loto** ottoman in Slim 20 imitation leather. **Float** sideboard in oxidized pewter lacquered finish with oxidized bronze lacquered base.



TECHNICAL DATA

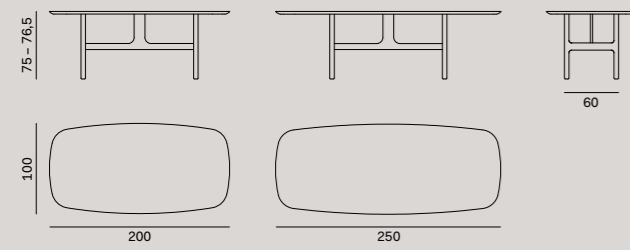

SET INSPIRATION

^{IT} Tavolo Torii con gambe in finitura noce canaletto e piano in laccato opaco ginepro, sedie Twist con struttura in finitura noce canaletto, seduta e schienale in tessuto Levante 28. Pensili Box 18 in laccato opaco grigio, ante Era in vetro cannettato con telaio in laccato opaco grigio.

^{EN} Torii table with legs in noce canaletto finish and ginepro matt lacquered top, Twist chairs with frame in noce canaletto finish, seat and back in Levante 28 fabric. Box 18 wall units in grigio matt lacquered finish, Era reeded glass doors with grigio matt lacquered frame.



CLOSE-UP

— 1 Variante del tavolo con gambe in finitura rovere carbone e piano in pietra lavica opaca. / Table version with legs in rovere carbone finish and matt lava stone top.

— 2 Variante del tavolo con gambe e piano in finitura noce canaletto. / Table version with legs and top in noce canaletto finish.

— 3 Variante del tavolo con gambe in finitura rovere carbone e piano in laccato opaco visone. / Table version with legs in rovere carbone finish and top in visone matt lacquered finish.

Level

— Design by Matteo Zorzenoni



Level è un tavolo caratterizzato dalle linee morbide della struttura, che sostiene un piano sottile dagli angoli arrotondati. È allungabile fino a due metri e mezzo, per ospitare dieci commensali. Il tavolo è disponibile in finitura rovere miele e rovere terra.

Level is a table characterized by the soft lines of its frame, which supports a slim top with rounded corners. It extends up to an impressive two-and-a-half metres, seating up to ten. The table is available in the rovere miele and rovere terra finishes.





^{IT} Tavolo Level in finitura rovere miele, sedie Natt con struttura nella stessa finitura e seduta in tessuto Milton 17, pouf Tamburello in tessuto Hive 21. Libreria Pontile con montanti in alluminio brunito, ripiani e listelli frontali in laccato opaco piombo.

^{EN} Level table in rovere miele finish, Natt chairs with frame in the same finish and seat in Milton 17 fabric, Tamburello ottoman in Hive 21 fabric. Pontile bookcase with bronze-finish aluminium uprights, shelves and front strips in piombo matt lacquered finish.



IT Tavolo Level in finitura rovere terra, sedie Navy con struttura nella stessa finitura e seduta in tessuto Pure 24, pouf Tamburello in tessuto Hive 21. Madia Rim in laccato opaco e lucido ginepro con basamento H 15 cm in laccato ossidato brunito.

EN Level table in rovere terra finish, Navy chairs with frame in the same finish and seat in Pure 24 fabric, Tamburello ottomans in Hive 21 fabric. Rim sideboard in ginepro matt and gloss lacquered finishes with oxidized bronze lacquered base H 15 cm.



TECHNICAL DATA

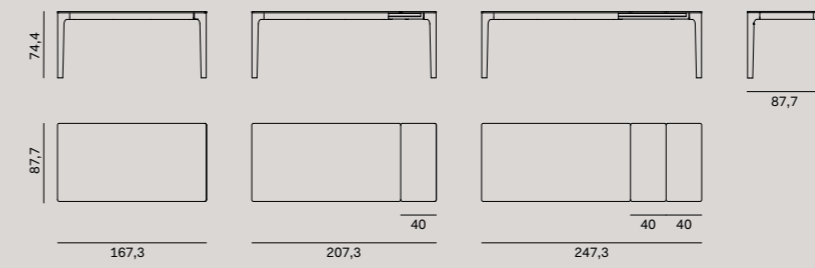

CLOSE-UP

– 1
Variante del tavolo in finitura rovere miele. / Table version in rovere miele finish.

– 2
Variante del tavolo in finitura rovere terra. / Table version in rovere terra finish.

Stretch

— Design by Zaven



Stretch è un tavolo allungabile dall'aspetto solido e contemporaneo. È costituito da elementi essenziali, combinati tra loro in modo originale: la cornice che sorregge il top accoglie anche le gambe, posizionate agli angoli per dare vita a un disegno caratterizzante. Il tavolo, in finitura rovere carbone o noce canaletto, è pensato per gli ambienti domestici e le occasioni conviviali: allungabile fino a tre metri, può ospitare dodici persone.

Stretch is a solid and contemporary looking extending table. It is the sum of pared-back elements put together in an original way: the frame supporting the top also accommodates the legs, which are set at an angle to produce a distinctive design. The table, in the rovere carbone or noce canaletto finish, has been designed for entertaining at home: it extends up to an impressive three metres, seating up to twelve people.



^{IT} Tavolo Stretch in finitura noce canaletto, sedie Rose con struttura nella stessa finitura, seduta e schienale imbottiti in tessuto Levante 06. Madia Stripe in laccato opaco piombo con top in finitura noce canaletto e basamento in laccato opaco piombo.

^{EN} Stretch table in noce canaletto finish, Rose chairs with frame in the same finish, padded seat and back in Levante 06 fabric. Stripe sideboard in piombo matt lacquered finish with top in noce canaletto finish and piombo matt lacquered base.

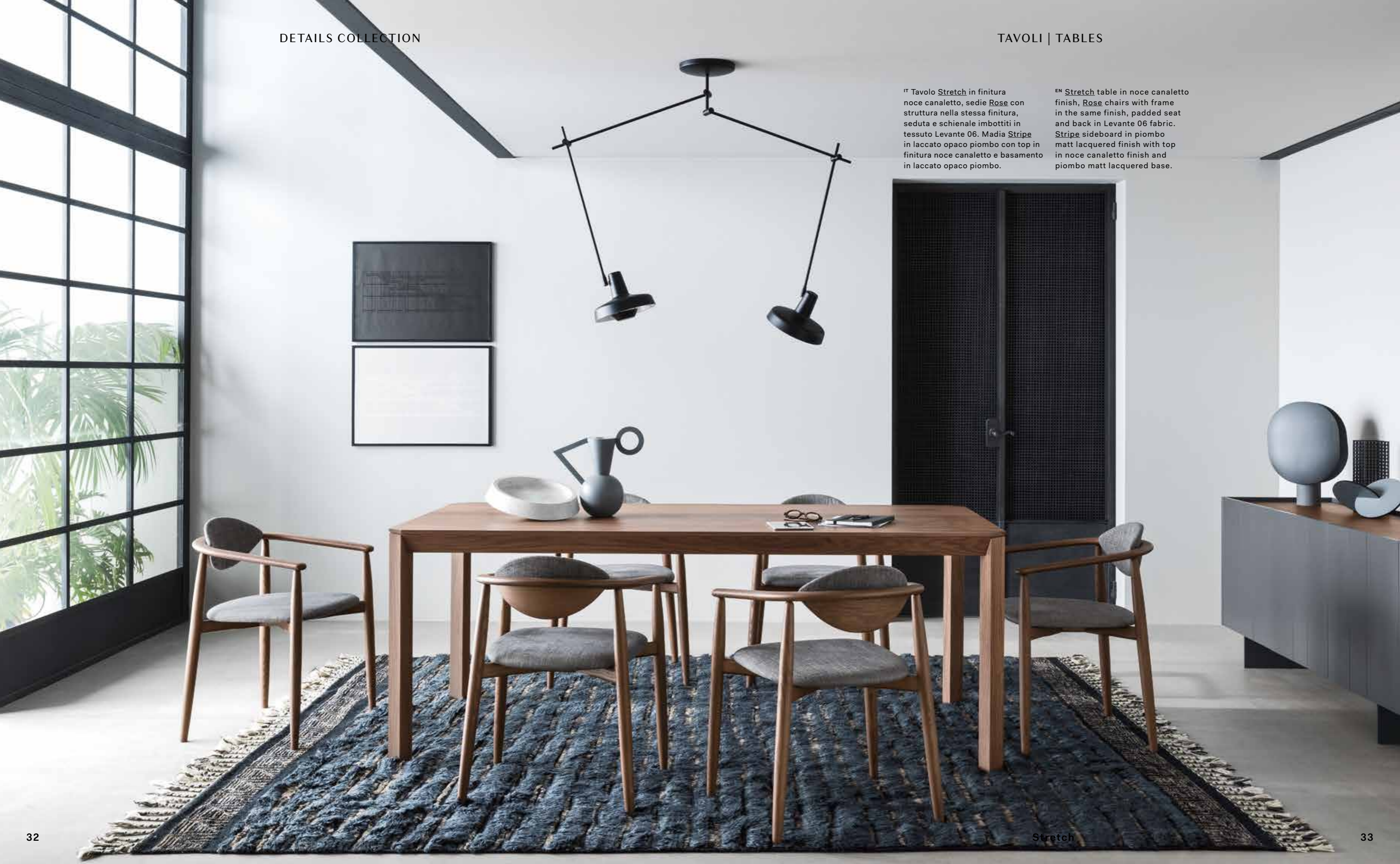



^{IT} Tavolo Stretch in finitura rovere carbone, sedie Time in tessuto Milton 28, pouf Loto in tessuto Mood 12 e in ecopelle Slim 20. Madia composta da basi Box 18 in finitura argilla pomice su basamento Tube in laccato ossidato brunito. Contenitori sospesi Outline con telaio in laccato ossidato brunito, scocca e schiena in finitura olmo termotrattato.

^{EN} Stretch table in rovere carbone finish, Time chairs in Milton 28 fabric, Loto ottomans in Mood 12 fabric and Slim 20 imitation leather. Sideboard comprising Box 18 base units in pomice clay finish on oxidized bronze lacquered Tube base. Outline wall units with oxidized bronze lacquered frame, carcass and back panel in olmo termotrattato finish.





TECHNICAL DATA

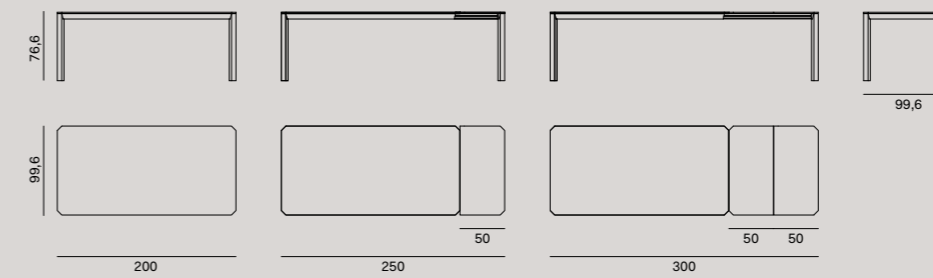

CLOSE-UP

— 1
Variante del tavolo, in finitura rovere carbone, aperto per essere allungato. / Table version in rovere carbone finish, opened for extending.

— 2
Il tavolo allungato con un'allunga. / The table extended with a single extension leaf.

— 3
Il tavolo allungato con due allunghe. / The table extended with two extension leaves.

Sunny

— Design by Zaven



Tre gambe metalliche, dal segno pulito e dinamico, sostengono il piano circolare di Sunny, tavolo essenziale dalle linee contemporanee. Il piano è disponibile in marmo e pietra lavica, oppure nelle finiture noce e olmo termotrattato, in laccato opaco e ossidato, o ancora in light stone, un materiale ceramico a pasta dura impermeabile e resistente. Il basamento nei colori laccati opachi, ossidati o metal, per combinazioni dall'effetto prezioso.

Three metal legs, with a clean, dynamic design, support the circular top on Sunny, a contemporary style pared-back table. The top comes in marble or lava stone, or in the noce and olmo termotrattato finishes, matt and oxidized lacquered finishes, or in the light stone option: a strong, impermeable hard-paste ceramic material. The base in a choice of matt, oxidized or metal lacquered colours makes for luxe-feeling combinations.



IT Tavolo **Sunny** con gambe in laccato metal ottone e piano in light stone bianco, sedie **Twist** con struttura in finitura rovere terra, seduta e schienale in tessuto Memory 05. Madia **Cleo** in finitura rovere terra con maniglia e basamento in laccato metal ottone. Pouf **Loto** in tessuto Memory 05. Tavolino **Circle** in laccato ossidato brunito.

EN **Sunny** table with legs in brass metal lacquered finish and bianco light stone top, **Twist** chairs with frame in rovere terra finish, seat and back in Memory 05 fabric. **Cleo** sideboard in rovere terra finish with handle and base in brass metal lacquered finish. **Loto** ottoman in Memory 05 fabric. **Circle** occasional table in oxidized bronze lacquered finish.

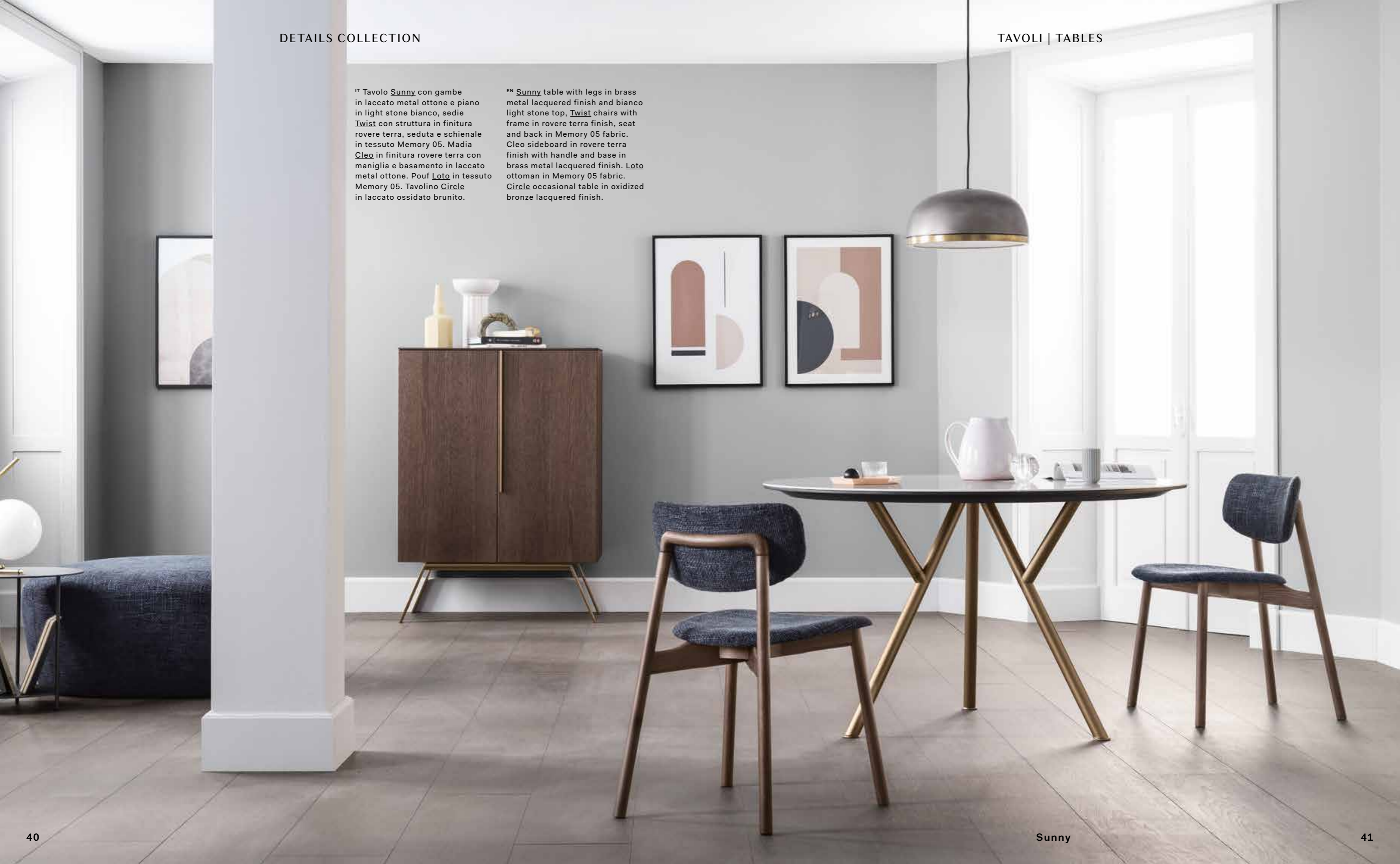



^{IT} Tavolo **Sunny** con gambe in laccato ossidato brunito e piano in finitura olmo termotrattato, sedie **Time** in tessuto **Coco 28**, pouf **Loto** in tessuto **Mood 12**. Madie composte da basi **Box 18** in laccato lucido blu notte e contenitori **Tetris** in finitura rovere carbone su basamento **Double** in laccato ossidato brunito.

^{EN} **Sunny** table with oxidized bronze lacquered legs and top in olmo termotrattato finish, **Time** chairs in **Coco 28** fabric, **Loto** ottoman in **Mood 12** fabric. Sideboards comprising blu notte gloss lacquered **Box 18** base units and **Tetris** storage units in rovere carbone finish on **Double** base in oxidized bronze lacquered finish.



TECHNICAL DATA

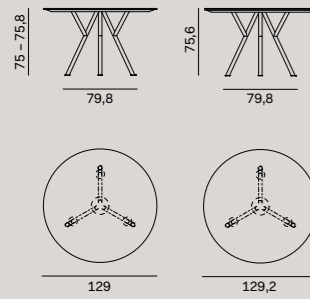

CLOSE-UP

— 1
Variante del tavolo con gambe in laccato opaco ginepro e piano in marmo verde Guatemala opaco. / *Table version with ginepro matt lacquered legs and matt verde Guatemala marble top.*

— 2
Variante del tavolo con gambe e piano in laccato opaco blu notte. / *Table version with legs and top in blu notte matt lacquered finish.*

— 3
Variante del tavolo con gambe in laccato opaco quarzo e piano in finitura noce. / *Table version with quarzo matt lacquered legs and top in noce finish.*

SET INSPIRATION

^{IT} Tavolo Sunny con gambe in laccato opaco nero grafite e piano in pietra lavica nera opaca, sedie Rose con struttura in laccato opaco nero grafite e seduta in paglia intrecciata color grafite, pouf Tamburello in tessuto Memory 45. Pensili Box 18 in finitura rovere carbone e contenitori Tetris in appoggio in laccato opaco artico. Mensole Ellie in laccato ossidato brunito. Specchio Deep in laccato ossidato brunito con luce LED integrata.

^{EN} Sunny table with nero grafite matt lacquered legs and matt black lava stone top, Rose chairs with nero grafite matt lacquered frame and handwoven straw seat in graphite finish, Tamburello ottoman in Memory 45 fabric. Box 18 wall units in rovere carbone finish and Tetris units sitting on top in artico matt lacquered finish. Ellie shelves in oxidized bronze lacquered finish. Deep mirror in oxidized bronze lacquered finish with built-in LED lighting.



Filo

— Design by Novamobili studio



Un design minimale e una struttura leggera contraddistinguono il tavolo Filo, disponibile in versione quadrata o rettangolare. Le linee essenziali e le numerose possibilità di personalizzazione ne fanno un tavolo versatile, che si adatta ai più diversi contesti. Il tavolo è disponibile in tutti i colori laccati opachi, ossidati e metal. Per un effetto più prezioso, al piano si può applicare un top in light stone o, nella versione rettangolare, anche nelle finiture noce e olmo termotrattato.

Minimal design and a light frame give the Filo table – available in a square and rectangular version – its distinctive look. Pared-back lines and a wealth of custom options make this a versatile table that works well in all manner of settings. The table comes in any of the matt, oxidized and metal lacquered colour options. For an even more luxe feel, a light stone top can be applied, while the rectangular version also comes in the noce and olmo termotrattato finishes.





^{IT} Tavolo **Filo** quadrato con struttura in laccato opaco nero grafite e piano sp. 0,6 cm in light stone nero, sedie **Rose** con struttura in finitura rovere carbone e seduta in ecopelle Slim 11. Madia composta da basi **Box 18** in finitura rovere carbone, vassoio credenza e base **Box 18** in laccato opaco blu notte.

^{EN} Square **Filo** table with nero grafite matt lacquered frame and 0,6cm-thick nero light stone top, **Rose** chairs with frame in rovere carbone finish and seat in Slim 11 imitation leather. Sideboard comprising **Box 18** base units in rovere carbone finish, sideboard tray and **Box 18** base unit in blu notte matt lacquered finish.



^{IT} Tavolo *Filo* rettangolare con struttura in laccato opaco quarzo e piano sp. 1,2 cm in finitura noce, sedia *Navy Tub* con struttura in finitura rovere terra e seduta in ecopelle Slim 20. Libreria *Wall 12* in laccato opaco ginepro. Pouf *Loto* in ecopelle Slim 20.

^{EN} Rectangular *Filo* table with quarzo matt lacquered frame and 1,2cm-thick top in noce finish, *Navy Tub* chair with frame in rovere terra finish and seat in Slim 20 imitation leather. *Wall 12* bookcase in ginepro matt lacquered finish. *Loto* ottoman in Slim 20 imitation leather.

TECHNICAL DATA

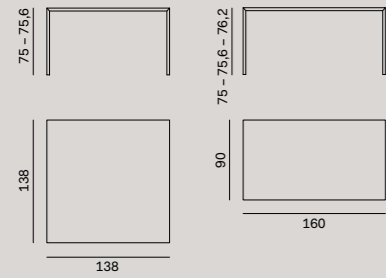

SET INSPIRATION

IT Tavolo Filo in laccato opaco sandalo e sedie Time in tessuto Milton 11. Madia sospesa composta da basi Box 18 con ante Era in lamiera traforata e contenitori Outline in appoggio, tutto in laccato ossidato peltro. Specchi Deep in laccato ossidato brunito.

EN Filo table in sandalo matt lacquered finish and Time chairs in Milton 11 fabric. Wall-mounted sideboard comprising Box 18 base units with Era perforated sheet metal doors and Outline storage units sitting on top, all in oxidized pewter lacquered finish. Deep mirrors in oxidized bronze lacquered finish.



1



2



3

CLOSE-UP

— 1 Variante del tavolo con struttura in laccato opaco bianco e piano sp. 0,6 cm in light stone bianco. / Table version with bianco matt lacquered frame and 0,6cm-thick top in bianco light stone.

— 2 Variante del tavolo con struttura in laccato ossidato bronzo e piano sp. 1,2 cm in finitura olmo termotrattato. / Table version with oxidized light bronze lacquered frame and 1,2cm-thick top in olmo termotrattato finish.

— 3 Variante del tavolo in laccato opaco foresta. / Table version in foresta matt lacquered finish.

Argos

— Design by Studio Gherardi



Il tavolo Argos nasce dal perfetto equilibrio tra geometria, solidità e leggerezza formale. Ovale o rotondo, il piano è disponibile nelle finiture noce e olmo termotrattato, e in tutti i colori laccati opachi e ossidati. Le gambe possono essere in finitura noce o olmo termotrattato e in tutti i colori laccati opachi.

The Argos table is the product of a perfect balance between geometry, solidity and lightness of form. Oval or round, the top comes in the noce and olmo termotrattato finishes, and in any of the matt or oxidized lacquered colours. Legs come in a choice of noce or olmo termotrattato finishes, or in any of the matt lacquered colours.





^{IT} Tavolo **Argos** rotondo in laccato opaco tiglio, sedie **Navy Tub** con struttura in finitura rovere miele e seduta in tessuto Memory 12, pouf **Loto** in tessuto Memory 45. **Madia Belt** in laccato opaco foglia con ante **Era** in vetro trasparente e telaio in laccato opaco foglia, interni in finitura rovere miele e basamento in laccato ossidato brunito.

^{EN} Round **Argos** table in tiglio matt lacquered finish, **Navy Tub** chairs with frame in rovere miele finish and seat in Memory 12 fabric, **Loto** ottoman in Memory 45 fabric. **Belt** sideboard in foglia matt lacquered finish with **Era** transparent glass doors featuring foglia matt lacquered frame, interior in rovere miele finish and oxidized bronze lacquered base.



^{IT} Tavolo **Argos** ovale in finitura olmo termotrattato, sedie **Candy** con struttura in finitura rovere carbone e seduta in tessuto Milton 11 e 42. **Madia Reverse** in laccato opaco sandalo con vano a giorno in finitura olmo termotrattato e basamento in laccato ossidato brunito.

^{EN} Oval **Argos** table in olmo termotrattato finish, **Candy** chairs with frame in rovere carbone finish and seat in Milton 11 and 42 fabrics. **Reverse** sideboard in sandalo matt lacquered finish with open shelving in olmo termotrattato finish and oxidized bronze lacquered base.

TECHNICAL DATA

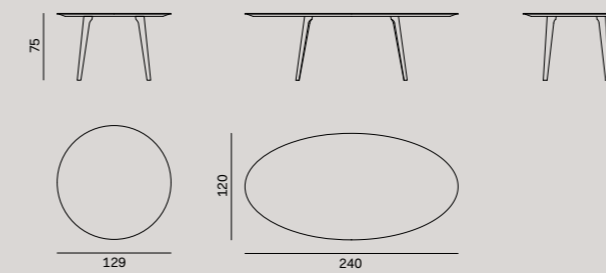

CLOSE-UP

Dettaglio del piano in finitura olmo termotrattato. / Detail of the top in olmo termotrattato finish.

Sedie

Seating



Rose

— Design by Zanellato/Bortotto



Rose è una sedia dalle linee morbide, frutto di un lavoro in gran parte artigianale: ogni elemento in legno viene rifinito a mano, così come la seduta. La struttura si può scegliere in finitura rovere chiaro, rovere miele, rovere terra, rovere carbone, noce canaletto e in tutti i colori laccati opachi. La seduta può essere imbottita in tessuto o ecopelle, oppure in paglia intrecciata color grafite. Rose è disponibile anche con schienale imbottito.

With its soft lines, the Rose chair has been crafted in large part using old-fashioned workmanship: each wooden element is finished by hand, as is the seat. The frame comes in a choice of rovere chiaro, rovere miele, rovere terra, rovere carbone and noce canaletto finishes and any of the matt lacquered colours. The seat can be upholstered in fabric or imitation leather, or can be made from handwoven straw in graphite finish. Rose also comes with the option of a padded back.





IT Sedie Rose con struttura in finitura noce canaletto, seduta e schienale imbottiti in tessuto Levante 06. Tavolo Hanami con gambe in finitura noce canaletto e piano in marmo grigio Oriente opaco. Madia composta da basi Box 18 in laccato opaco foresta, contenitori Outline con scocca e schiena in finitura noce e telaio in laccato opaco foresta, in appoggio su panca sp. 5 cm nella stessa finitura.

EN Rose chairs with frame in noce canaletto finish, padded seat and back in Levante 06 fabric. Hanami table with legs in noce canaletto finish and matt grigio Oriente marble top. Sideboard comprising Box 18 base units in foresta matt lacquered finish, Outline storage units with carcass and back panel in noce finish with foresta matt lacquered frame, sitting on 5cm-thick bench in the same finish.





^{IT} Sedie *Rose* con struttura in finitura rovere chiaro e seduta in tessuto Mood 11. Tavolo *Hanami* in finitura rovere chiaro.

^{EN} *Rose* chairs with frame in rovere chiaro finish and seat in Mood 11 fabric. *Hanami* table in rovere chiaro finish.



TECHNICAL DATA

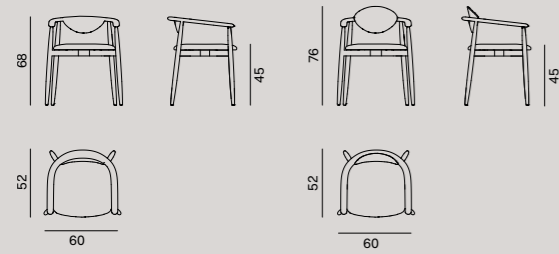

FOCUS

IT Sedie Rose, da sinistra: con struttura in laccato opaco corda e seduta e schienale imbottiti in tessuto Storm 12; con struttura in finitura rovere miele e seduta in tessuto Opera 18; con struttura in finitura noce canaletto e seduta in tessuto Memory 13; con struttura in finitura rovere terra e seduta in tessuto Hive 15.

EN Rose chairs, from left: with corda matt lacquered frame and padded seat and back in Storm 12 fabric; with frame in rovere miele finish and seat in Opera 18 fabric; with frame in noce canaletto finish and seat in Memory 13 fabric; with frame in rovere terra finish and seat in Hive 15 fabric.



CLOSE-UP

Dettaglio della sedia con struttura in finitura noce canaletto e seduta in paglia intrecciata a mano color grafite. / Detail of chair with frame in noce canaletto finish and graphite-coloured handwoven straw seat.



Twist

— Design by Matteo Zorzenoni



Sedia che reinterpreta le forme degli anni Sessanta, Twist è resa dinamica dalla particolare inclinazione delle gambe posteriori, che si estendono e si uniscono a sostenere lo schienale. La struttura è disponibile in finitura rovere chiaro, rovere miele, rovere terra, rovere carbone o noce canaletto; seduta e schienale imbottiti in ecopelle e in tutti i tessuti a catalogo.

A contemporary take on Sixties shapes, the Twist chair draws its dynamic look from the unusually angled legs to the rear, which climb up and join together to support the backrest. The frame comes in the rovere chiaro, rovere miele, rovere terra, rovere carbone or noce canaletto finishes; the padded seat and backrest come in imitation leather and any of the fabrics from the catalogue.



^{IT} Sedie Twist con struttura in finitura rovere chiaro, seduta e schienale in tessuto Hive 54. Tavolo Argos rotondo in laccato opaco tiglio. Madia Rim in laccato opaco e lucido ginepro su basamento H 15 cm in laccato ossidato brunito.

^{EN} Twist chairs with frame in rovere chiaro finish, seat and back in Hive 54 fabric. Round Argos table in tiglio matt lacquered finish. Rim sideboard in ginepro matt and gloss lacquered finishes on oxidized bronze lacquered base H 15 cm.



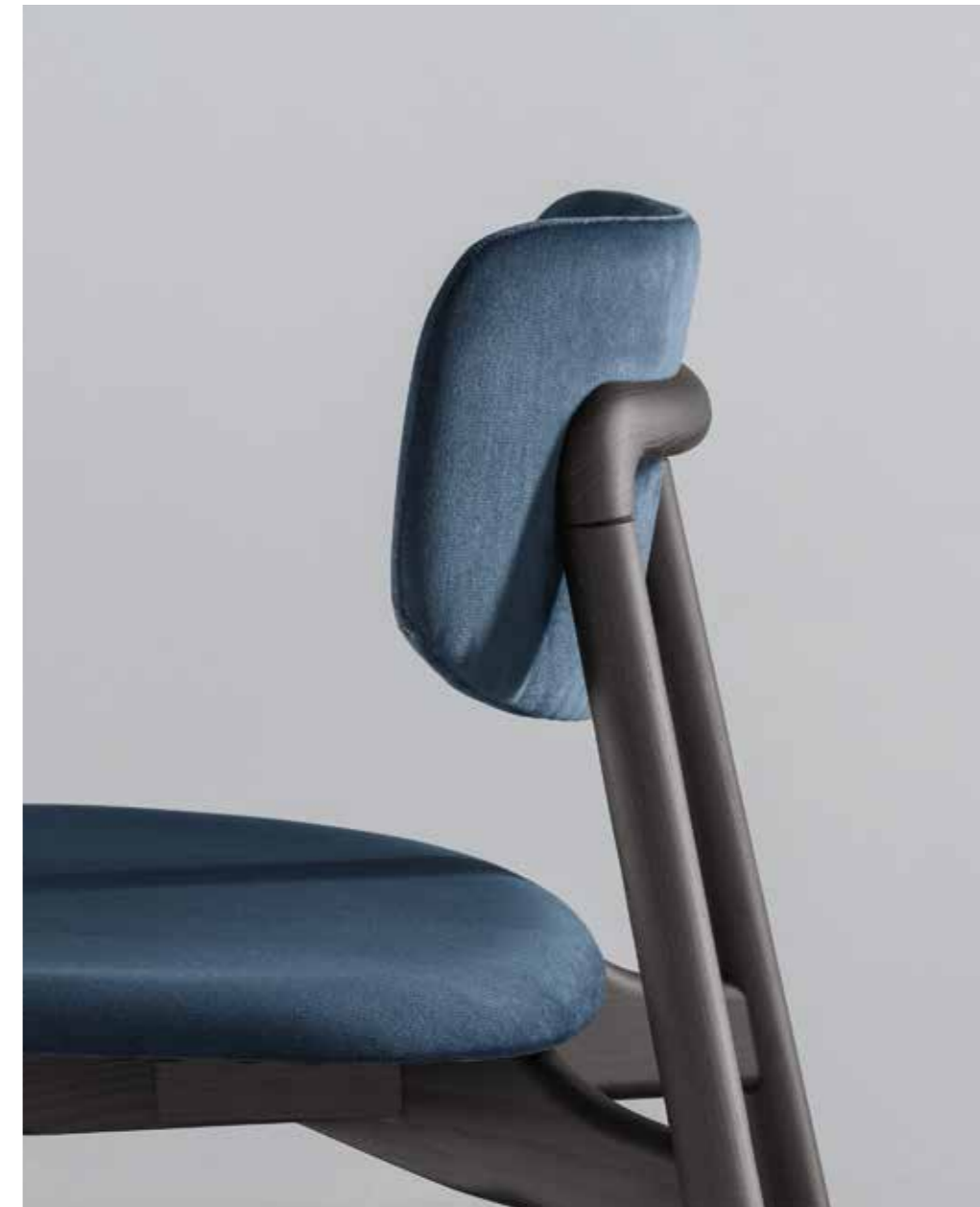

^{IT} Sedia *Twist* con struttura in finitura rovere carbone, seduta e schienale in tessuto Opera 18. Tavolo *Filo* con struttura in laccato opaco nero grafite e piano sp. 0,6 cm in light stone nero. Mensole *Ellie* in laccato ossidato brunito.

^{EN} *Twist* chair with frame in rovere carbone finish, seat and back in Opera 18 fabric. *Filo* table with frame in nero grafite matt lacquered finish and 0,6cm-thick nero light stone top. *Ellie* shelves in oxidized bronze lacquered finish.

TECHNICAL DATA

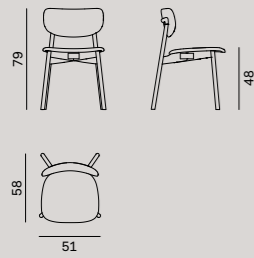

FOCUS

^{IT} Sedie Twist, da sinistra:
con struttura in finitura rovere
miele, seduta e schienale in
tessuto Milton 09; con struttura
in finitura rovere terra, seduta
e schienale in tessuto Hive 41;
con struttura in finitura noce
canaletto, seduta e schienale
in tessuto Memory 05.

^{EN} Twist chairs, from left: with
frame in rovere miele finish, seat
and back in Milton 09 fabric; with
frame in rovere terra finish, seat
and back in Hive 41 fabric; with
frame in noce canaletto finish,
seat and back in Memory 05 fabric.



Navy, Navy Tub

— Design by Matteo Zorzenoni



Le sedie Navy e Navy Tub sono state pensate per i diversi ambienti della casa.

Alla struttura solida – in finitura rovere chiaro, rovere miele, rovere terra, rovere carbone e noce canaletto – si unisce una seduta imbottita dalle linee morbide e dolci, ancora più avvolgenti nella versione Navy Tub. Il rivestimento si può scegliere in tessuto, ecopelle o pelle extra.

The Navy and Navy Tub chairs have been designed for use in different rooms throughout the home. The solid frame – in rovere chiaro, rovere miele, rovere terra, rovere carbone and noce canaletto finishes – is paired with a softly and gently curving padded seat, which is even more cocooning on the Navy Tub version. They can be upholstered in a choice of fabric, imitation leather or extra leather.





^{IT} Sedie Navy Tub con struttura in finitura rovere miele e seduta in tessuto Memory 12. Tavolo Sunny con gambe in laccato metal ottone e piano in light stone bianco.

^{EN} Navy Tub chairs with frame in rovere miele finish and seat in Memory 12 fabric. Sunny table with legs in brass metal lacquered finish and bianco light stone top.

DETAILS COLLECTION

IT Sedie Navy con struttura in finitura rovere carbone e seduta in tessuto Mood 05. Tavolo Torii in finitura rovere carbone. Madia sospesa composta da basi Box 18 in finitura rovere carbone, vassoio credenza e base Box 18 in laccato opaco blu notte.

EN Navy chairs with frame in rovere carbone finish and seat in Mood 05 fabric. Torii table in rovere carbone finish. Wall-mounted sideboard comprising Box 18 base units in rovere carbone finish, sideboard tray and Box 18 base unit in blu notte matt lacquered finish.



SEDIE | SEATING



TECHNICAL DATA

— Navy

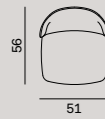
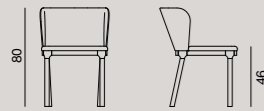

— Navy Tub

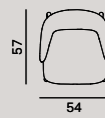
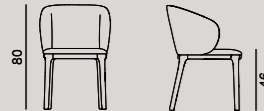

FOCUS

^{IT} Sedie Navy, da sinistra: con struttura in finitura rovere chiaro e seduta in tessuto Milton 11; con struttura in finitura rovere terra e seduta in tessuto Levante 08. Sedia Navy Tub con struttura in finitura rovere carbone e seduta in tessuto Storm 18.

^{EN} Navy chairs, from left: with frame in rovere chiaro finish and seat in Milton 11 fabric; with frame in rovere terra finish and seat in Levante 08 fabric. Navy Tub chair with frame in rovere carbone finish and seat in Storm 18 fabric.



Natt

— Design by Studio Gherardi



L'estetica nordica e l'ampia gamma di colori e tessuti con cui può essere realizzata rendono Natt una sedia perfetta per i diversi spazi della casa. La struttura è disponibile in finitura rovere chiaro, rovere miele, rovere terra e rovere carbone, oppure in tutti i colori laccati opachi; la seduta imbottita in tessuto sfoderabile o ecopelle.

With its Nordic look and wide range of colour and fabric options, Natt is a perfect chair for various spaces in the home. The frame comes in the rovere chiaro, rovere miele, rovere terra or rovere carbone finishes, or in any of the matt lacquered colours; the padded seat is covered with removable fabric or imitation leather.





^{IT} Sedia **Natt** con struttura in finitura rovere miele e seduta in tessuto Milton 17. Piano sp. 5 cm e basi **Box 18** in finitura rovere miele con vassoio tre lati in laccato opaco foresta. Specchio **Deep** in laccato ossidato bronzo.

^{EN} **Natt** chair with frame in rovere miele finish and seat in Milton 17 fabric. 5cm-thick top and **Box 18** base units in rovere miele finish with foresta matt lacquered 3-sided tray. **Deep** mirror in oxidized light bronze lacquered finish.

TECHNICAL DATA

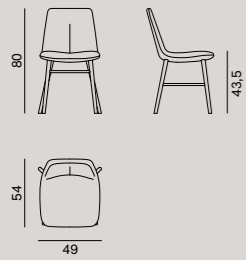

FOCUS

^{IT} Sedie **Natt**, da sinistra: con struttura in finitura rovere chiaro e seduta in tessuto Gravel 18; con struttura in finitura rovere carbone e seduta in tessuto Maia 10; con struttura in laccato opaco senape e seduta in tessuto Urban 32; con struttura in finitura rovere terra e seduta in tessuto Storm 47.

^{EN} **Natt** chairs, from left: with frame in rovere chiaro finish and seat in Gravel 18 fabric; with frame in rovere carbone finish and seat in Maia 10 fabric; with senape matt lacquered frame and seat in Urban 32 fabric; with frame in rovere terra finish and seat in Storm 47 fabric.



Candy

— Design by Novamobili studio



Comoda e versatile, Candy è una sedia imbottita dalle linee classiche e dalle infinite possibilità cromatiche. La struttura è disponibile in finitura rovere chiaro, rovere miele, rovere terra e rovere carbone, oppure in tutti i colori laccati opachi. La seduta imbottita in tessuto ed ecopelle.

Comfortable and versatile, Candy is a padded chair with classic lines and an infinite range of colours to choose from. The frame comes in the rovere chiaro, rovere miele, rovere terra or rovere carbone finishes, or in any of the matt lacquered colours. The padded seat is covered with fabric or imitation leather.





^{IT} Sedia Candy con struttura in finitura rovere carbone e seduta in tessuto Milton 11. Pouf Loto in ecopelle Slim 20. Libreria Pontile con montanti in alluminio brunito, ripiani e listelli frontali in laccato ossidato brunito.

^{EN} Candy chair with frame in rovere carbone finish and seat in Milton 11 fabric. Loto ottoman in Slim 20 imitation leather. Pontile bookcase with bronze-finish aluminium uprights, shelves and front strips in oxidized bronze lacquered finish.



TECHNICAL DATA

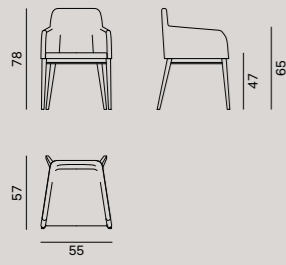

FOCUS

^{IT} Sedie Candy, da sinistra: con struttura in laccato opaco cenere e seduta in tessuto Hive 21; con struttura in finitura rovere chiaro e seduta in tessuto Memory 47; con struttura in finitura rovere terra e seduta in tessuto Milton 28; con struttura in finitura rovere miele e seduta in ecopelle Slim 20.

^{EN} Candy chairs, from left: with cenere matt lacquered frame and seat in Hive 21 fabric; with frame in rovere chiaro finish and seat in Memory 47 fabric; with frame in rovere terra finish and seat in Milton 28 fabric; with frame in rovere miele finish and seat in Slim 20 imitation leather.



Time

— Design by Studio Gherardi



Impilabile e sfoderabile, Time è una sedia dai contorni delicati. La struttura è completamente imbottita e rivestita in tessuto, ecopelle o pelle extra: una caratteristica che la rende interessante sia visivamente sia nel tocco, morbido e caldo.

Stackable and featuring removable upholstery, the Time chair features a dainty silhouette. The frame is padded and covered from head to toe with fabric, imitation leather or extra leather: a feature that provides both visual interest and a soft, warm tactile appeal.



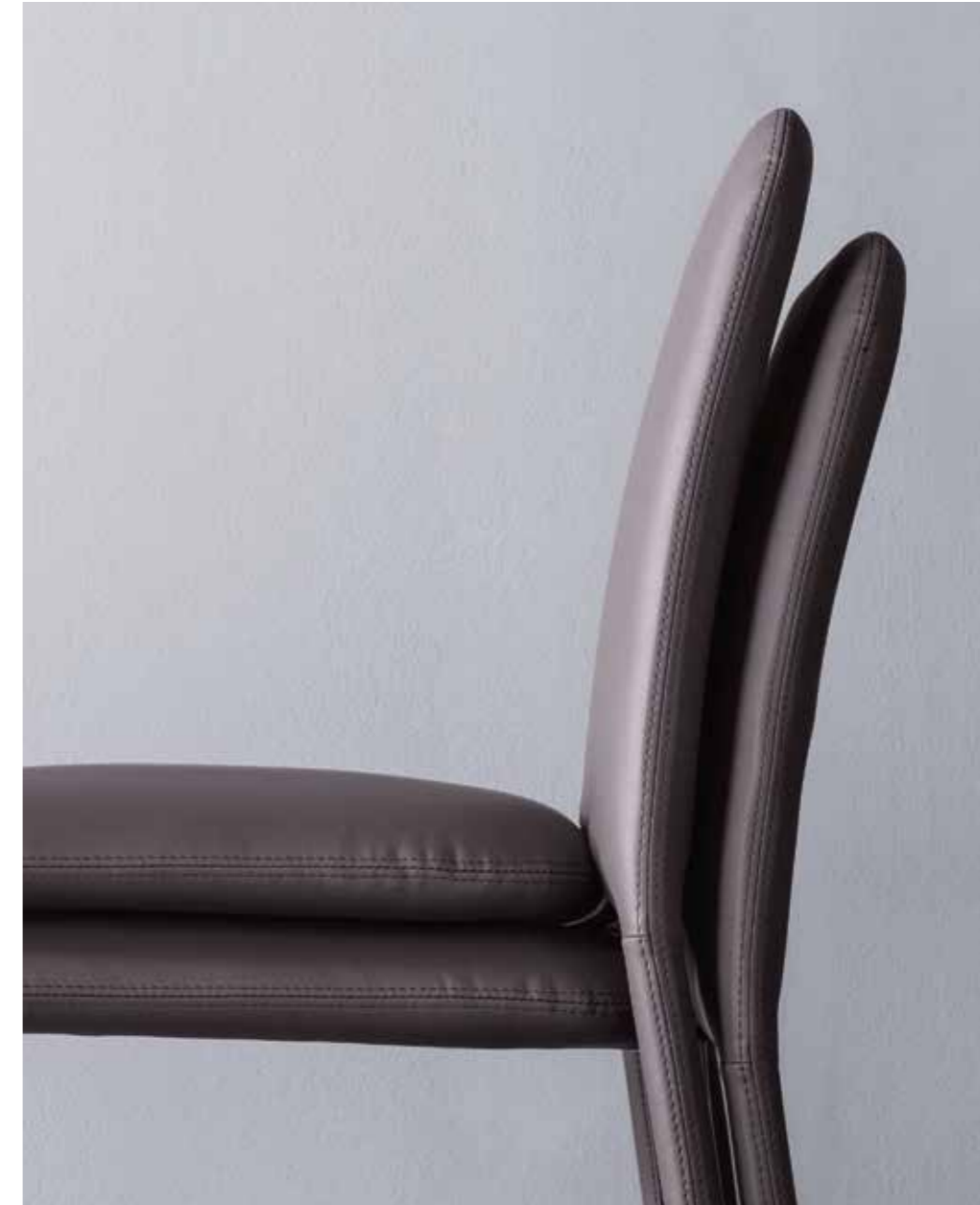

^{IT} Sedia **Time** in ecopelle Slim 20. Tavolo **Filo** in laccato opaco quarzo. Mensole **Ellie** in laccato ossidato brunito.

^{EN} **Time** chair in Slim 20 imitation leather. **Filo** table in quartz matt lacquered finish. **Ellie** shelves in oxidized bronze lacquered finish.

TECHNICAL DATA

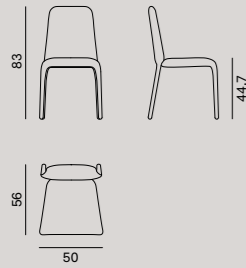

FOCUS

IT Sedie Time, da sinistra:
in tessuto Levante 28; in tessuto
Memory 23; in tessuto Mood 13.

EN Time chairs, from left:
in Levante 28 fabric; in Memory 23
fabric; in Mood 13 fabric.



Church

— Design by Studio Gherardi



Church è una panca imbottita adattabile a molteplici situazioni, dall'ingresso alla cabina armadio, e più in generale come complemento di ambienti dedicati al relax. La seduta, sfoderabile, è rivestita con tutti i tessuti e le ecopelli a catalogo. Il basamento è disponibile in tutti i colori laccati opachi, ossidati e metal.

Church is a padded bench that lends itself to a whole host of situations: from the entry hall to the walk-in wardrobe and, more generally speaking, as the perfect occasional piece in spaces made for unwinding. The seat has removable covers, which can be made from any of the fabric or imitation leather options in the catalogue. The base comes in any of the matt, oxidized and metal lacquered colour options.





TECHNICAL DATA

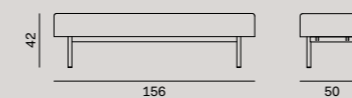

^{IT} Panca **Church** imbottita in tessuto Spin Decor 07 con gambe in laccato opaco corda. Mensola **Riga** in laccato opaco fango con specchio e appendiabiti in laccato opaco corda. Tavolino **Circle** in laccato ossidato brunito.

^{EN} **Church** bench upholstered in Spin Decor 07 fabric with legs in corda matt lacquered finish. **Riga** shelf in fango matt lacquered finish with corda matt lacquered mirror and coat hooks. **Circle** occasional table in oxidized bronze lacquered finish.

Madie

Sideboards



Belt

— Design by Philippe Nigro



Belt è una collezione di madie il cui punto di forza è la modularità. La madia, sospesa sul basamento in metallo in tutti i colori laccati opachi, ossidati e metal, presenta diverse configurazioni, ottenute dalla combinazione di ante e cassette per creare contenitori adatti a ogni ambiente della casa. I frontali sono disponibili in laccato opaco e ossidato oppure, nella versione Rays, anche in finitura noce canaletto. Con le ante in vetro Era, la madia si trasforma in un'elegante credenza che lascia intravedere l'interno ed è resa ancora più contemporanea dall'illuminazione a LED.

Belt is a collection of sideboards whose strength lies in its modular design. The sideboard – floating on the metal base in any of the matt, oxidized and metal lacquered colour options – comes in various configurations, achieved by combining doors and drawers to create storage units to suit any room in the home. The fronts are available in the matt and oxidized lacquered finishes, while the Rays version has the added option of noce canaletto finish. With the Era glass doors, the sideboard is transformed into an elegant display cabinet that lets the interior shine through, and is given an even more contemporary look by the LED lighting.

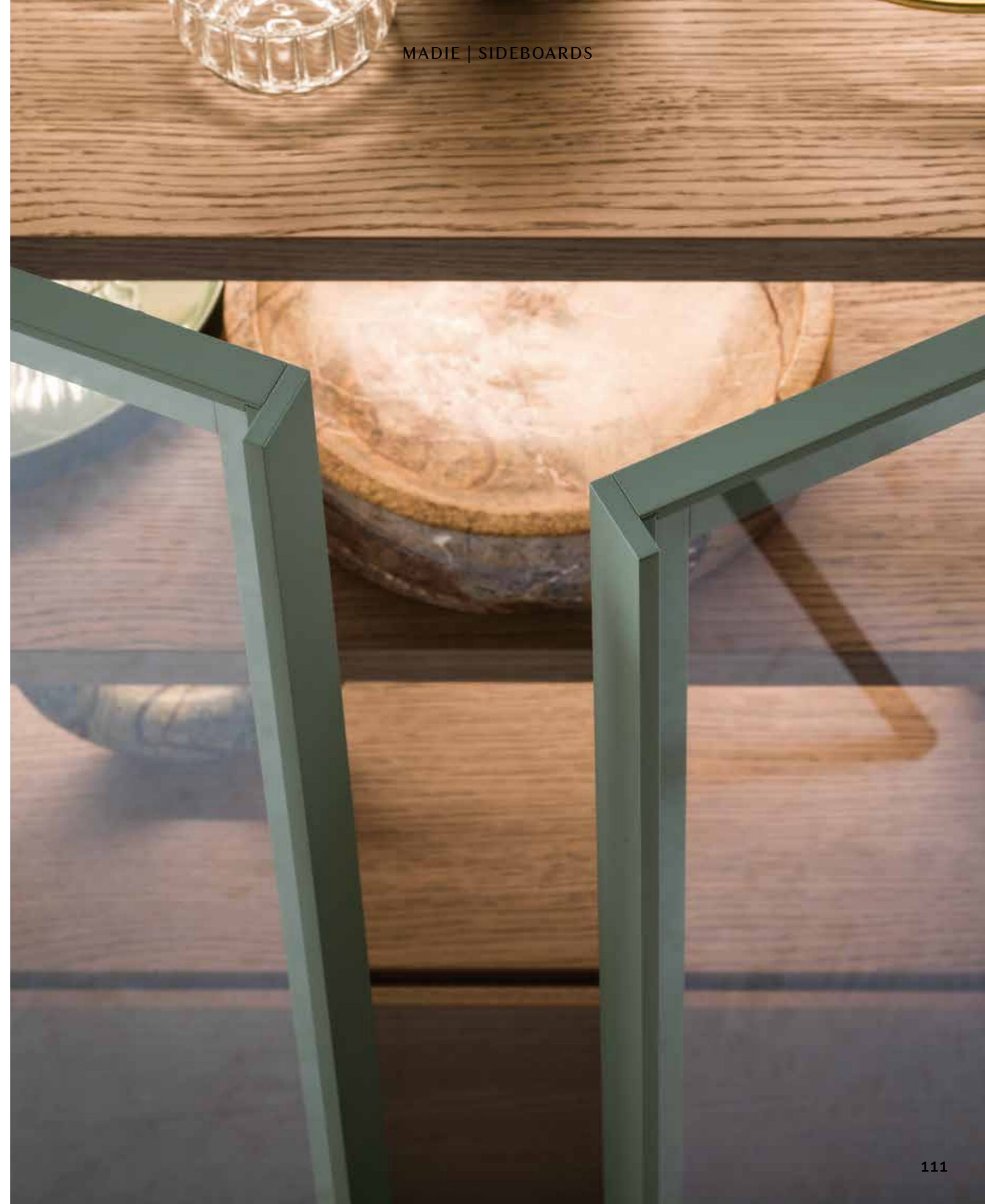



^{IT} **Madia Belt** in laccato opaco foglia con ante **Era** in vetro trasparente e telaio in laccato opaco foglia, ripiani retroilluminati e interno in finitura rovere miele, basamento in laccato ossidato brunito. Tavolo **Hanami** con gambe in finitura noce canaletto e piano in marmo grigio Oriente opaco, sedie **Rose** con struttura in finitura noce canaletto, seduta e schienale imbottiti in tessuto Levante 06.

^{EN} **Belt** sideboard in foglia matt lacquered finish with **Era** transparent glass doors featuring foglia matt lacquered frame, backlit shelves, interior in rovere miele finish, and oxidized bronze lacquered base. **Hanami** table with legs in noce canaletto finish and matt grigio Oriente marble top, **Rose** chairs with frame in noce canaletto finish, padded seat and back in Levante 06 fabric.



IT Madia Belt con frontali Rays in laccato opaco marino. Mensole Ellie in laccato metal ottone. Pouf Loto in tessuto Memory 05.

EN Belt sideboard with Rays fronts in marino matt lacquered finish. Ellie shelves in brass metal lacquered finish. Loto ottoman in Memory 05 fabric.

TECHNICAL DATA

– Belt 90

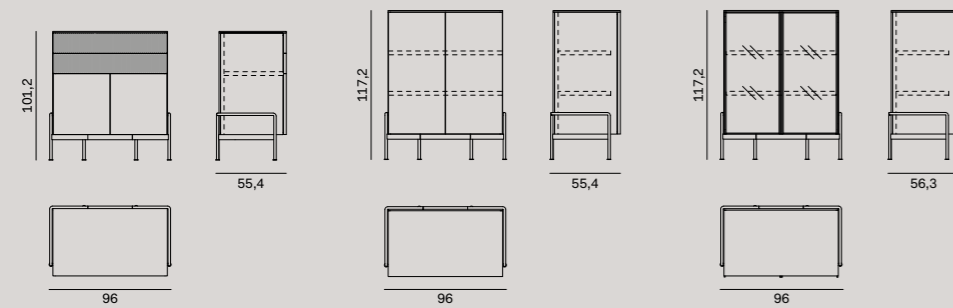

– Belt 120

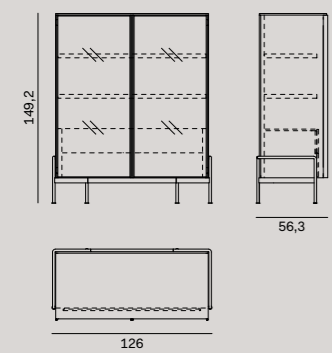

CLOSE-UP

Dettaglio del basamento in metallo visto dal retro. / Rear view of the metal base.

SET INSPIRATION

^{IT} Sullo sfondo, madia Belt in laccato opaco blu notte. In primo piano, madia Belt con frontali Rays in laccato opaco fango, ante Era in vetro cannettato e telaio in laccato opaco fango, interni in finitura rovere carbone e basamento in laccato ossidato brunito.

^{EN} In the background: Belt sideboard in blu notte matt lacquered finish. In the foreground: Belt sideboard with Rays fronts in fango matt lacquered finish, Era reeded glass doors and fango matt lacquered finish frame, interior in rovere carbone finish, and oxidized bronze lacquered base.



TECHNICAL DATA

– Belt 135



– Belt 180

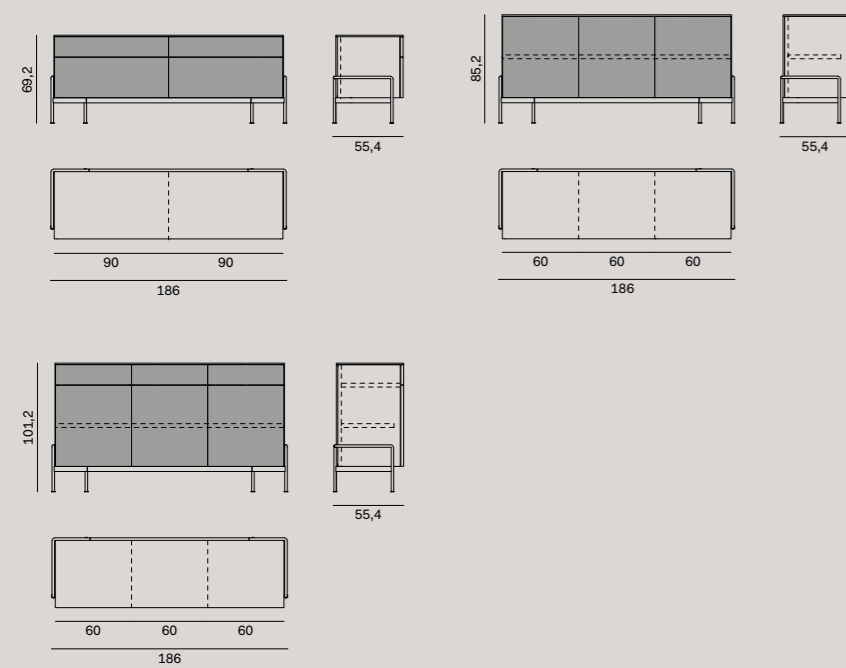

SET INSPIRATION

^{IT} In primo piano, madia **Belt** in laccato opaco ginepro con ante **Era** in vetro cannettato e telaio in alluminio brunito. Sullo sfondo, madia **Belt** in laccato opaco sabbia con frontali **Rays** in finitura noce canaletto. Pouf **Chico** in ecopelle Slim 11.

^{EN} In the foreground: **Belt** sideboard in ginepro matt lacquered finish with **Era** reeded glass doors and bronze-finish aluminium frame. In the background: **Belt** sideboard in sabbia matt lacquered finish with **Rays** fronts in noce canaletto finish. **Chico** ottoman in Slim 11 imitation leather.



Cleo

— Design by Studio Gherardi



La maniglia sottile e il basamento leggero in metallo sono i dettagli che caratterizzano la madia Cleo, disponibile nelle finiture noce e olmo termotrattato, in impiallacciato di rovere, in tutti i colori laccati opachi, lucidi e ossidati, oppure ancora in argilla. Maniglia e basamento si abbinano scegliendo tra le tonalità laccate opache o ossidate per un effetto tono su tono, metal per un tocco prezioso.

The slim handle and light metal base are distinctive details of the Cleo sideboard, which comes in the noce and olmo termotrattato finishes, in the rovere veneers, in any of the matt, gloss and oxidized lacquered colours, or in the clay options. Matt or oxidized lacquered colours can be chosen for the handle and base to match the doors for a tone-on-tone effect, while the metal lacquered option gives a luxe feel.





IT Madie **Cleo** in finitura argilla fumo con maniglie e basamenti in laccato opaco quarzo. Tavolo **Sunny** con gambe in laccato ossidato brunito e piano in pietra lavica nera opaca, sedie **Time** in ecopelle Slim 20.

EN **Cleo** sideboards in fumo clay finish, with quarzo matt lacquered handles and bases. **Sunny** table with oxidized bronze lacquered legs and matt black lava stone top, **Time** chairs in Slim 20 imitation leather.



TECHNICAL DATA

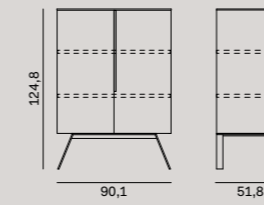

IT Madia Cleo in finitura rovere terra con maniglia e basamento in laccato metal ottone.

EN Cleo sideboard in rovere terra finish with handle and base in brass metal lacquered finish.

Float

— Design by Zaven



La madia Float gioca sul concetto di sostegno e contenitore: il basamento diventa elemento progettuale da valorizzare ed esporre, rendendone visibile la funzione. La madia è disponibile in tre varianti – quadrata, rettangolare alta e rettangolare bassa, a due, tre o quattro ante – e in tutti i colori laccati opachi e ossidati; il basamento è anche in laccato metal.

The Float sideboard plays with the concept of support and storage: the base becomes a design element to be shown off to full effect, putting its function in clear view. The sideboard comes in three versions – square, tall rectangular and low rectangular with two, three or four doors – and in any of the matt or oxidized lacquered colours; the base also comes in the metal lacquered finish.

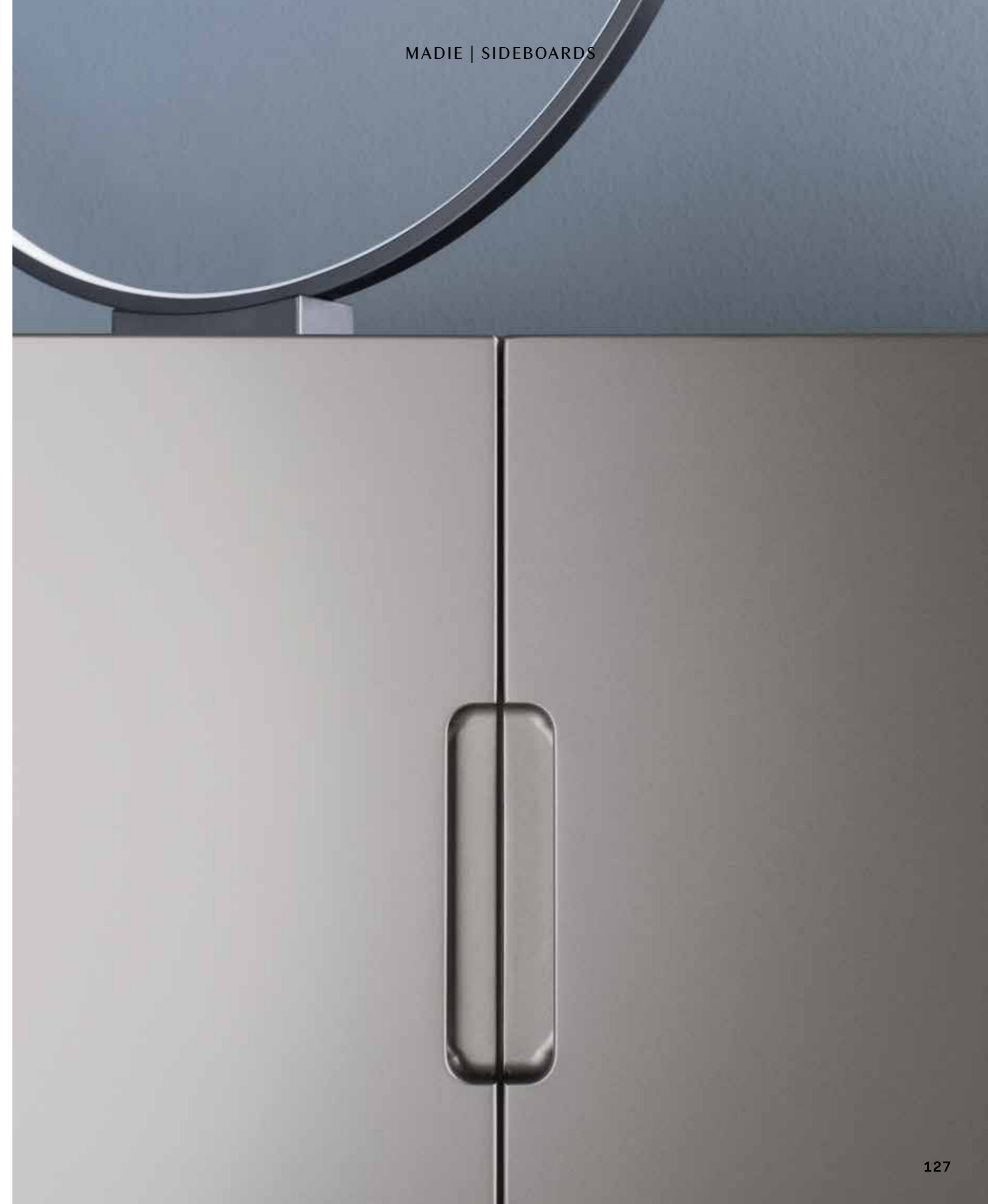

IT Madia Float in laccato ossidato peltro con basamento in laccato ossidato brunito. Libreria Wall 30 in laccato opaco piombo. Poltrona Haiku con scocca in tessuto Allen 06, cuscini in tessuto Allen 30 e basamento in laccato ossidato brunito. Tavolino Fly in finitura rovere carbone.

EN Float sideboard in oxidized pewter lacquered finish with oxidized bronze lacquered base. Wall 30 bookcase in piombo matt lacquered finish. Haiku armchair with shell in Allen 06 fabric, cushions in Allen 30 fabric and base in oxidized bronze lacquered finish. Fly occasional table in rovere carbone finish.



TECHNICAL DATA

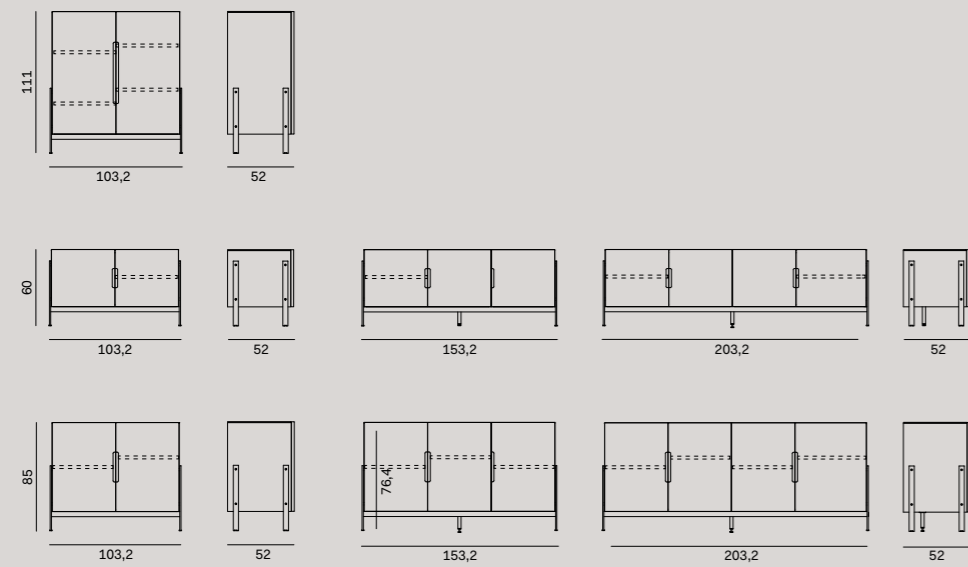

SET INSPIRATION

^{IT} Sullo sfondo, madia Float in laccato ossidato brunito. In primo piano, madia Float in laccato opaco bianco con basamento in laccato opaco quarzo.

^{EN} In the background: Float sideboard in oxidized bronze lacquered finish. In the foreground: Float sideboard in bianco matt lacquered finish with quarzo matt lacquered base.

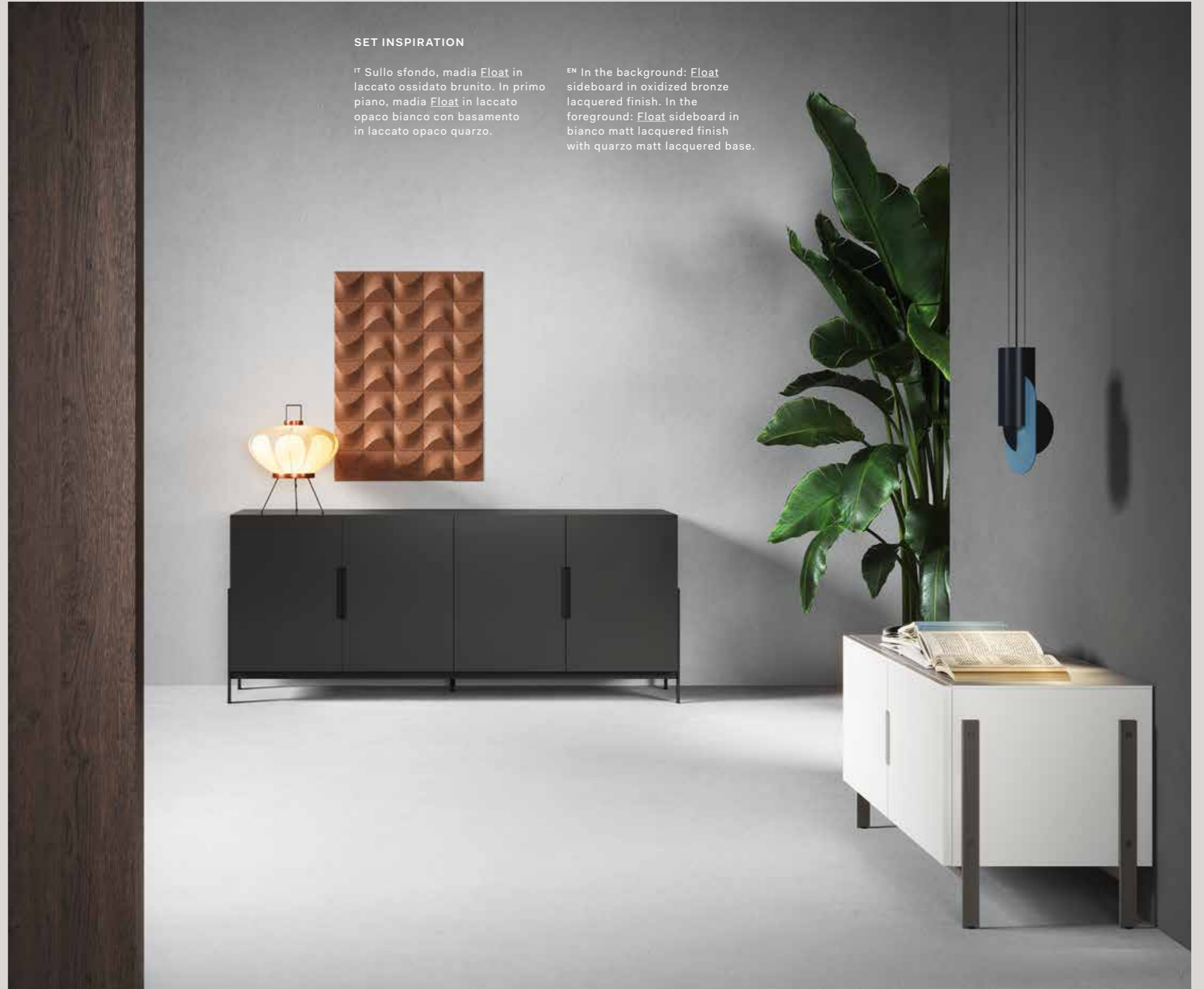

Rim



La madia Rim è un contenitore che affianca vani chiusi e vani a giorno, in un gioco di pieni e vuoti che arreda con personalità qualsiasi spazio. La scocca, disponibile nelle finiture noce e olmo termotrattato e in tutti i colori laccati opachi e ossidati, si abbina ai frontali nelle stesse finiture e in laccato lucido e ai vani a giorno in laccato opaco o ossidato. La madia, disponibile in tre varianti, è completata dal basamento, da scegliere nelle due altezze 15 o 24 cm, in laccato opaco, ossidato o metal.

The Rim sideboard is a unit that teams closed storage with open shelving, the juxtaposition of solids and voids allowing it to furnish any space with personality. The carcass – which comes in the noce or olmo termotrattato finishes, or any of the matt and oxidized lacquered colour options – is paired with fronts in the same finishes as well as the gloss lacquered option, and with open shelving in a matt or oxidized lacquered finish. Adding the finishing touch to the sideboard, which comes in three versions, is the base, which has two height options – 15 or 24 cm – and is available in a choice of matt, oxidized or metal lacquered finishes.



DETAILS COLLECTION

^{IT} Madia Rim in finitura noce con vani a giorno in laccato opaco magnolia su basamento H 24 cm in laccato ossidato brunito. Poltrona Haiku con scocca e cuscini in tessuto Allen 06, basamento in laccato ossidato brunito.

^{EN} Rim sideboard in noce finish with magnolia matt lacquered open shelving on base H 24 cm in oxidized bronze lacquered finish. Haiku armchair with shell and cushions in Allen 06 fabric, base in oxidized bronze lacquered finish.



MADIE | SIDEBARDS





^{IT} Madia Rim in laccato opaco ginepro con frontali in laccato lucido ginepro su basamento H 15 cm in laccato ossidato brunito. Poltrona Origin in tessuto Mood 40. Specchio Deep in laccato ossidato brunito con luce LED integrata.

^{EN} Rim sideboard in ginepro matt lacquered finish with ginepro gloss lacquered fronts on oxidized bronze lacquered base H 15 cm. Origin armchair in Mood 40 fabric. Deep mirror in oxidized bronze lacquered finish with built-in LED lighting.

TECHNICAL DATA



SET INSPIRATION

^{IT} Madia Rim in finitura olmo termotrattato con vani a giorno e basamento H 15 cm in laccato ossidato bronzo. Pouf Loto in tessuto Levante 18. Specchio Deep in laccato ossidato bronzo con luce LED integrata.

^{EN} Rim sideboard in olmo termotrattato finish with open shelving and base H 15 cm in oxidized light bronze lacquered finish. Loto ottoman in Levante 18 fabric. Deep mirror in oxidized light bronze lacquered finish with built-in LED lighting.



Shadows

— Design by Giopato & Coombes



Come una cornice, un'elegante gola racchiude e definisce il perimetro di Shadows. La madia, disponibile in due dimensioni che uniscono ante e cassetti, è proposta in tutti i colori laccati opachi e ossidati con basamento nelle stesse finiture e in cromo lucido o in laccato metal.

Like a frame, an elegant recess runs all the way round the edge of the doors, outlining the Shadows unit. The sideboard – which comes in two sizes, combining doors and drawers – is available in any of the matt and oxidized lacquered colour options and has a base in the same finish, polished chrome or one of the metal lacquered colours.





^{IT} Madia **Shadows** con struttura e basamento in laccato opaco grigio e frontali in laccato opaco blu notte.

^{EN} **Shadows** sideboard with structure and base in grigio matt lacquered finish, and blu notte matt lacquered fronts.

TECHNICAL DATA

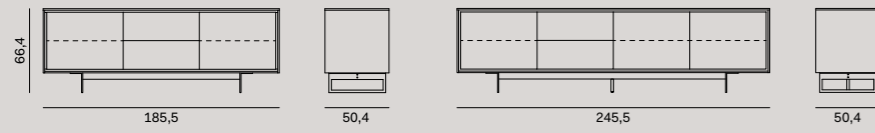

SET INSPIRATION

^{IT} Madia *Shadows* in laccato opaco sabbia. Sedia *Rose* con struttura in finitura rovere carbone, seduta e schienale imbottiti in ecopelle Slim 11. Mensole *Ellie* in laccato ossidato brunito.

^{EN} *Shadows* sideboard in sabbia matt lacquered finish. *Rose* chair with frame in rovere carbone finish, padded seat and back in Slim 11 imitation leather. *Ellie* shelves in oxidized bronze lacquered finish.



Stripe

— Design by Tormena Neadesign



Il basamento sottile e le linee verticali sul fronte caratterizzano il disegno della madia Stripe, disponibile a tre o quattro ante. Numerose le finiture disponibili, che offrono infinite possibilità di personalizzazione. Alla struttura, in tutti i colori laccati opachi, lucidi e ossidati, si abbina il top nelle stesse finiture, o in noce e olmo termotrattato, oppure ancora in tutte le tonalità del rovere o in noce canaletto, in marmo, pietra lavica, light stone, argilla o cuoio. Il basamento è proposto in cromo lucido e in laccato opaco, ossidato o metal.

The slim base and vertical lines on the front are the distinguishing design features of the Stripe sideboard, which comes in a three- or four-door version. There are numerous finishes on offer, providing endless scope for customizing. The structure – in any of the matt, gloss and oxidized lacquered colour options – is paired with a top in the same finish, or in the noce or olmo termotrattato finish, or any of the various rovere options, in addition to noce canaletto, marble, lava stone, light stone, clay or leather. The base comes in polished chrome, or in the matt, oxidized or metal lacquered finishes.





^{IT} Madia Stripe in laccato opaco bianco con top in marmo bianco di Carrara opaco e basamento in laccato ossidato brunito. Divano Reef in tessuto Rice 45.

^{EN} Stripe sideboard in bianco matt lacquered finish with matt bianco Carrara marble top and base in oxidized bronze lacquered finish. Reef sofa in Rice 45 fabric.



^{IT} Madia Stripe in laccato opaco piombo con top in cuoio finitura scoglio. Libreria Pontile con montanti in alluminio brunito, ripiani e listelli frontali in laccato ossidato brunito. Poltrona Haiku in tessuto Allen 06, basamento in laccato ossidato brunito.

^{EN} Stripe sideboard in piombo matt lacquered finish with leather top in scoglio finish. Pontile bookcase with bronze-finish aluminium uprights, shelves and front strips in oxidized bronze lacquered finish. Haiku armchair in Allen 06 fabric, base in oxidized bronze lacquered finish.

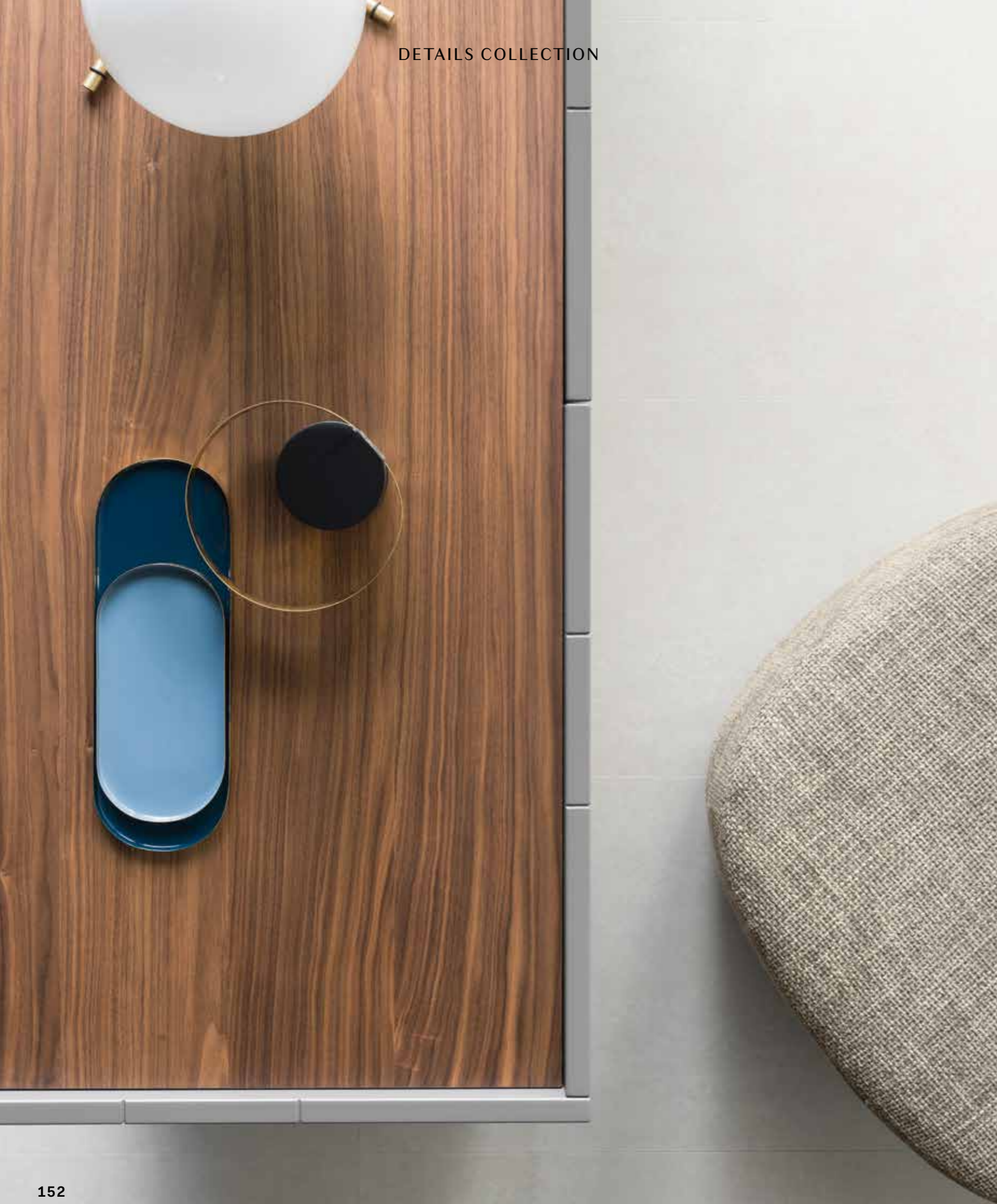

TECHNICAL DATA

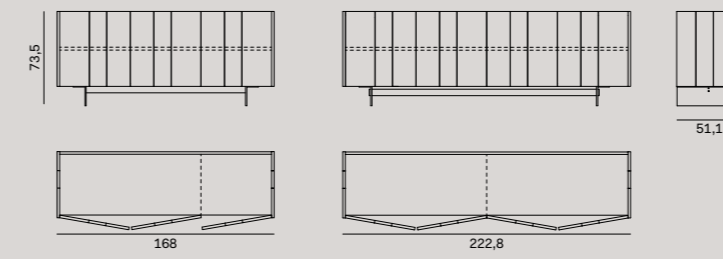

^{IT} Madia **Stripe** in laccato opaco cenere con top in finitura noce canaletto. Pouf **Loto** in tessuto Memory 12.

^{EN} **Stripe** sideboard in cenere matt lacquered finish with top in noce canaletto finish. **Loto** ottoman in Memory 12 fabric.

Reverse

— Design by Studio Gherardi



Ispirata alle madie anni Cinquanta, Reverse è proposta in tre misure. L'alternanza di pieni e vuoti moltiplica le combinazioni cromatiche. La struttura e i vani a giorno sono disponibili nelle finiture noce e olmo termotrattato, oppure in laccato opaco o ossidato. Il basamento può essere in laccato opaco, ossidato o metal.

Inspired by Fifties sideboards, Reverse comes in a choice of three sizes. An alternating succession of solid elements and voids allows for multiple colourways. The structure and open shelving are available in the noce and olmo termotrattato finishes, or matt and oxidized lacquered finishes. The base comes in the matt, oxidized or metal lacquered finishes.

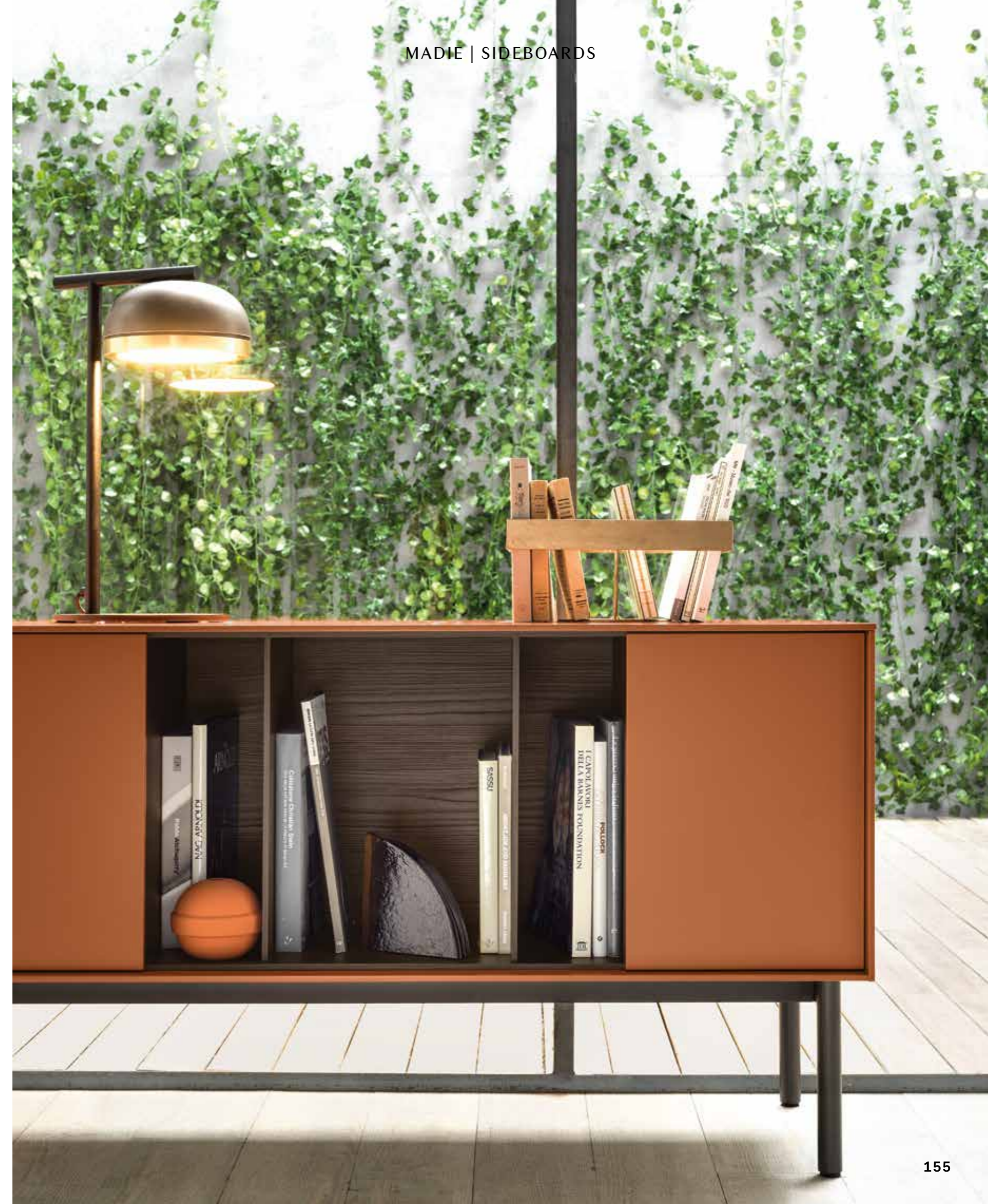

IT Madia **Reverse** in laccato opaco sandalo con vano a giorno in finitura olmo termotrattato e basamento in laccato ossidato brunito. Sedia **Navy Tub** con struttura in finitura rovere terra e seduta in ecopelle Slim 20.

EN **Reverse** sideboard in sandalo matt lacquered finish with open shelving in olmo termotrattato finish and oxidized bronze lacquered base. **Navy Tub** chair with frame in rovere terra finish and seat in Slim 20 imitation leather.

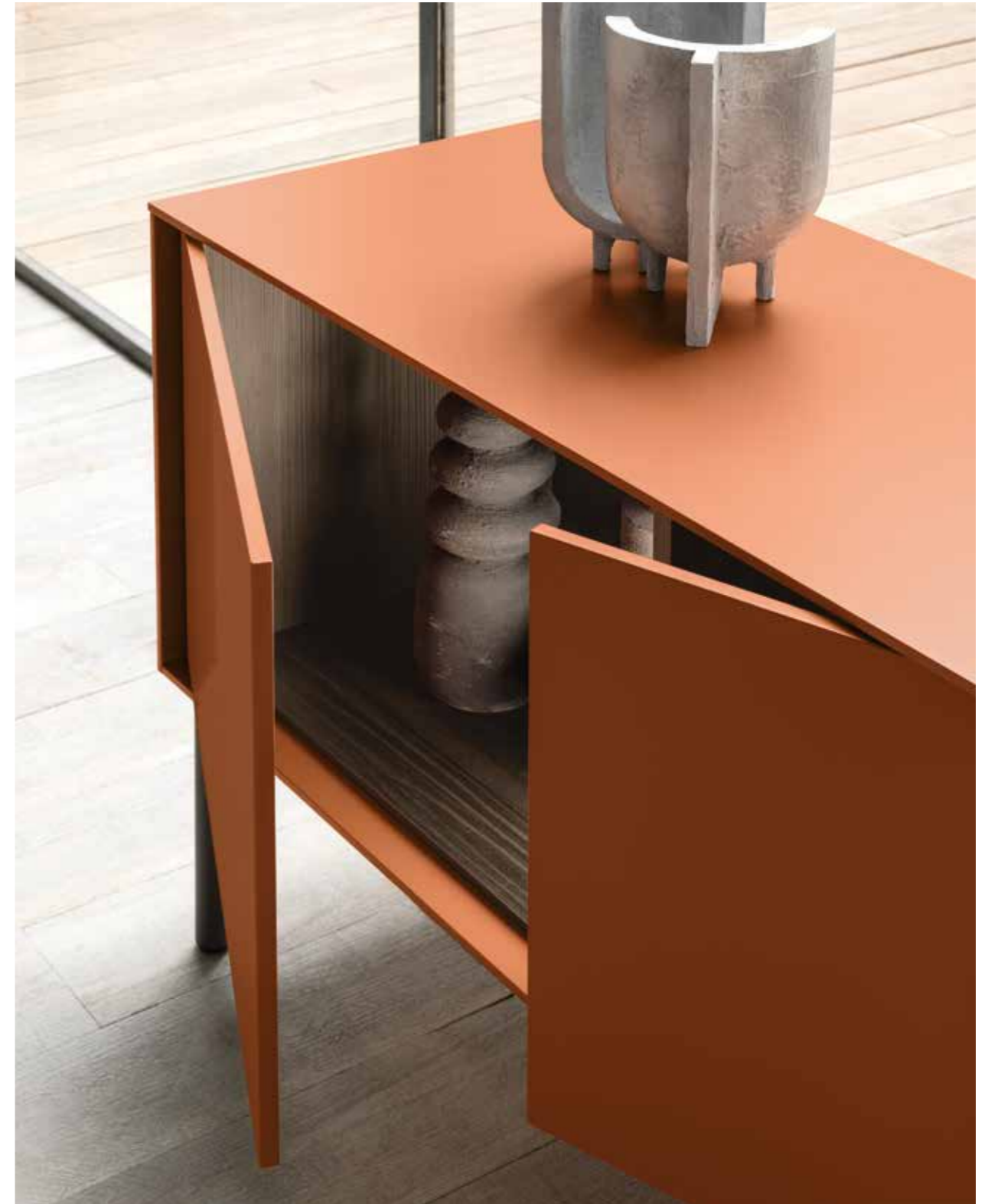

TECHNICAL DATA

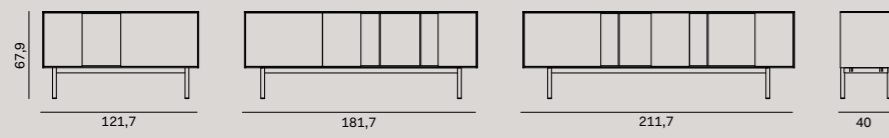

SET INSPIRATION

^{IT} Madia Reverse in finitura noce con vani a giorno e basamento in laccato opaco fango. Poltrona Origin in tessuto Rice 11.

^{EN} Reverse sideboard in noce finish with open shelving and base in fango matt lacquered finish. Origin armchair in Rice 11 fabric.



Tavolini

*Occasional
tables*



Fly

— Design by Zaven

Fly è una collezione di tavolini composta di numerosi elementi, da usare singolarmente o accostare tra loro. La semplicità della giunzione tra le gambe e il piano permette di progettare molte combinazioni, scegliendo tra diverse altezze, forme e materiali. Le gambe sono disponibili in tutte le finiture impiallacciate di rovere e in noce canaletto. Il piano – rotondo, ovale o rettangolare – nella stessa finitura delle gambe, in marmo o in pietra lavica.

Fly is a collection of occasional tables made up of numerous elements, for use on their own or in groupings. The simplicity of the joint between the legs and top means you can design countless combinations, choosing from different heights, shapes and materials. The legs are available in any of the rovere and noce canaletto veneers. The top – round, oval or rectangular – can be in the same finish as the legs, or in marble or lava stone.





^{IT} Tavolini *Fly-c* in finitura rovere carbone e *Fly-o* con gambe in finitura rovere carbone e piano in pietra lavica opaca. Poltrona *Artichoke* in ecopelle Slim 11. Divano *Noa* in tessuto Memory 18. Libreria *Wall 30* in laccato opaco piombo, boiserie in finitura rovere carbone e basi *Box 18* in laccato ossidato brunito.

^{EN} *Fly-c* occasional table in rovere carbone finish and *Fly-o* occasional table with legs in rovere carbone finish and matt lava stone top. *Artichoke* armchair in Slim 11 imitation leather. *Noa* sofa in Memory 18 fabric. *Wall 30* bookcase in piombo matt lacquered finish, wall panelling in rovere carbone finish and oxidized bronze lacquered *Box 18* base units.



TECHNICAL DATA

– Fly-c

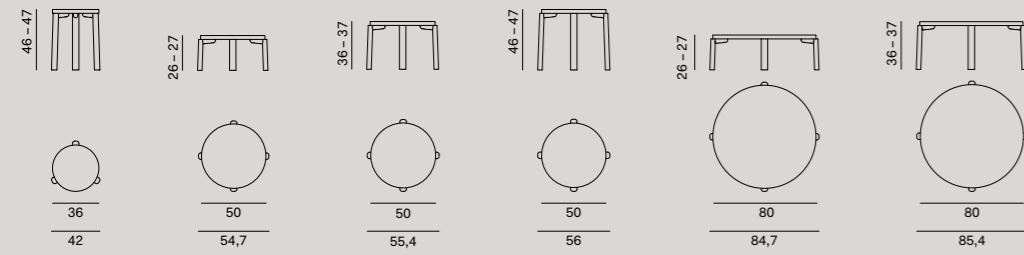

– Fly-o

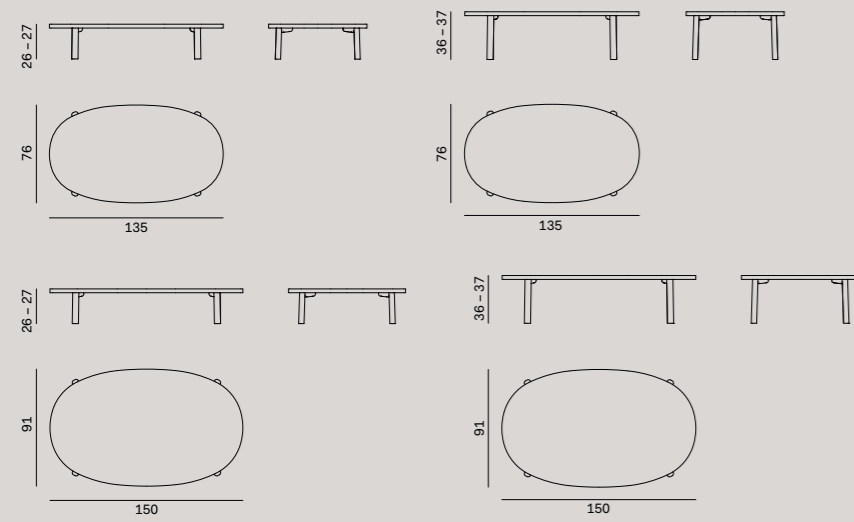

– Fly-q

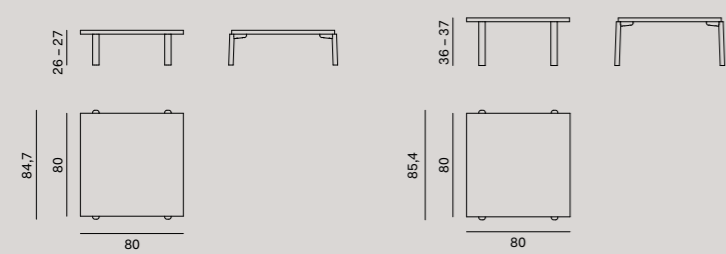

– Fly-r

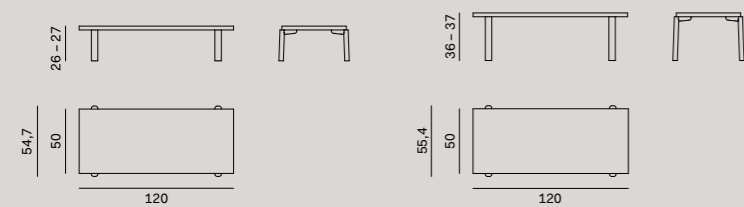

FOCUS

^{IT} A sinistra: tavolini **Fly-r** in finitura rovere miele, con gambe in finitura rovere miele e piano in pietra lavica opaca. A destra: tavolino **Fly-q** con gambe in finitura rovere terra e piano in marmo bianco di Carrara opaco. In primo piano: tavolini **Fly-c** con gambe in finitura rovere chiaro e piano in marmo verde Guatemala lucido e in finitura noce canaletto.

^{EN} Left: **Fly-r** occasional tables in rovere miele finish, with legs in rovere miele finish and matt lava stone top. Right: **Fly-q** occasional table with rovere terra legs and matt bianco Carrara marble top. Front: **Fly-c** occasional tables, one with rovere chiaro legs and polished verde Guatemala marble top, the other in noce canaletto finish.



Cliff

— Design by Matteo Zorzenoni

La collezione di tavolini Cliff nasce dall'idea di portare nell'ambiente domestico un oggetto dall'aspetto monolitico e dalla forte personalità. Realizzato in poliuretano, è disponibile in due altezze e nelle finiture laccate opache oppure ossidate. Grazie alle sue forme dolci e alle svariate cromie in cui è presentato caratterizza qualsiasi spazio in cui viene collocato.

The Cliff occasional table collection evolved from the idea of bringing a monolithic-looking object with a strong personality into a home interior. Made from polyurethane, it comes in two heights and either the matt or oxidized lacquered finishes. With its soft shapes and wide range of colour options, it adds character to whatever space it is set in.

^{IT} Tavolini Cliff in laccato ossidato peltro e laccato opaco sabbia. Poltrona Velvet in tessuto Coco 28.

^{EN} Cliff occasional tables in oxidized pewter lacquered and sabbia matt lacquered finishes. Velvet sofa in Coco 28 fabric.



TECHNICAL DATA

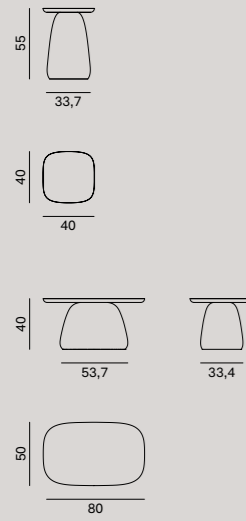

SET INSPIRATION

^{IT} Tavolini Cliff in laccato ossidato brunito e in laccato opaco senape. Poltrone Onni in tessuto Levante 06 con basamento in laccato ossidato brunito. Libreria Pontile con ripiani in finitura rovere carbone, montanti e listelli frontali in alluminio brunito.

^{EN} Cliff occasional tables in oxidized bronze lacquered and senape matt lacquered finishes. Onni armchairs in Levante 06 fabric with oxidized bronze lacquered base. Pontile bookcase with shelves in rovere carbone finish, bronze-finish aluminium uprights and front strips.

Kin

— Design by Zanellato/Bortotto

Per il suo aspetto sofisticato, il tavolino Kin è pensato per essere protagonista al centro del living. Le gambe sottili in metallo sostengono due piani posti ad altezze diverse, in quattro diverse configurazioni. Le gambe sono disponibili in laccato opaco, ossidato e metal, mentre i piani in finitura olmo termotrattato o noce, oltre che in laccato opaco, ossidato, lucido e metal.

With its sophisticated appearance, the Kin coffee table has been designed to take centre stage in the living room. The slim metal legs support two tops placed at different heights, in four different configurations. The legs come in the matt, oxidized and metal lacquered finishes, while tops are available in the olmo termotrattato or noce finish, in addition to the matt, oxidized, gloss and metal lacquered options.

^{IT} Tavolino Kin-o con gambe in laccato opaco ginepro e piani in laccato opaco e lucido ginepro. Tavolino Kin-c con gambe in laccato metal ottone e piani in laccato opaco foresta e in finitura noce. Divano Mac in tessuto Milton 06 con cuscini nei tessuti Season 21, Storm 21 e 41.

^{EN} Kin-o coffee table with ginepro matt lacquered legs and tops in ginepro matt and gloss lacquered finishes. Kin-c coffee table with brass metal lacquered legs and tops in foresta matt lacquered and noce finishes. Mac sofa in Milton 06 fabric with cushions in Season 21, Storm 21 and 41 fabrics.



TECHNICAL DATA

— Kin-c

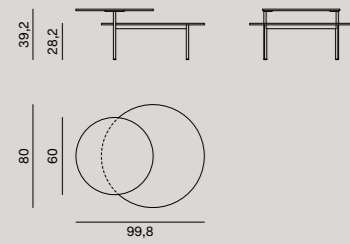

— Kin-o

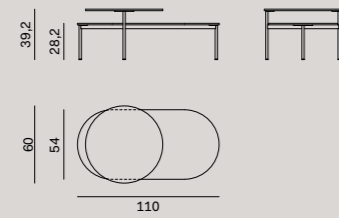

— Kin-q

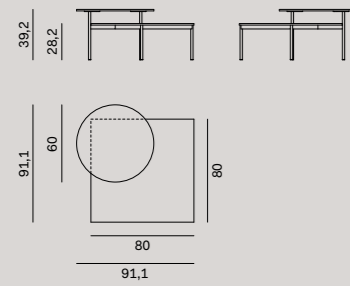

— Kin-r

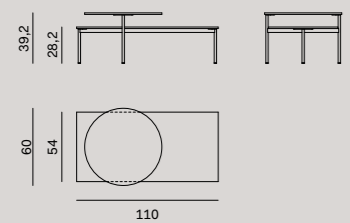

FOCUS

^{IT} Da sinistra: tavolino Kin-r con gambe in laccato ossidato brunito e piani in laccato opaco tiglio e laccato ossidato brunito. Tavolino Kin-q con gambe in laccato ossidato brunito e piani in finitura olmo termotrattato e laccato opaco sabbia.

^{EN} From left: Kin-r coffee table with oxidized bronze lacquered legs and tops in tiglio matt lacquered and oxidized bronze lacquered finishes. Kin-q coffee table with oxidized bronze lacquered legs and tops in olmo termotrattato and sabbia matt lacquered finishes.



Orbis

— Design by Studio Gherardi

Orbis è una collezione di tavolini circolari resi particolari dall'asimmetria delle gambe. Con due altezze e un'ampia gamma di finiture, permette di creare soluzioni sempre diverse che danno ritmo alla zona living. Il piano è disponibile in tutte le varianti laccate, in finitura noce e olmo termotrattato, in impiallacciato di rovere e noce canaletto, in argilla, light stone, marmo e pietra lavica. Le gambe in laccato opaco, ossidato e metal.

Orbis is a collection of circular occasional tables that owe their quirky look to the asymmetry of the legs. With two heights and an extensive range of finishes to choose from, you can create a never-ending array of solutions to bring the living area to life. The top is available in any of the lacquered options, in the noce and olmo termotrattato finishes, in the rovere and noce canaletto veneers, as well as in clay, light stone, marble and lava stone. Legs come in the matt, oxidized and metal lacquered finishes.



^{IT} Tavolini **Orbis** in laccato ossidato brunito e con gambe in laccato opaco ginepro e piano in marmo verde Guatemala opaco. Pouf **Tamburello** in tessuto Rice 12. Mensole **Ellie** in laccato ossidato brunito.

^{EN} **Orbis** occasional tables in oxidized bronze lacquered finish and with matt verde Guatemala marble top on ginepro matt lacquered legs. **Tamburello** ottoman in Rice 12 fabric. **Ellie** shelves in oxidized bronze lacquered finish.

TECHNICAL DATA

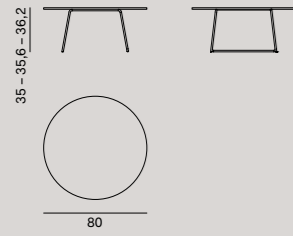
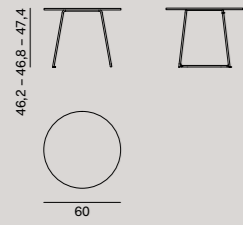

FOCUS

^{IT} Tavolini Orbis, da sinistra: in finitura laccato opaco ginepro; con gambe in laccato opaco nero grafite e piano in pietra lavica nera opaca; con gambe in laccato metal ottone e piano in finitura olmo termotrattato; con gambe in laccato ossidato brunito e piano in finitura argilla fumo; con gambe in laccato opaco piombo e piano in finitura rovere chiaro.

^{EN} Orbis occasional tables, from left: in ginepro matt lacquered finish; with legs in nero grafite matt lacquered finish and matt black lava stone top; with brass metal lacquered legs and top in olmo termotrattato finish; with oxidized bronze lacquered legs and top in fumo clay finish; with piombo matt lacquered legs and top in rovere chiaro finish.



Globe

— Design by Novamobili studio

Globe è una collezione di tavolini dal gusto ricercato e moderno. La struttura essenziale a T – in metallo laccato opaco, ossidato o metal – sostiene un piano spesso cinque centimetri nelle finiture impiallacciate di rovere o noce canaletto, oppure un vassoio in metallo, che a sua volta accoglie un piano in finitura noce o olmo termotrattato, in impiallacciato di rovere e noce canaletto, laccato opaco, ossidato e lucido oppure ancora in light stone, marmo, pietra lavica o cuoio. Disponibile in tre diametri e tre altezze, Globe è un tavolino davvero trasversale, adatto a stili e ambienti diversi.

Globe is a collection of occasional tables with a stylish, modern feel. The pared-back T-shaped structure – in the matt, oxidized or metal lacquered finish – supports a 5cm-thick top in either one of the rovere and noce canaletto veneers, or a metal tray, which in turn accommodates an insert in one of the following finishes: noce or olmo termotrattato, rovere and noce canaletto veneers, matt, oxidized or gloss lacquered finish, or one of the light stone, marble, lava stone or leather options. Available in a choice of three diameters and three heights, Globe is a truly cross-functional occasional table, suiting different styles and rooms.

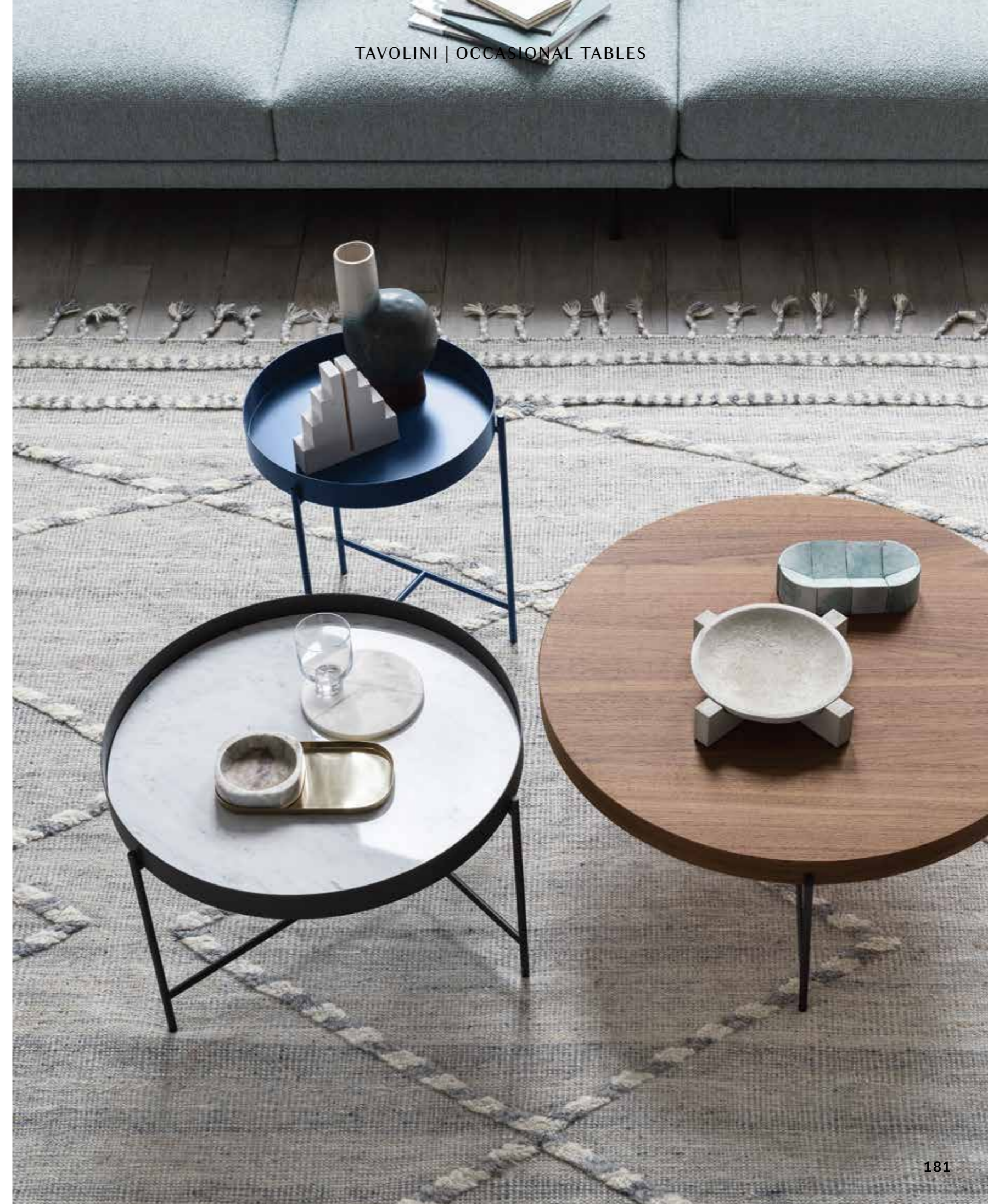



^{IT} Sullo sfondo, tavolino **Globe** in laccato opaco blu notte. In primo piano, tavolini **Globe** con struttura in laccato ossidato brunito e piano per vassoio in marmo bianco di Carrara lucido, con struttura in laccato ossidato brunito e piano sp. 5 cm in finitura noce canaletto. Divano **Noa** in tessuto Storm 15. Pouf **Loto** in tessuto Memory 05. Contenitore sospeso **Outline** in laccato ossidato brunito.

^{EN} In the background: **Globe** side table in blu notte matt lacquered finish. In the foreground, **Globe** occasional tables with oxidized bronze lacquered structure and polished bianco Carrara marble tray top; with oxidized bronze lacquered structure and 5cm-thick top in noce canaletto finish. **Noa** sofa in Storm 15 fabric. **Loto** ottoman in Memory 05 fabric. **Outline** wall unit in oxidized bronze lacquered finish.

TECHNICAL DATA

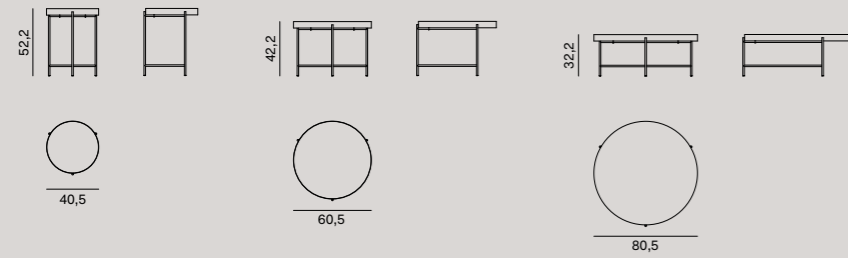

FOCUS

^{IT} Dal fondo: tavolini Globe in laccato metal rame; con struttura in laccato ossidato brunito e piano sp. 5 cm in finitura rovere carbone; con struttura in laccato opaco visone e piano per vassoio in cuoio finitura testa di moro; con struttura in laccato opaco nero grafite e piano per vassoio in light stone nero.

^{EN} From back: Globe occasional tables in copper metal lacquered finish; with oxidized bronze lacquered structure and 5cm-thick top in rovere carbone finish; with visone matt lacquered structure and leather tray top in testa di moro finish; with nero grafite matt lacquered structure and nero light stone tray top.



Team

— Design by Studio Gherardi

Rettangolare o quadrato, Team è un tavolino leggero in metallo che per la sua essenzialità si presta agli ambienti più diversi. È disponibile in tutti i colori laccati opachi, ossidati e metal, e reso ancora più prezioso dai piani in finitura noce o olmo termotrattato, impiallacciato di rovere e noce canaletto o ancora in light stone bianco o nero.

Rectangular or square, Team is a light metal occasional table whose unfussy nature allows it to sit happily in all manner of interiors. It is available in any of the matt, oxidized and metal lacquered colour options, while tops in the noce or olmo termotrattato finish, rovere or noce canaletto veneers, or bianco or nero light stone give it an even more luxe feel.



^{IT} Tavolini Team-r con struttura in laccato ossidato brunito e piano in light stone bianco, Team-q in laccato ossidato brunito. Poltrona Artichoke in ecopelle Slim 11.

^{EN} Team-r occasional table with oxidized bronze lacquered structure and bianco light stone top; Team-q occasional table in oxidized bronze lacquered finish. Artichoke armchair in Slim 11 imitation leather.

TECHNICAL DATA

— Team-q

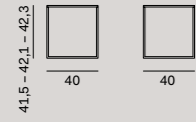

— Team-r

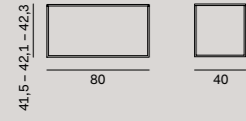

FOCUS

IT A sinistra: tavolini Team-r con struttura in laccato opaco nero grafite e piano in light stone nero; con struttura in laccato ossidato peltro e piano in finitura olmo termotrattato. A destra: tavolini Team-q in laccato opaco granato; con struttura in laccato ossidato brunito e piano in finitura noce canaletto.

EN Left: Team-r occasional tables, one with nero grafite matt lacquered structure and top in nero light stone, the other with oxidized pewter lacquered structure and top in olmo termotrattato finish. Right: Team-q occasional tables, one in granato matt lacquered finish, the other with oxidized bronze lacquered structure and top in noce canaletto finish.



Trio

— Design by Novamobili studio

Proposto in due altezze, il tavolino Trio è un comodo appoggio accanto al divano oppure, se viene collocato vicino al letto, un pratico comodino. Con il piano circolare sorretto da tre gambe, è disponibile in tutti i colori laccati opachi, ossidati e metal.

Available in a choice of two heights, the Trio side table serves as a convenient surface next to the sofa or, placed next to the bed, as a practical nightstand. Featuring a circular top sitting on three legs, it is available in any of the matt, oxidized and metal lacquered colour options.

^{IT} Tavolini Trio in laccato opaco grigio e marino. Poltrona Origin in tessuto Milton 05. Mensole Ellie in laccato ossidato brunito.

^{EN} Trio side tables in grigio and marino matt lacquered finishes. Origin armchair in Milton 05 fabric. Ellie shelves in oxidized bronze lacquered finish.



TECHNICAL DATA



SET INSPIRATION

^{IT} Tavolini Trio in laccato opaco quarzo e granato e in laccato ossidato brunito. Divano Mac in tessuto Storm 12 con cuscini nei tessuti Storm 12 e 18 e Milton 29. Pensili Box 18 in laccato opaco quarzo con ante Era in vetro cannettato e telaio in alluminio brunito.

^{EN} Trio side tables in quarzo and granato matt lacquered and oxidized bronze lacquered finishes. Mac sofa in Storm 12 fabric with cushions in Storm 12 and 18 and in Milton 29 fabrics. Box 18 wall units in quarzo matt lacquered finish with Era reeded glass doors and bronze-finish aluminium frame.



Circle

— Design by Studio Gherardi

Il tavolino Circle si caratterizza per il design semplice e moderno. La struttura in metallo, nei diversi colori laccati opachi, ossidati e metal, sostiene un doppio piano di forma circolare che lo rende pratico accanto al divano, ma anche come comodino.

The Circle occasional table features a simple, modern design. The metal structure, in the various matt, oxidized and metal lacquered colour options, supports circular tops in a two-tier arrangement, which makes it a practical addition beside the sofa, as well as a handy bedside table.



IT Tavolino Circle in laccato ossidato brunito. Libreria Wall 12 in laccato opaco quarzo e poltrona Reef in tessuto Urban 41.

EN Circle occasional table in oxidized bronze lacquered finish. Wall 12 bookcase in quartz matt lacquered finish and Reef armchair in Urban 41 fabric.

TECHNICAL DATA



SET INSPIRATION

^{IT} Tavolini Circle in laccato metal rame e in laccato opaco marino. Divano e poltrona Velvet in tessuto Levante 08, cuscini in tessuto Levante 18.

^{EN} Circle occasional tables in copper metal lacquered finish and in marino matt lacquered finish. Velvet sofa and armchair in Levante 08 fabric, cushions in Levante 18 fabric.

Seven

— Design by Studio Gherardi

Il tavolino Seven, nella sua duplice versione quadrata e rettangolare, appare come un monolite scavato e leggermente sollevato da terra. Si caratterizza per il gioco cromatico dei materiali tra scocca interna ed esterna, vani a giorno e vassoi estraibili. È disponibile nelle finiture noce e olmo termotrattato e in tutti i colori laccati opachi e ossidati.

The Seven coffee table – in both square and rectangular versions – has the appearance of a carved-out solid block hovering just above the floor. Its distinguishing feature is the juxtaposition of colour between the materials of the interior and exterior, open shelving and pull-out trays. It comes in the noce and olmo termotrattato finishes, and in any of the matt and oxidized lacquered colour options.

^{IT} Tavolini Seven in laccato ossidato peltro con vassoi in finitura olmo termotrattato. Poltrona Origin in tessuto Levante 05 e divano Mac in tessuto Milton 06.

^{EN} Seven coffee tables in oxidized pewter lacquered finish with trays in olmo termotrattato finish. Origin armchair in Levante 05 fabric and Mac sofa in Milton 06 fabric.



TECHNICAL DATA

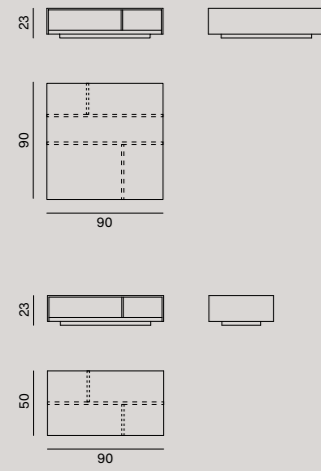

SET INSPIRATION

^{IT} Tavolini Seven in finitura noce con vassoi in laccato opaco foglia. Poltrone Reef in tessuto Hive 40 con cuscini in tessuto Memory 21 e Fog 21. Contenitori sospesi Outline in laccato metal rame.

^{EN} Seven coffee tables in noce finish with foglia matt lacquered trays. Reef armchairs in Hive 40 fabric with cushions in Memory 21 and Fog 21 fabrics. Outline wall units in copper metal lacquered finish.



Shadows

— Design by Giopato & Coombes

Shadows è un tavolino dalla forma semplice e regolare, costituito da due parallelepipedi sovrapposti che, leggermente sollevati da terra, creano un interessante gioco di ombre sul pavimento. È disponibile in tutti i colori laccati opachi e ossidati, e nelle finiture rovere chiaro, rovere miele, rovere terra, rovere carbone e noce canaletto.

Shadows is a coffee table with a simple, regular-shaped design consisting in two parallelepipeds, one sitting on top of the other and raised slightly to create an interesting play of shadows on the floor. It comes in any of the matt and oxidized lacquered colour options, and in the rovere chiaro, rovere miele, rovere terra, rovere carbone and noce canaletto finishes.

IT Tavolini Shadows in finitura rovere miele. Composizione a parete con boiserie sp. 2,7 cm in finitura rovere miele e laccato opaco ginepro, mensole Duo e panca sp. 5 cm nella stessa finitura. Pensili e basi Box 18 con gola e frontali Rays in laccato opaco fango. Divano Mac in tessuto Milton 06 con cuscino in tessuto Season 21 e pouf Loto in tessuto Storm 39.

EN Shadows coffee tables in rovere miele finish. Wall-mounted arrangement with 2,7cm-thick wall panelling in rovere miele and ginepro matt lacquered finishes, Duo shelves and 5cm-thick bench in the same finish. Box 18 wall and base units with profile and Rays fronts in fango matt lacquered finish. Mac sofa in Milton 06 fabric with cushion in Season 21 fabric. Loto ottoman in Storm 39 fabric.



TECHNICAL DATA

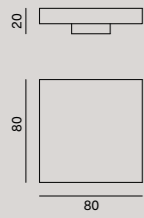

SET INSPIRATION

^{IT} Tavolini Shadows in laccato opaco sandalo. Divano Reef in tessuto Milton 11 con cuscini in tessuto Milton 42 e 28. Madaia sospesa composta da contenitori Outline con telaio in laccato ossidato brunito, scocca e schiena in finitura rovere carbone e contenitori Tetris in laccato ossidato brunito con cassetti in cuoio finitura scoglio.

^{EN} Shadows coffee tables in sandalo matt lacquered finish. Reef sofa in Milton 11 fabric with cushions in Milton 42 and 28 fabrics. Wall-mounted sideboard comprising Outline units with oxidized bronze lacquered frame, carcass and back panel in rovere carbone finish, and Tetris storage units in oxidized bronze lacquered finish with leather drawers in scoglio finish.



Allout

— Design by Novamobili studio

Allout è un tavolino versatile: d'appoggio per la zona giorno, diventa un capiente comodino per la zona notte. La sua forma circolare consente di sfruttare al meglio lo spazio interno grazie al cassetto con presa sul bordo superiore dell'anta. È disponibile in tutti i colori laccati opachi.

Allout is a versatile occasional table: serving as a useful set-down space in the living room, it turns into a capacious bedside table in the bedroom. Its circular shape means it has plenty of storage space inside, which is exploited to the full with a drawer featuring a grip edge at the top of the front. It is available in any of the matt lacquered colour options.

IT Tavolino Allout in laccato opaco granato e letto Velvet in tessuto Levante 47.

EN Allout occasional table in granato matt lacquered finish and Velvet bed in Levante 47 fabric.



TECHNICAL DATA

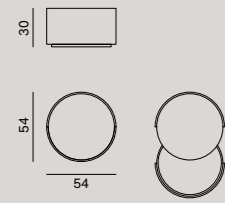

SET INSPIRATION

^{IT} Tavolini Allout in laccato opaco ginepro e quarzo. Divano Avenue in tessuto Memory 12 e cuscini in tessuto Memory 12 e 35. Mensole Duo in laccato opaco quarzo. Boiserie sp. 2,7 cm in finitura rovere chiaro e in laccato opaco quarzo.

^{EN} Allout occasional tables in ginepro and quarzo matt lacquered finishes. Avenue sofa in Memory 12 fabric and cushions in Memory 12 and 35 fabrics. Duo shelves in quarzo matt lacquered finish. 2,7 cm-thick wall panelling in rovere chiaro finish and quarzo matt lacquered finish.



Accessori

Accessories



Freebook

— Design by Tormena Neadesign

Freebook è una libreria composta da cubi in metallo sovrapponibili e multidirezionali, capaci di colorare e personalizzare gli ambienti domestici. In versione a uno, due e tre moduli, Freebook si presta a essere usata anche come tavolino accanto a poltrone e divani. È disponibile in tutti i colori laccati opachi, ossidati e metal.

Freebook is a bookcase made up of multi-directional metal cubes that can be stacked on top of each other, injecting colour and individuality into home interiors. Available as a single-, double- or three-module unit, Freebook also lends itself to use as a side table next to armchairs and sofas. It comes in any of the matt, oxidized and metal lacquered colour options.

^{IT} Librerie **Freebook** in laccato opaco bianco e foglia. Sedia **Natt** con struttura in laccato opaco cenere e seduta in tessuto Urban 06.

^{EN} **Freebook** bookcases in bianco and foglia matt lacquered finishes. **Natt** chair with cenere matt lacquered frame and seat in Urban 06 fabric.



TECHNICAL DATA

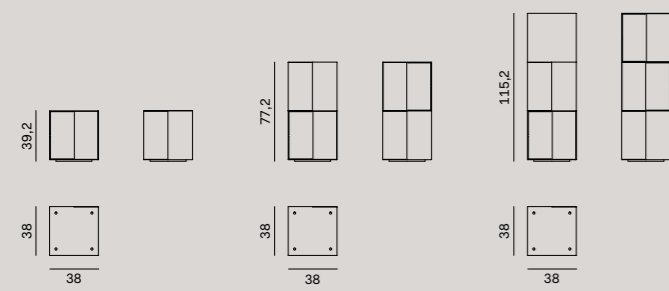

SET INSPIRATION

IT Libreria Freebook in laccato metal ottone. Poltrona Artichoke in tessuto Opera 18 e cuscino in tessuto Opera 54. Madia Cleo in laccato lucido blu notte con maniglia e basamento in laccato opaco blu notte.

EN Freebook bookcase in brass metal lacquered finish. Artichoke armchair in Opera 18 fabric and cushion in Opera 54 fabric. Cleo sideboard in blu notte gloss lacquered finish with handle and base in blu notte matt lacquered finish.



Odette

— Design by Novamobili studio

Verticale o orizzontale, da appoggio o da parete, lo specchio Odette esprime un gusto semplice e raffinato. La cornice è disponibile nelle finiture noce o olmo termotrattato e in tutti i colori laccati opachi e ossidati.

Vertical or horizontal, set on the floor or mounted on a wall... whatever its situation, the Odette mirror embodies simplicity and refinement. The frame comes in the noce or olmo termotrattato finish, and in any of the matt and oxidized lacquered colour options.

^{IT} Specchio Odette in laccato ossidato bronzo. Tavolino Cliff in laccato ossidato peltro.

^{EN} Odette mirror in oxidized light bronze lacquered finish. Cliff occasional table in oxidized pewter lacquered finish.



TECHNICAL DATA

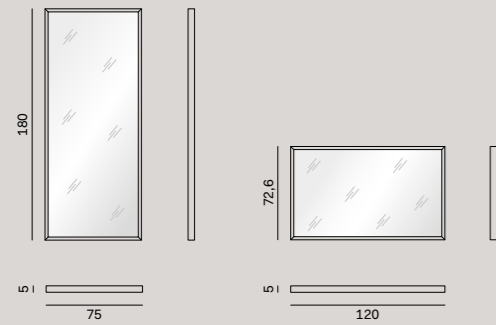

SET INSPIRATION

^{IT} Specchio *Odette* in laccato ossidato brunito, mensola sp. 5 cm nella stessa finitura. *Basi Box 18* con frontali *Rays*, top e fianco in finitura noce canaletto e gola in laccato ossidato brunito, cuscini in tessuto *Hive 21* e *Milton 28*. Pouf *Tamburello* in tessuto *Milton 28*. Poltrona *Haiku* in tessuto *Milton 01* e basamento in laccato opaco tortora.

^{EN} *Odette* mirror in oxidized bronze lacquered finish, 5cm-thick shelf in the same finish. *Box 18* base units with *Rays* fronts, top and side panel in noce canaletto finish and oxidized bronze lacquered profile, cushions in *Hive 21* and *Milton 28* fabrics. *Tamburello* ottoman in *Milton 28* fabric. *Haiku* armchair in *Milton 01* fabric, and base in tortora matt lacquered finish.



Deep

Deep è uno specchio dalla forma circolare in due varianti, piccola e grande. La struttura, anche con illuminazione LED integrata, è disponibile in tutti i colori laccati opachi, ossidati e metal a catalogo, così da abbinarsi perfettamente agli arredi dell'ingresso, del salotto o della camera da letto.

Deep is a circular mirror that comes in two versions: small and large. The structure, which offers the option of built-in LED lighting, is available in any of the matt, oxidized and metal lacquered colours from the catalogue, meaning it pairs beautifully with entry hall, lounge or bedroom furniture.





TECHNICAL DATA

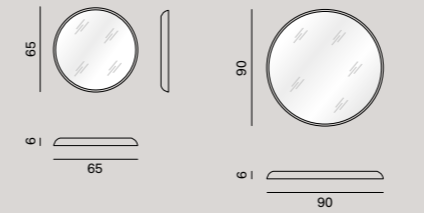

^{IT} Specchi **Deep** in laccato ossidato bronzo. Madia composta da basi **Box 18** in laccato opaco blu notte su basamento **Tube** in laccato ossidato bronzo.

^{EN} **Deep** mirrors in oxidized light bronze lacquered finish. Sideboard comprising **Box 18** base units in blu notte matt lacquered finish on **Tube** base in oxidized light bronze lacquered finish.

Riga

— Design by E-ggs

Riga è una mensola accessoriata che diventa un elemento funzionale da usare in diversi ambienti della casa. Discreta ed essenziale, la mensola si arricchisce di porta oggetti, specchi e appendiabiti per creare composizioni dalle linee leggere e minimali per l'ingresso, il bagno e ovunque ci sia la necessità di appendere abiti e contenere piccoli oggetti. Ampie le possibilità di personalizzazione: la mensola è disponibile in laccato opaco o ossidato, in impiallacciato di rovere o noce canaletto; scaletta porta oggetti e appendiabiti in laccato opaco, ossidato e metal. Lo specchio ovale è in tre dimensioni.

Riga is an accessorized shelf that turns into a functional unit suited to use in various rooms throughout the home. Low-key and pared-back, the shelf is enhanced with the addition of display shelves, mirrors and coat hooks to create clean-lined and minimalist configurations for the entry hall, bathroom, or anywhere else you need to hang up clothes or find a place for small items. Plenty of scope for customizing: the shelf comes in the matt or oxidized lacquered options, and in the rovere or noce canaletto veneers; the display ladder and coat hooks come in the matt, oxidized and metal lacquered finishes. The oval mirror comes in three sizes.





^{IT} Mensola Riga in laccato opaco foresta con scaletta portaoggetti e appendiabiti in laccato ossidato bronzo e specchio.

^{EN} Riga shelf in foresta matt lacquered finish with oxidized light bronze lacquered display ladder and coat hooks, and mirror.



^{IT} Mensola Riga in laccato opaco
quarzo con appendiabiti in laccato
ossidato brunito e specchio.
Madia composta da basi Box 18
in finitura rovere miele con vassoio
3 lati in laccato opaco quarzo,
su basamento Double in laccato
ossidato brunito. Pouf Loto
in ecopelle Slim 20.

^{EN} Riga shelf in quarzo matt
lacquered finish with oxidized
bronze lacquered coat hooks,
and mirror. Sideboard comprising
Box 18 base units in rovere
miele finish with quarzo matt
lacquered 3-sided tray, on
Double base in oxidized bronze
lacquered finish. Loto ottoman
in Slim 20 imitation leather.



IT Mensola Riga in finitura rovere terra con appendiabiti in laccato metal ottone e specchio. Comò Quarantacinque in finitura rovere terra con top in cuoio finitura testa di moro. Poltrona Origin in tessuto Mood 40.

EN Riga shelf in rovere terra finish with coat hooks in brass metal lacquered finish, and mirror. Quarantacinque chest of drawers in rovere terra finish with leather top in testa di moro finish. Origin armchair in Mood 40 fabric.



TECHNICAL DATA

— Conf. 1

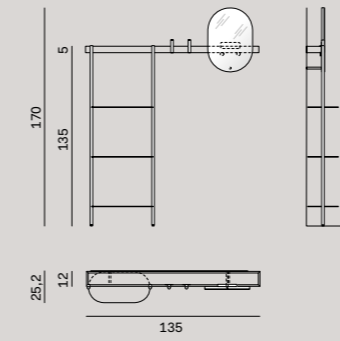

— Conf. 2

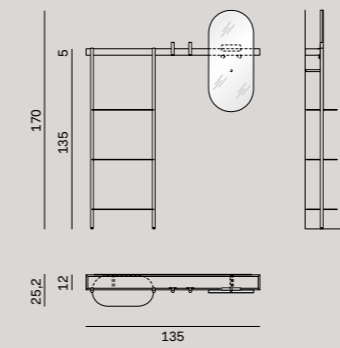

— Conf. 3

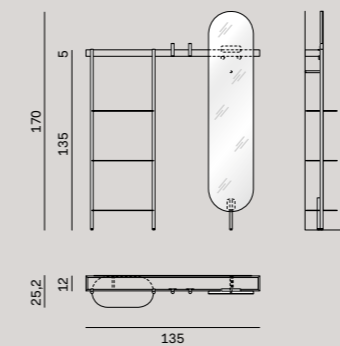

Cube

— Design by E-ggs

Cube è un sistema aperto e flessibile che si compone di panche vassoio e boiserie da attrezzare con pannelli imbottiti, specchi, scrittoi a ribalta, mensole, appendiabiti e tasche portadocumenti. Gli elementi si possono combinare tra loro per creare composizioni funzionali per l'ingresso o la camera da letto, da personalizzare scegliendo tra le molte finiture disponibili, inclusi i tessuti e le ecopelli per i pannelli foderati.

Cube is an open, flexible system made up of tray benches and wall panelling to be accessorized with padded panels, mirrors, drop-down desks, shelves, coat hooks and document pouches. The various accessories can be combined to create functional configurations for the entry hall or bedroom, with a whole host of finishes to choose from to tailor the end result, including fabrics and imitation leather options for the lined panels.





^{IT} Composizione **Cube** in finitura olmo termotrattato con modulo specchiata, moduli foderati in tessuto Storm 18, appendiabiti in laccato metal ottone, tasca in laccato ossidato brunito e scrittoio a ribalta in finitura olmo termotrattato. Panca vassoio **Cube** in finitura olmo termotrattato con cuscino in tessuto Storm 18 e basamento in laccato metal ottone. Pouf **Loto** in tessuto Storm 39.

^{EN} **Cube** configuration in olmo termotrattato finish with mirror module, modules lined in Storm 18 fabric, coat hooks in brass metal lacquered finish, oxidized bronze lacquered pouch and drop-down desk in olmo termotrattato finish. **Cube** tray bench in olmo termotrattato finish with cushion in Storm 18 fabric and base in brass metal lacquered finish. **Loto** ottoman in Storm 39 fabric.

TECHNICAL DATA

— Conf. 1

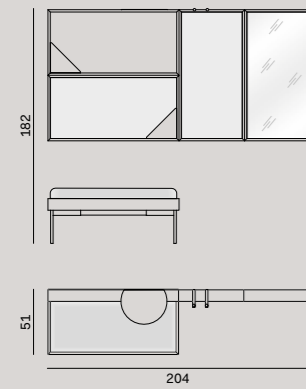

— Conf. 2

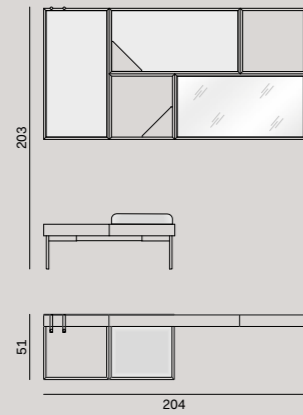

— Conf. 3

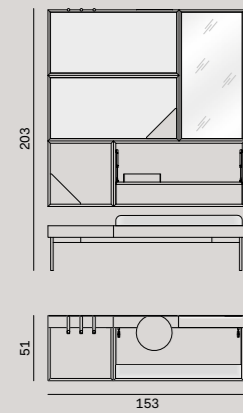

— Conf. 4

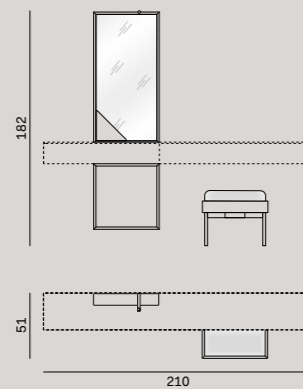

SET INSPIRATION

^{IT} A sinistra: composizione Cube con boiserie, modulo con specchio, tasche triangolari e appendiabiti in laccato opaco blu notte, boiserie foderata in tessuto Milton 05. Panca vassoio Cube in finitura noce con cuscino in tessuto Hive 15 e basamento in laccato opaco blu notte.

A destra: composizione Cube con boiserie e modulo con specchio in finitura noce, appendiabiti e tasca triangolare in laccato opaco piombo. Basi Box 18 sospese in laccato opaco piombo e panca vassoio Cube nella stessa finitura con cuscino in tessuto Urban 18.

^{EN} Left: Cube configuration with wall panelling, mirror module, coat hooks and pouches in blu notte matt lacquered finish, modules lined in Milton 05 fabric. Cube tray bench in noce finish with cushion in Hive 15 fabric and base in blu notte matt lacquered finish. Right: Cube configuration with wall panelling and mirror module in noce finish, coat hook and pouch in piombo matt lacquered finish. Box 18 wall units in piombo matt lacquered finish and Cube tray bench in the same finish with cushion in Urban 18 fabric.



Ninfea

— Design by Zanellato/Bortotto

Ninfea è uno scrittoio dalle forme semplici ed eleganti. Sottili gambe metalliche supportano un piano dalle forme morbide e arrotondate. Il séparé, in tessuto o pelle extra, può essere usato come piccola bacheca su cui appendere appunti e documenti con calamite attratte dall'anima metallica. Lo scrittoio, con pratico cassetto sottopiano, è ideale per ricreare un angolo lettura in camera da letto e si configura anche come toeletta, grazie alla scatola in legno portaoggetti e allo specchio circolare.

Ninfea is a desk with simple, elegant lines. A top with soft, rounded shapes sits on slender metal legs. The privacy screen, in fabric or extra leather, doubles as a little noticeboard for posting notes and documents on using magnets attracted to its metal inner. The desk, which has a handy undermounted drawer, is ideal for recreating a reading nook in the bedroom, and also has a dressing table-esque setup with its wooden caddy and circular mirror.





^{IT} Scrivitoio Ninfea con séparé in tessuto Urban 05, specchio, piano in finitura rovere carbone, cassetto e scatola portaoggetti in laccato opaco blu notte, gambe in laccato ossidato brunito. Sedia Rose con struttura in finitura rovere carbone e seduta in ecopelle Slim 11.

^{EN} Ninfea desk with privacy screen in Urban 05 fabric, mirror, top in rovere carbone finish, drawer and caddy in blu notte matt lacquered finish, oxidized bronze lacquered legs. Rose chair with frame in rovere carbone finish and seat in Slim 11 imitation leather.



TECHNICAL DATA

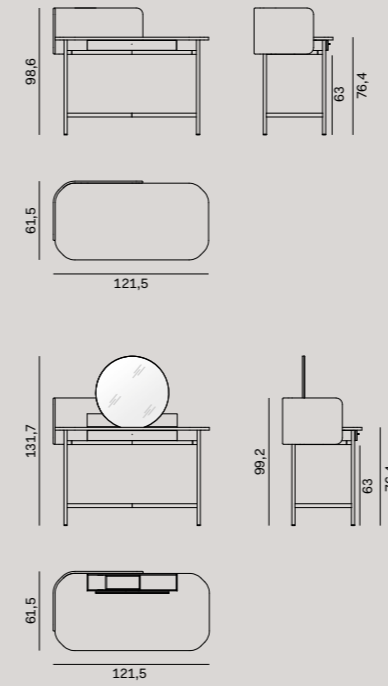

^{IT} Scrivania **Ninfea** con separ  in tessuto Memory 45, piano e cassetto in laccato opaco artico, gambe in laccato ossidato brunito. Pouf **Tamburello** in tessuto Hive 21.

^{EN} **Ninfea** desk with privacy screen in Memory 45 fabric, top and drawer in artico matt lacquered finish, oxidized bronze lacquered legs. **Tamburello** ottoman in Hive 21 fabric.

Finiture e
materiali

*Finishes and
materials*

DETAILS COLLECTION

Laccato opaco all'acqua Water-based matt lacquered

							
300 bianco	351 magnolia	303 tortora	314 corda	333 sabbia	331 visone	324 fango	
							
330 grigio	341 cenere	352 piombo	310 quarzo	318 nero grafite	353 blu notte	347 marino	325 oceano
							
344 avio	339 artico	346 foresta	342 foglia	345 timo	354 tiglio	355 ginepro	348 granato
							
356 sandalò	357 senape						

Laccato ossidato Oxidized lacquered

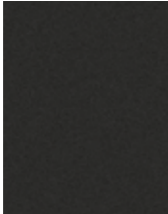
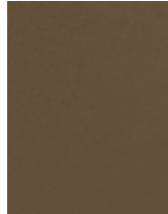
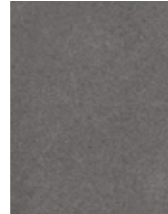
		
306 brunito / bronze	304 bronzo / light bronze	305 peltro / pewter bronze









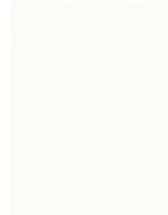

Rays

Laccato opaco e ossidato in tutte le finiture / *Matt and oxidized lacquered in all finishes*



FINITURE | FINISHES



Laccato lucido Gloss lacquered

							
400 bianco	451 magnolia	403 tortora	414 corda	433 sabbia	430 grigio	441 cenere	
							
452 piombo	410 quarzo	418 nero grafite	453 blu notte	447 marino	444 avio	439 artico	455 ginepro
							
456 sandalò							

Laccato metal Metal lacquered

	
307 rame / copper	308 ottone / brass

Vetro temperato Toughened glass

		
C08 trasparente / transparent	C80 fumé / smoked	C81 stop-sol

Vetro cannettato Reeded glass



C02

DETAILS COLLECTION

**Ecolegno
Eco-wood**



72
noce



73
olmo
termotrattato

**Impiallacciato
Veneers**



N04
rovere chiaro

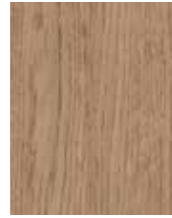

N02
rovere miele



N01
rovere terra



N05
rovere carbone

**Noce
canaletto**



N03
noce canaletto

Rays



N03
noce canaletto

**Argilla
Clay**



A04
pomice

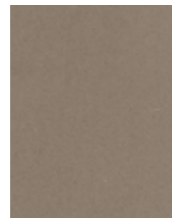

A03
arena



A01
mattone



A02
fumo

FINITURE | FINISHES

Light stone



R01
bianco



R02
nero

**Marmo
Marble**



MM1
bianco Carrara
lucido / polished



MM2
bianco Carrara
opaco / matt

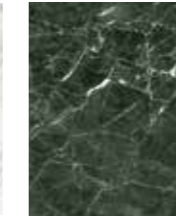

MM5
verde Guatemala
lucido / polished

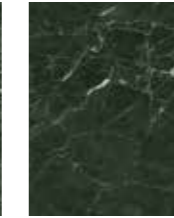

MM6
verde Guatemala
opaco / matt

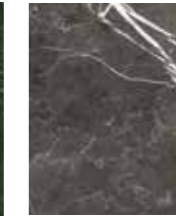

MM3
grigio Oriente
lucido / polished

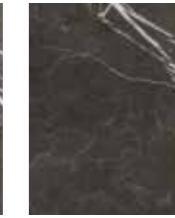

MM4
grigio Oriente
opaco / matt

**Pietra lavica
Lava stone**

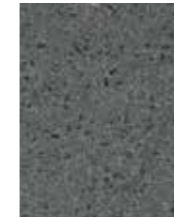

opaca / matt



nera opaca /
matt black

**Cuoio
Leather**



03 W
cognac



03 X
scoglio

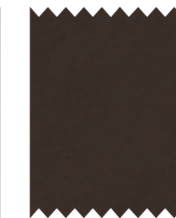

03 T
testa di moro

Accessori / Accessories

CUBE	p. 235, 237
DEEP	p. 45, 53, 88, 136, 139, 223
FREEBOOK	p. 213, 215
NINFEA	p. 241, 243
ODETTE	p. 217, 219
RIGA	p. 107, 227, 228, 230

Contenitori / Storage units

BOX 18	p. 9, 10, 17, 21, 34, 42, 45, 49, 53, 65, 82, 88, 164, 193, 203, 219, 223, 228
OUTLINE	p. 9, 10, 34, 53, 65, 183, 201, 205
TETRIS	p. 42, 45, 205

Comò / Chest of drawers

QUARANTACINQUE	p. 230
-----------------------	--------

Divani / Sofas

AVENUE	p. 209
MAC	p. 173, 193, 199, 203
NOA	p. 164, 183
REEF	p. 149, 205
VELVET	p. 197

Letti / Beds

VELVET	p. 207
---------------	--------

Librerie / Bookcases

PONTILE	p. 9, 25, 95, 151, 171
WALL 12	p. 50, 195
WALL 30	p. 13, 128, 164

Madie / Sideboards

BELT	p. 57, 113, 115, 117, 119
CLEO	p. 40, 123, 125, 215
FLOAT	p. 18, 128, 131
REVERSE	p. 58, 156, 159
RIM	p. 26, 72, 134, 136, 139
SHADOWS	p. 143, 145
STRIPE	p. 33, 149, 151, 153

Mensole / Shelves

DUO	p. 203, 209
ELLIE	p. 45, 75, 101, 115, 145, 177, 191

Poltrone / Armchairs

ARTICHOKE	p. 151, 164, 187, 215
HAIKU	p. 128, 134, 219
ONNI	p. 171
ORIGIN	p. 10, 136, 159, 191, 199, 230
REEF	p. 195, 201
VELVET	p. 169, 197

Pouf / Ottomans

CHICO	p. 119
LOTO	p. 18, 34, 40, 42, 50, 57, 95, 115, 139, 153, 183, 203, 228, 235
TAMBURELLO	p. 25, 26, 45, 177, 219, 243

Sedie / Seating

CANDY	p. 13, 58, 95, 97
CHURCH	p. 107
NATT	p. 25, 88, 91, 213
NAVY	p. 17, 26, 82, 85
NAVY TUB	p. 50, 57, 81, 85, 156
ROSE	p. 9, 33, 45, 49, 65, 66, 69, 113, 145, 241
TIME	p. 18, 34, 42, 53, 101, 103, 123
TWIST	p. 10, 21, 40, 72, 75, 77

Tavoli / Tables

ARGOS	p. 57, 58, 72
FILO	p. 49, 50, 53, 75, 101
HANAMI	p. 9, 10, 13, 65, 66, 113
LEVEL	p. 25, 26
STRETCH	p. 33, 34
SUNNY	p. 40, 42, 45, 81, 123
TORII	p. 17, 18, 21, 82

Tavolini / Occasional tables

ALLOUT	p. 207, 209
CIRCLE	p. 40, 107, 195, 197
CLIFF	p. 169, 171, 217
GLOBE	p. 183, 185
FLY	p. 128, 164, 167
KIN	p. 173, 175
ORBIS	p. 177, 179
SEVEN	p. 199, 201
SHADOWS	p. 203, 205
TEAM	p. 187, 189
TRIO	p. 191, 193

Concept and creative direction

Valeria Carlesso

Art direction

Novamobili studio

Graphic design

dogtrot

Concept image

Novamobili studio

Photography

Studio Emozioni

Beppe Brancato

pp: 5, 61, 66, 67, 109, 141,
142, 147, 148

Styling

Loop Lab:

Luigina Pilloni

Laura Pasqualato

Elena Caponi Studio

pp: 5, 61, 66, 67, 109, 141,
142, 147, 148

Martina Lucatelli, Leandro Favalaro

pp: 207, 211

Rendering

Helios Digital

Colour separation and print

Lucegroup

February 2021

^{IT} Novamobili si riserva in qualsiasi momento la facoltà di apportare tutte le modifiche necessarie al miglioramento funzionale e qualitativo dei propri prodotti. Per ogni aspetto tecnico e dimensionale fare riferimento ai listini aziendali e relativi aggiornamenti. I colori e i materiali riprodotti nelle immagini stampate hanno un valore indicativo. Novamobili declina ogni responsabilità derivante da eventuali inesattezze di stampa e/o da errori sulle caratteristiche dei prodotti forniti.

^{EN} In line with its policy of improving product function and quality, Novamobili reserves the right to make any necessary changes at any time. For information of a technical and dimensional nature, refer to the company price lists and relevant updates. The colours and materials reproduced in the images printed herein are given as an approximate guide only. Novamobili does not accept any responsibility for misprints and/or mistakes in describing the characteristics of the products supplied.

NOVAMOBILI

Novamobili Spa
via G.Pascoli 14
31053 Pieve di Soligo
Treviso – Italia
T +39 0438 98 68
F +39 0438 98 6999
novamobili@novamobili.it



HOME SYSTEM
DAILY INSPIRED

novamobili.it