

**20.70.1202.00**

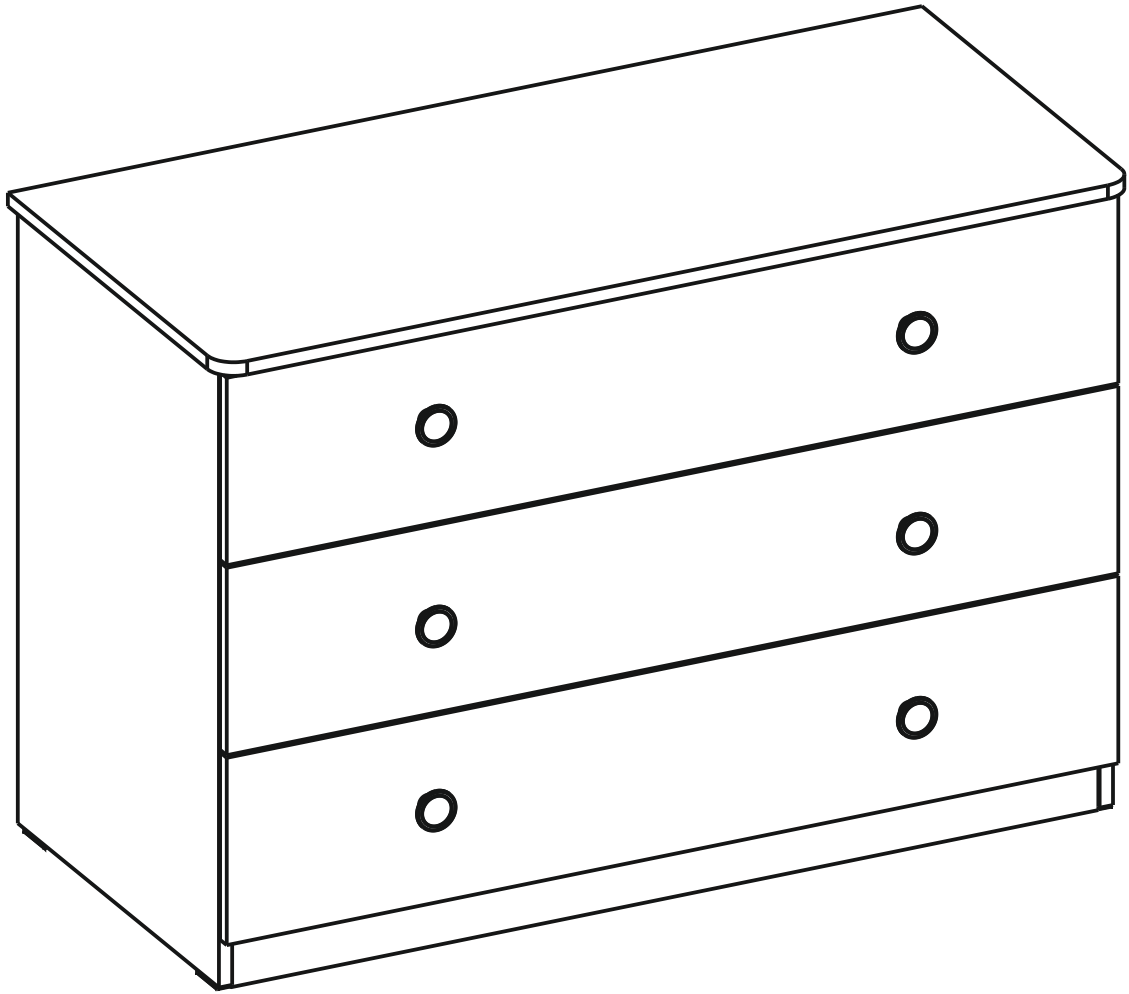

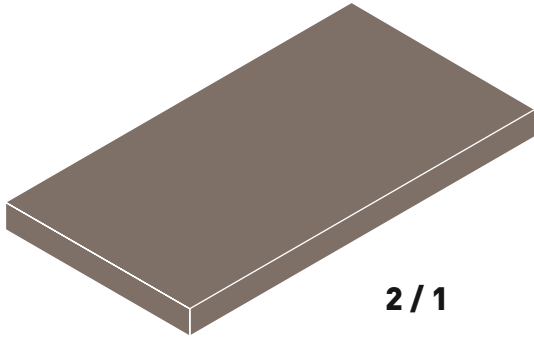

2/1

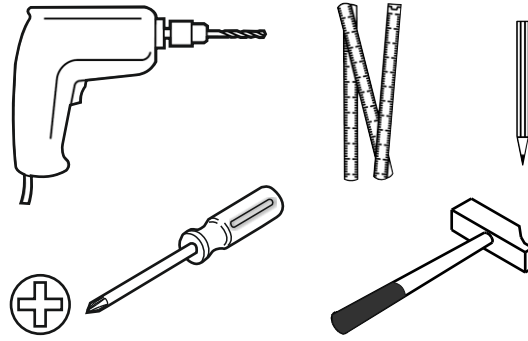
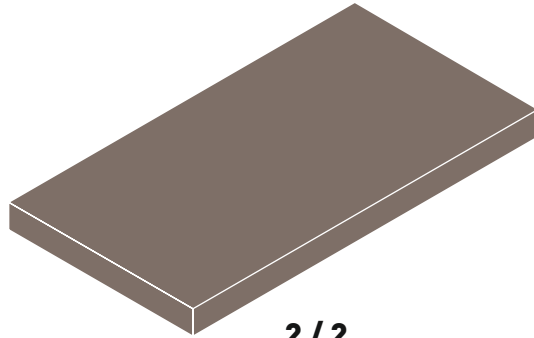

2/2

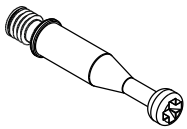

13.07.01.108 x 20



13.07.01.110 x 20

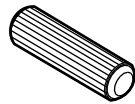

13.01.01.111 x 8

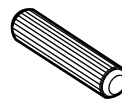

13.01.01.110 x 12



13.01.01.045 x 20



13.01.01.107 x 3

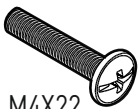

M4X22  
13.03.01.010 x 6

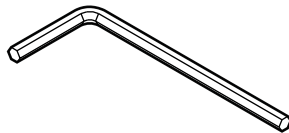

13.07.01.016 x 1

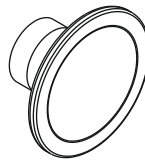

13.06.01.178 x 6

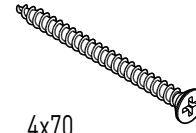

4x70  
13.02.01.011 x 1

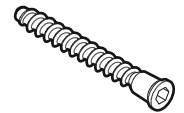

13.02.01.019 x 18

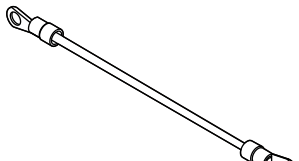

13.07.01.135 x 1



M6X13  
13.03.01.021 x 1

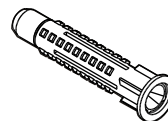

13.01.01.175 x 1

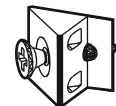

13.01.01.170 x 4

2/1

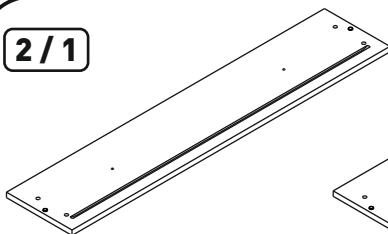

18.70.1202.006 x 1

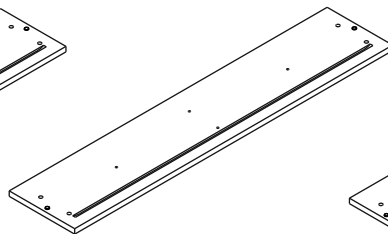

18.70.1202.015 x 1

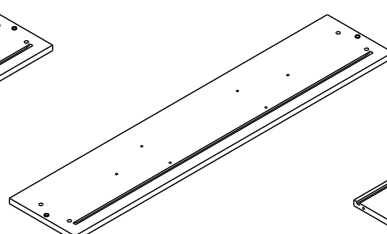

18.70.1202.005 x 1

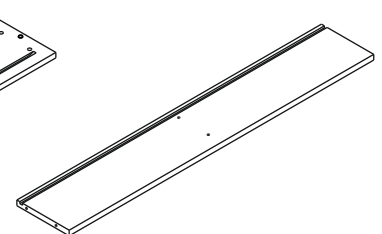

18.70.1202.016 x 1

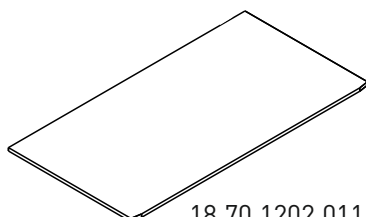

18.70.1202.011 x 3

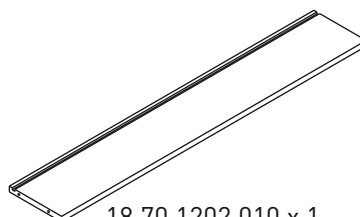

18.70.1202.010 x 1

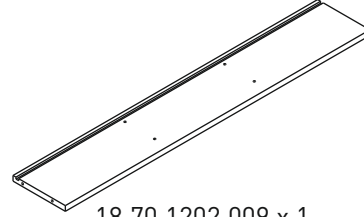

18.70.1202.009 x 1

2/2

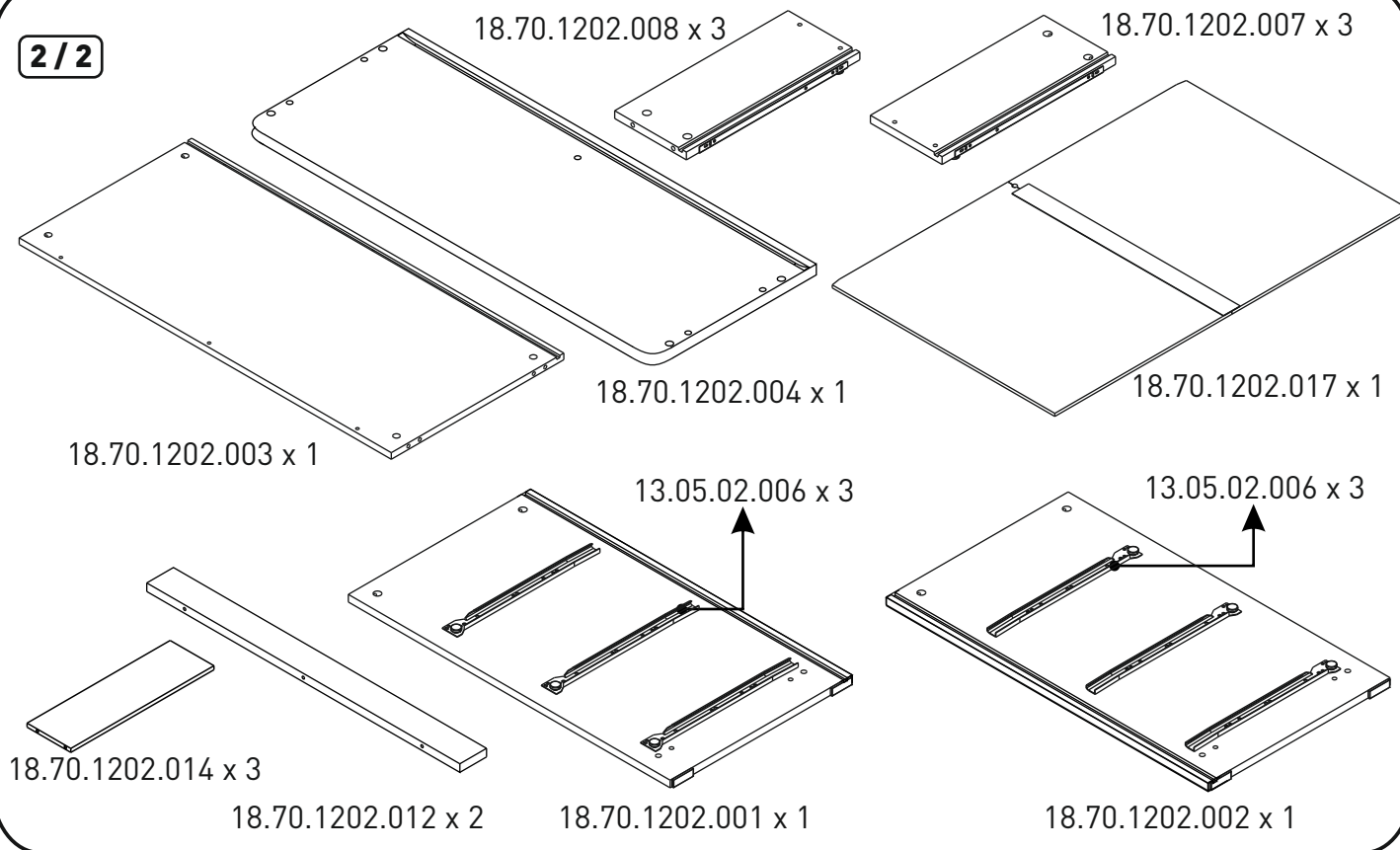

1

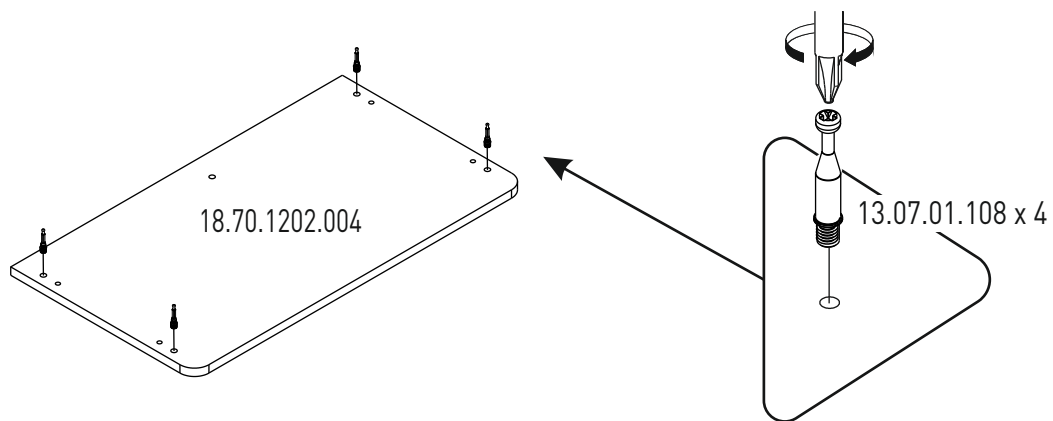

2

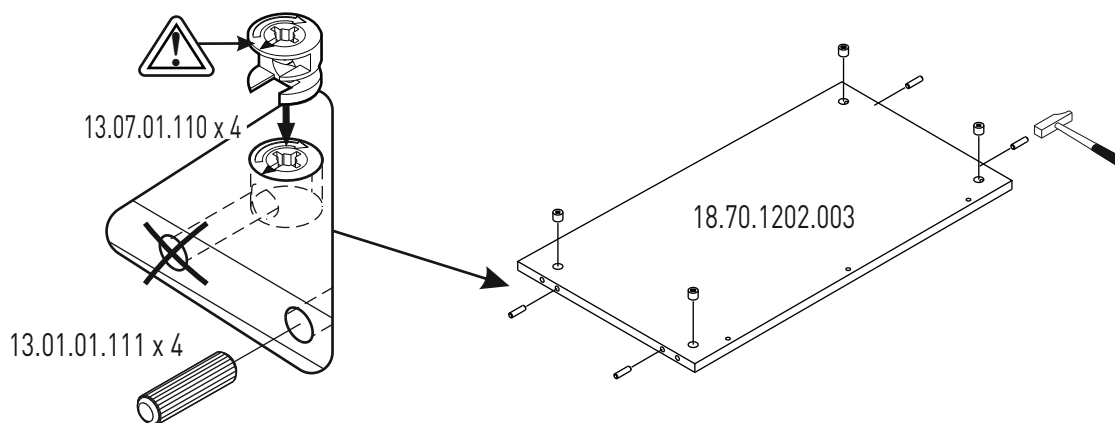

3

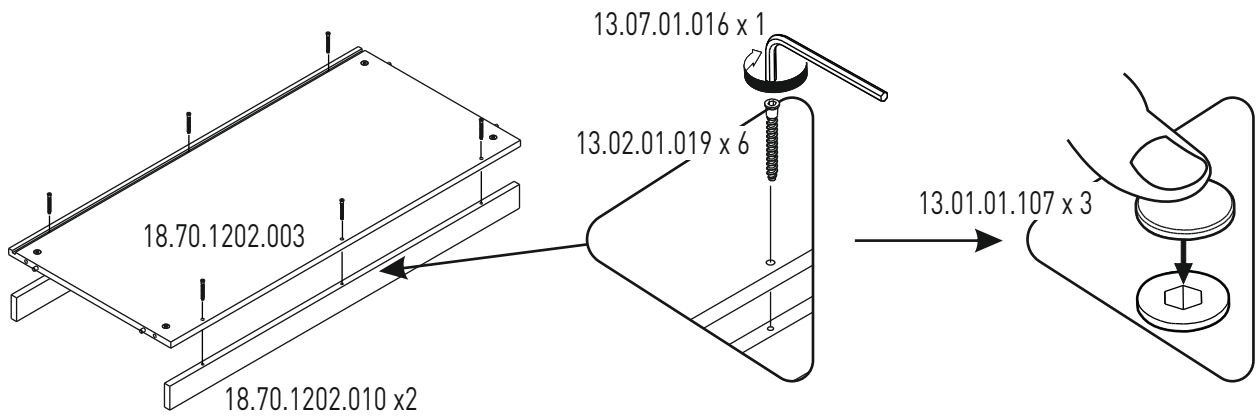

4

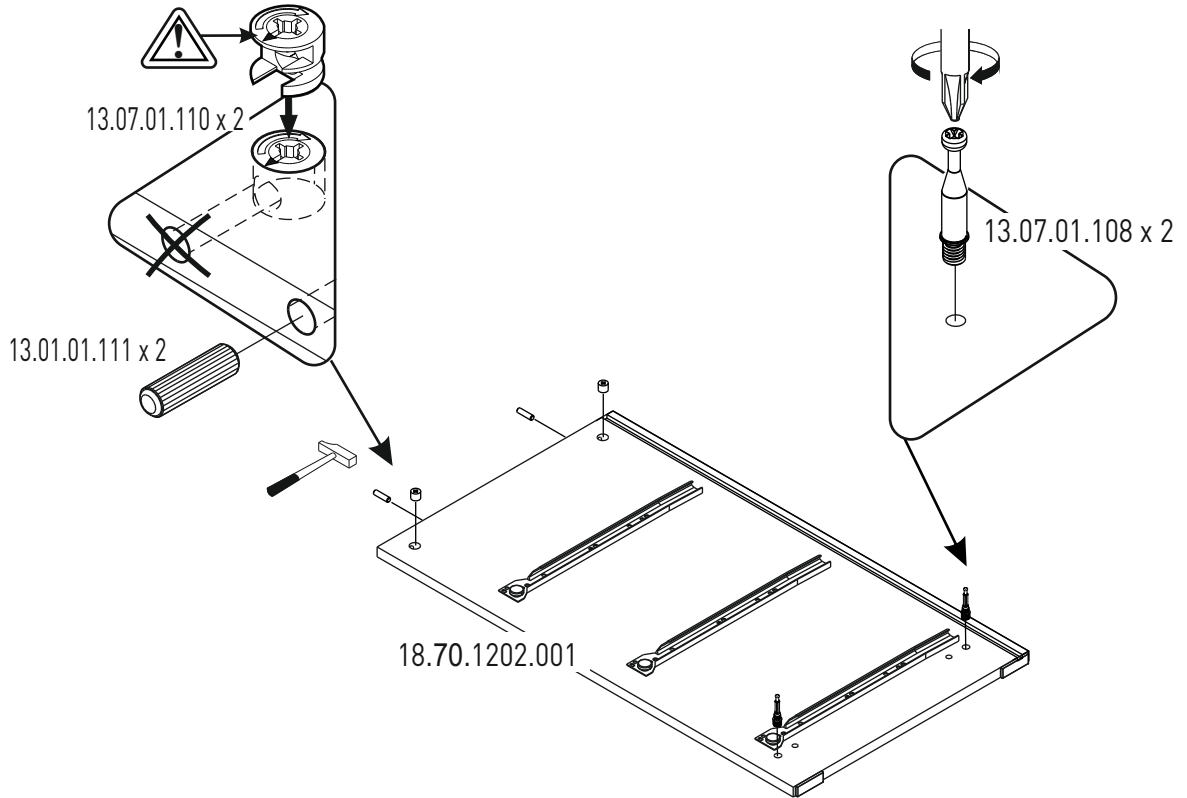

5

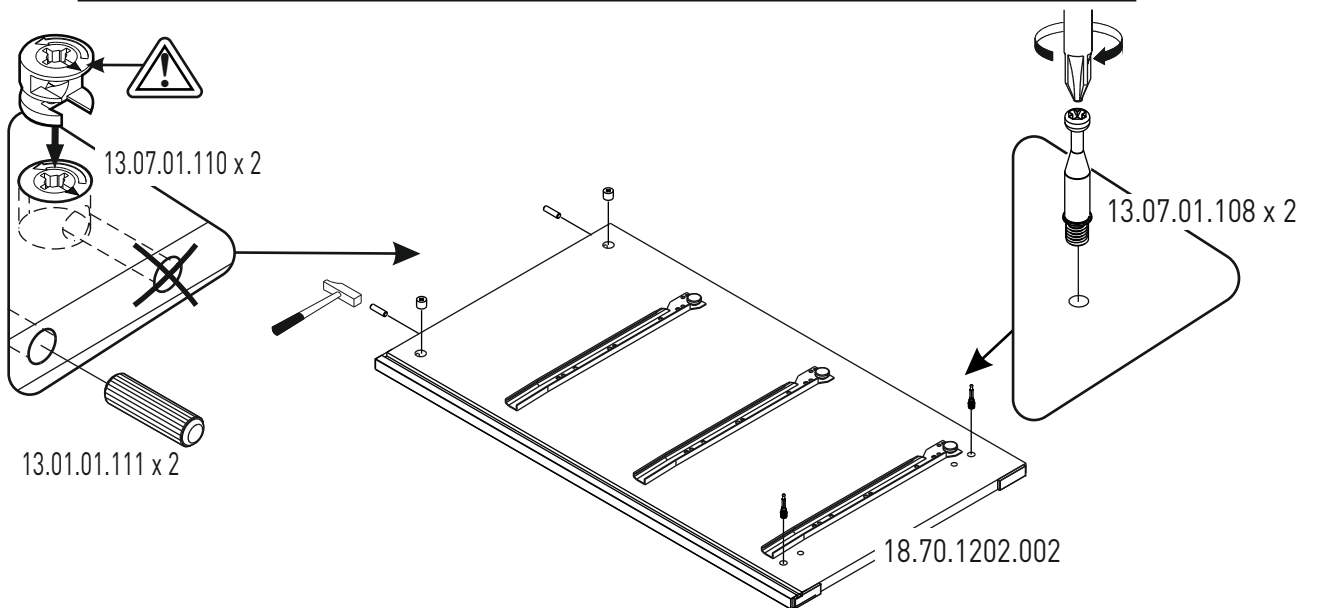

6

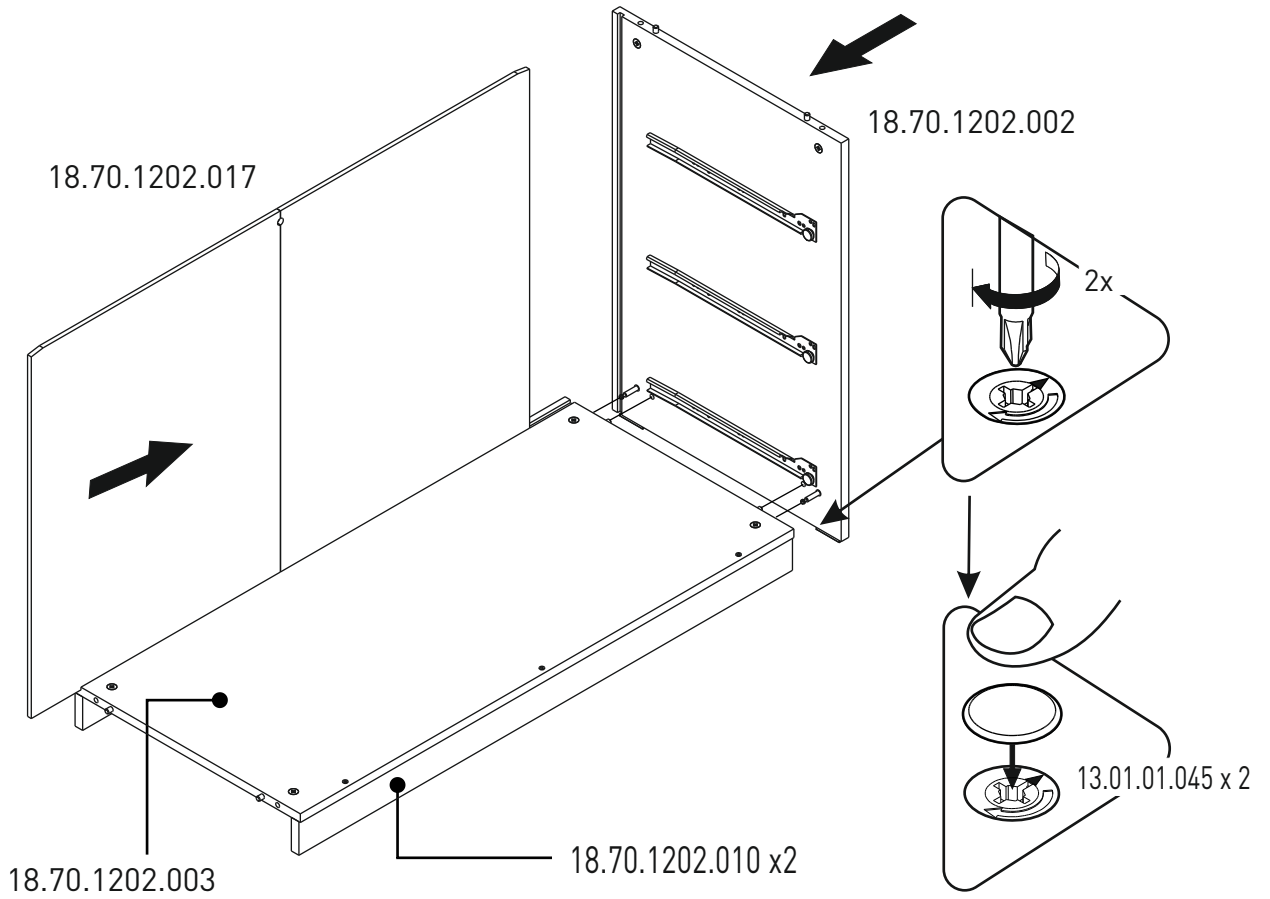

7

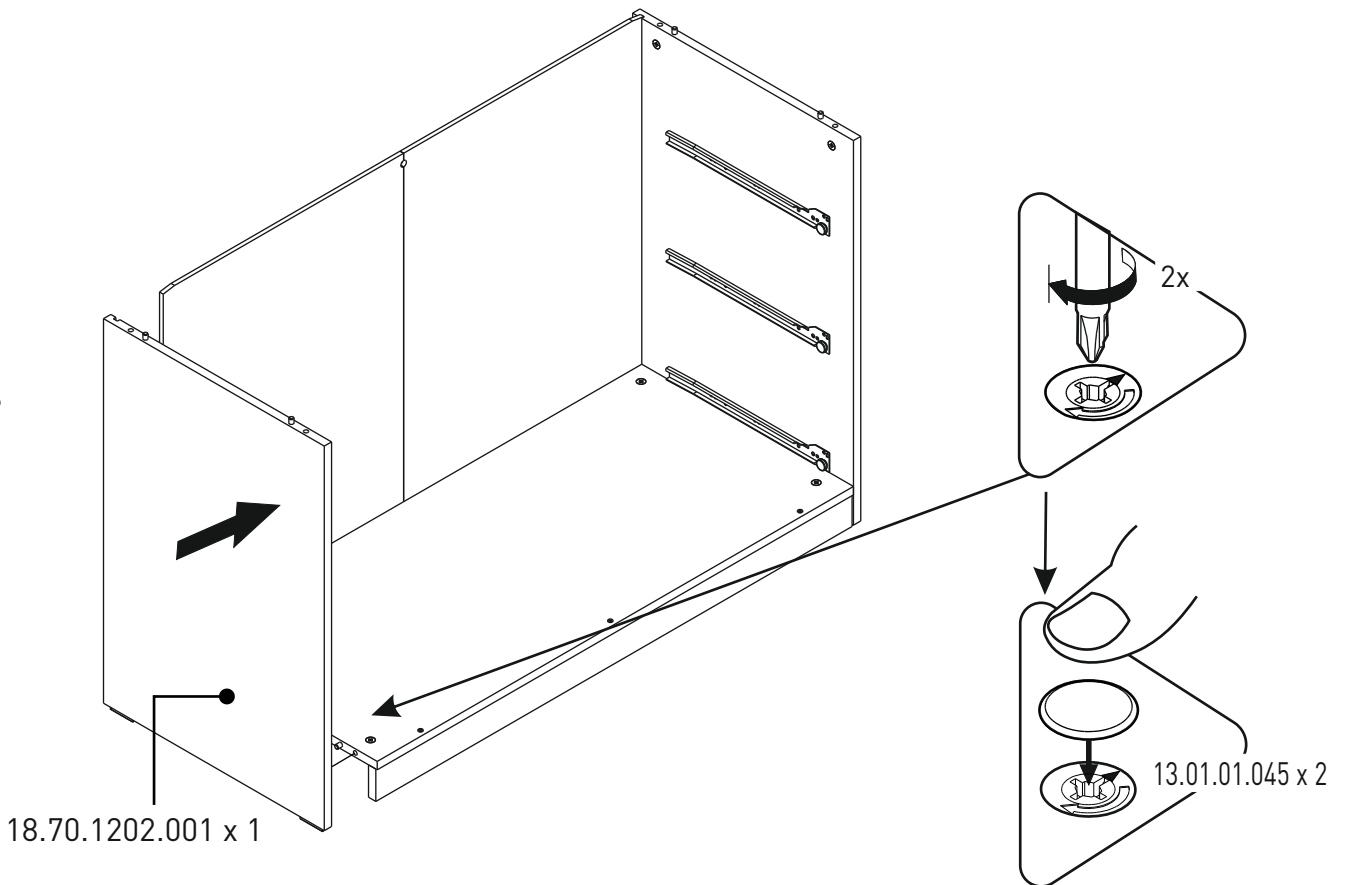

8

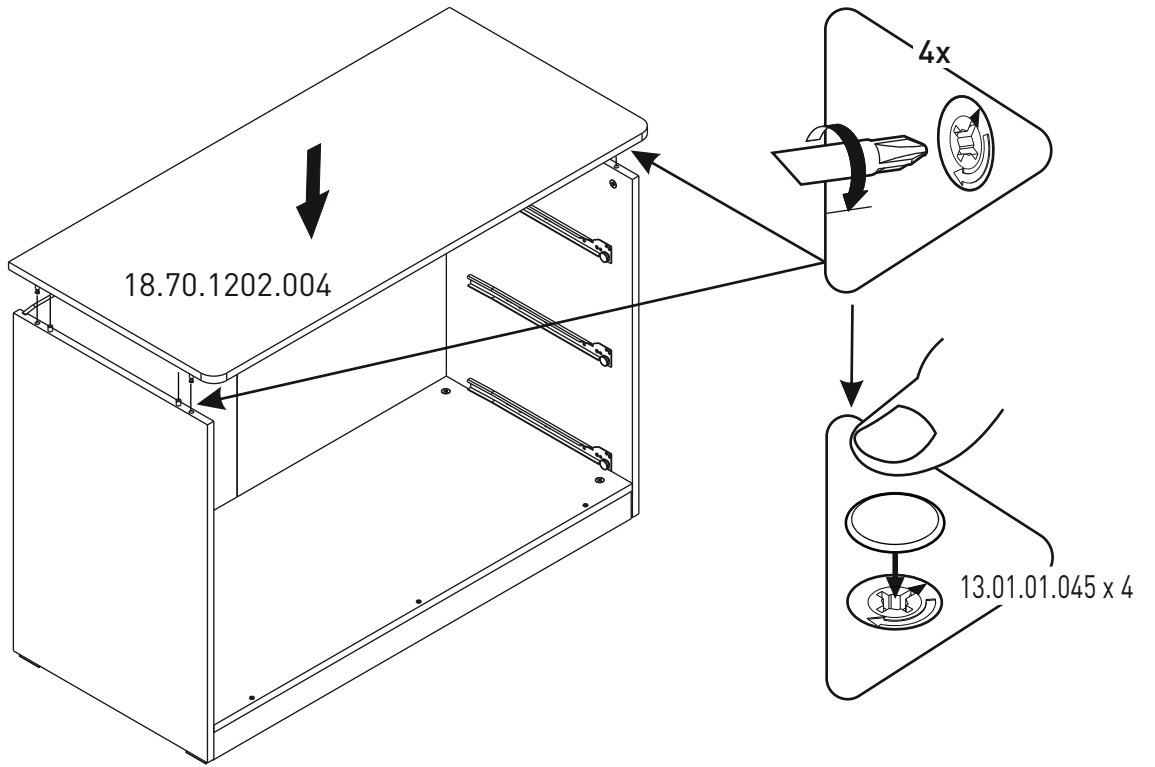

9

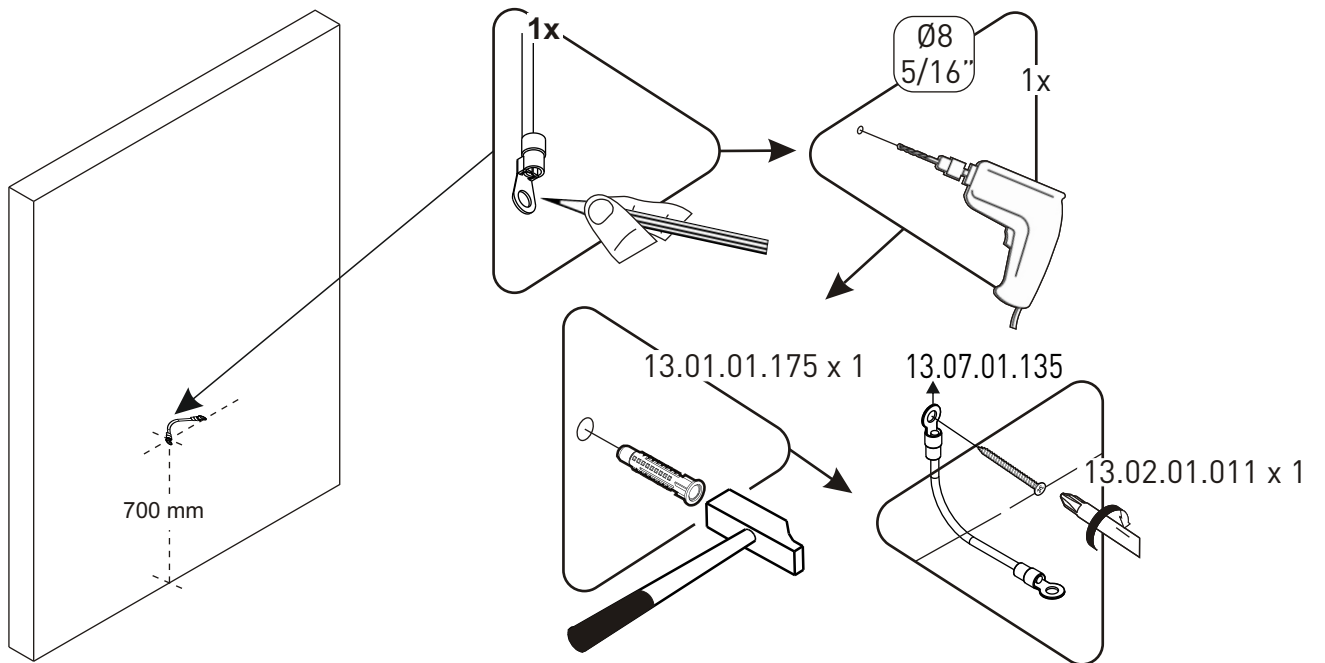

10

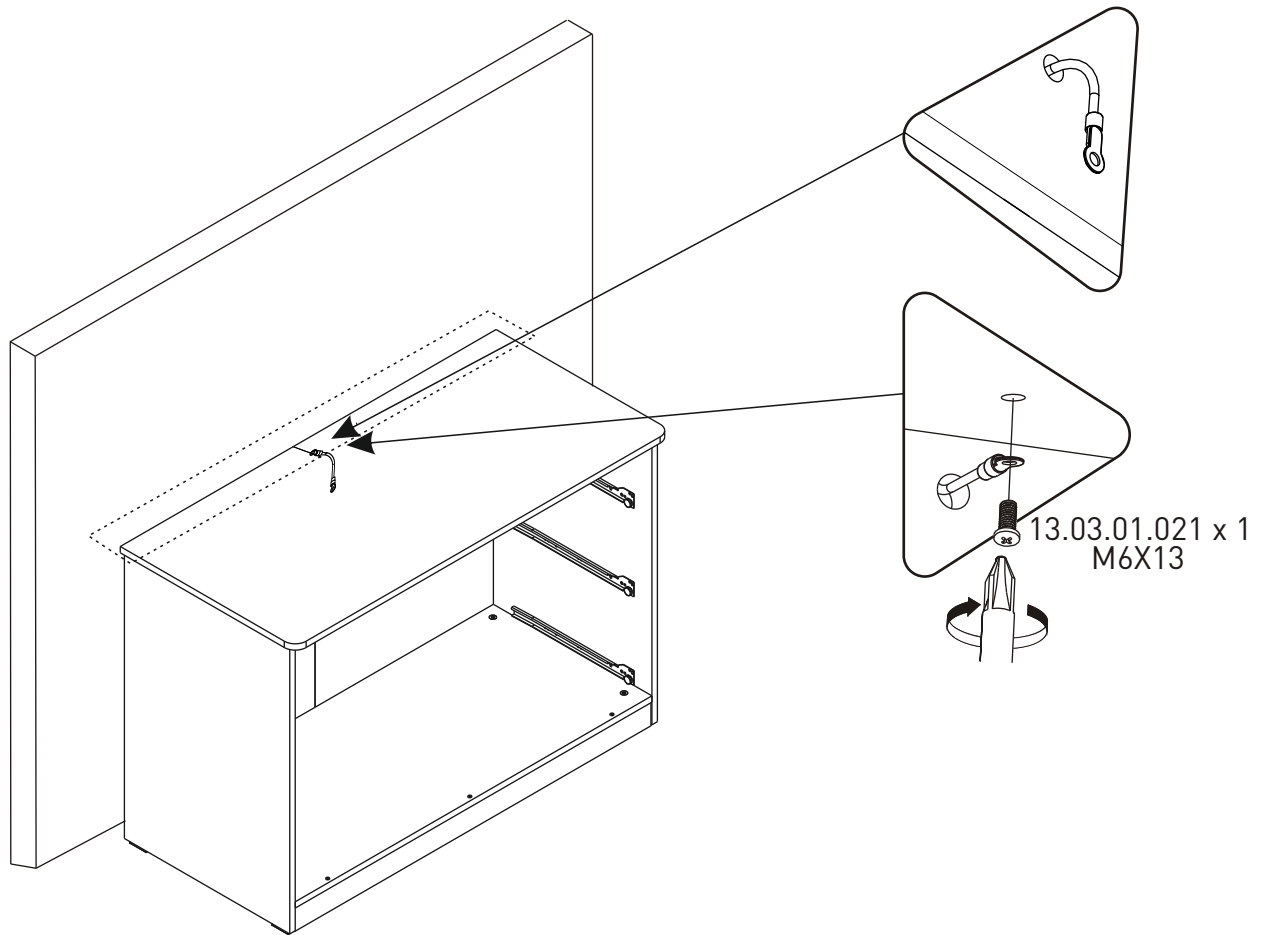

11

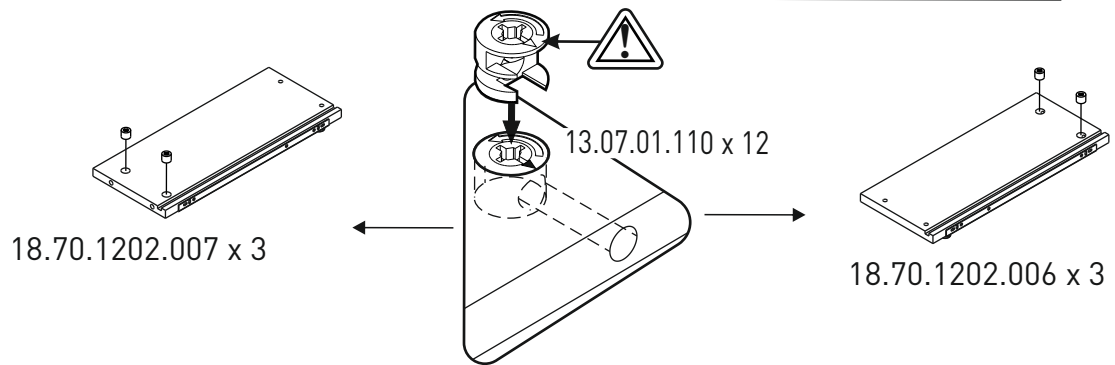

12

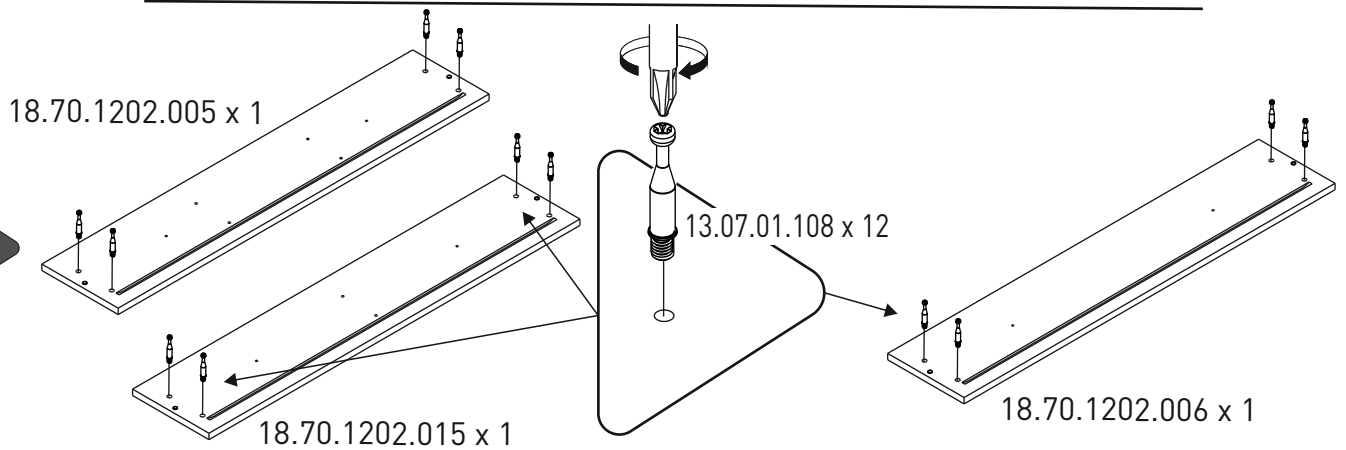

13

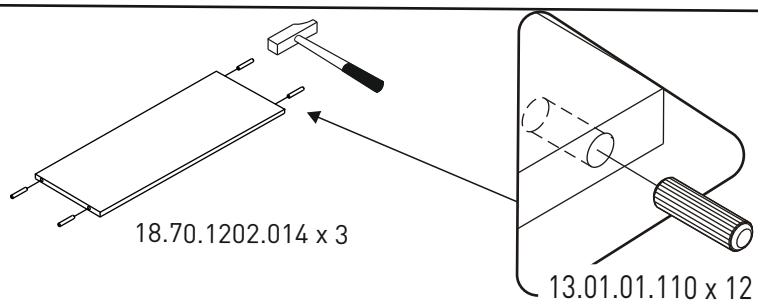

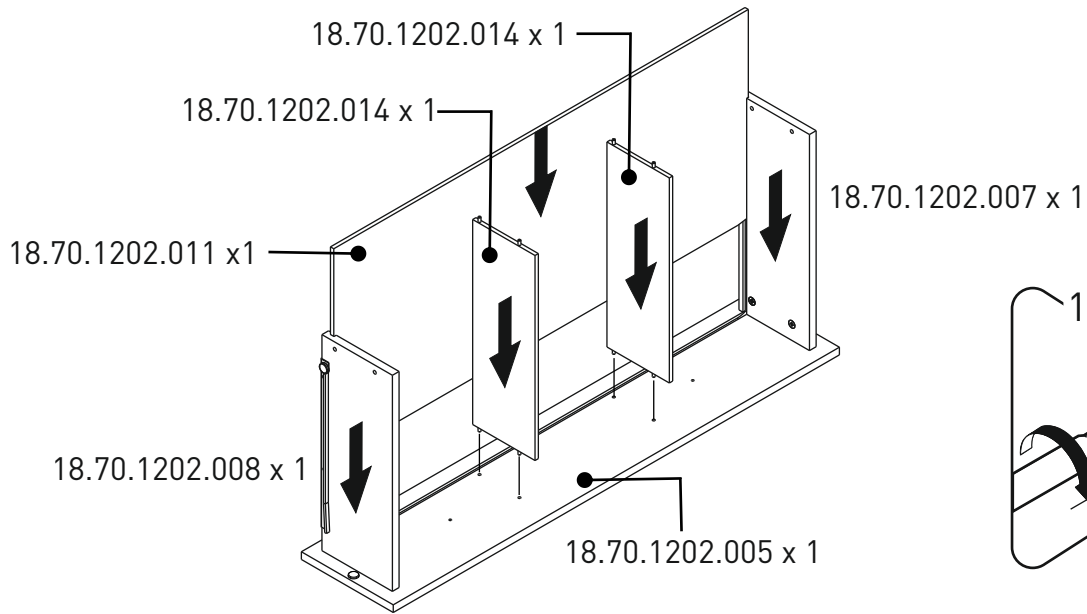

14

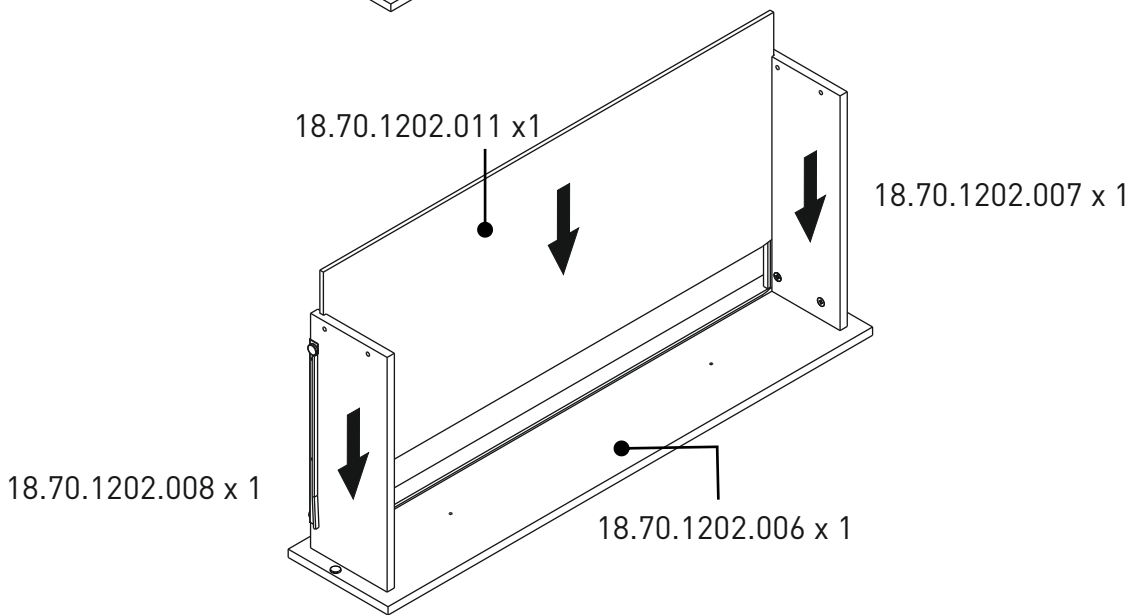
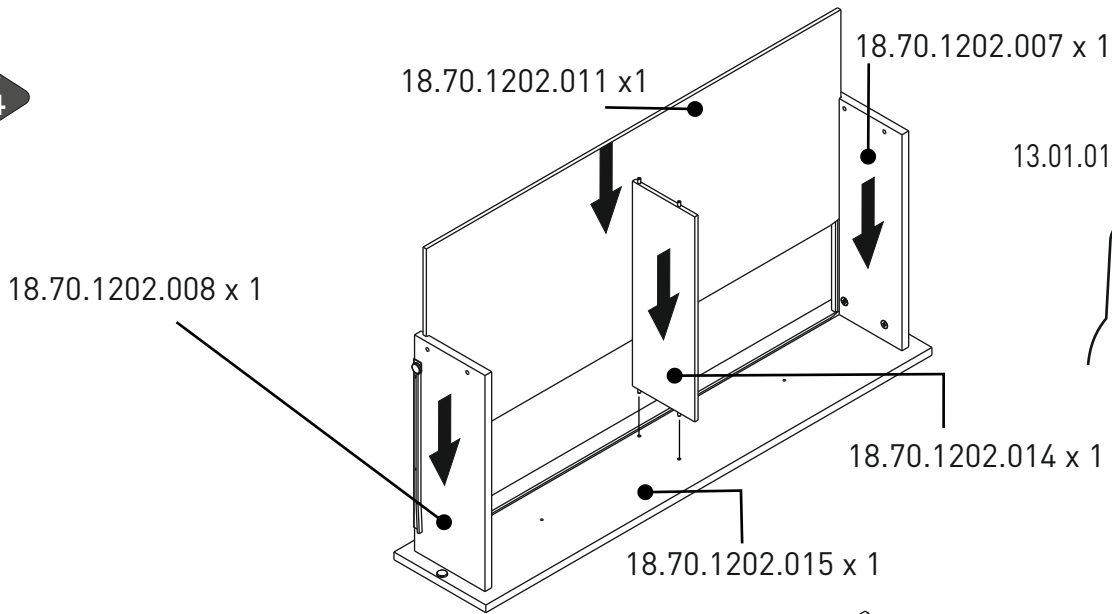



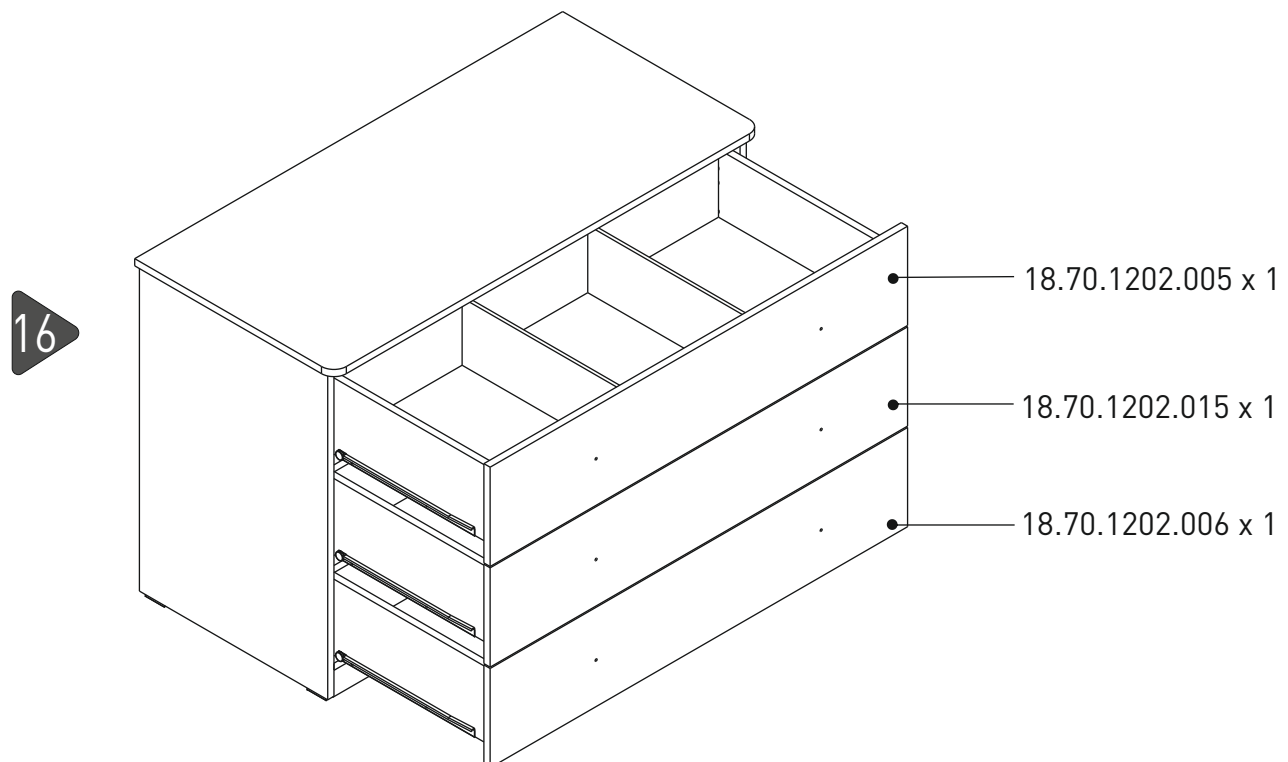
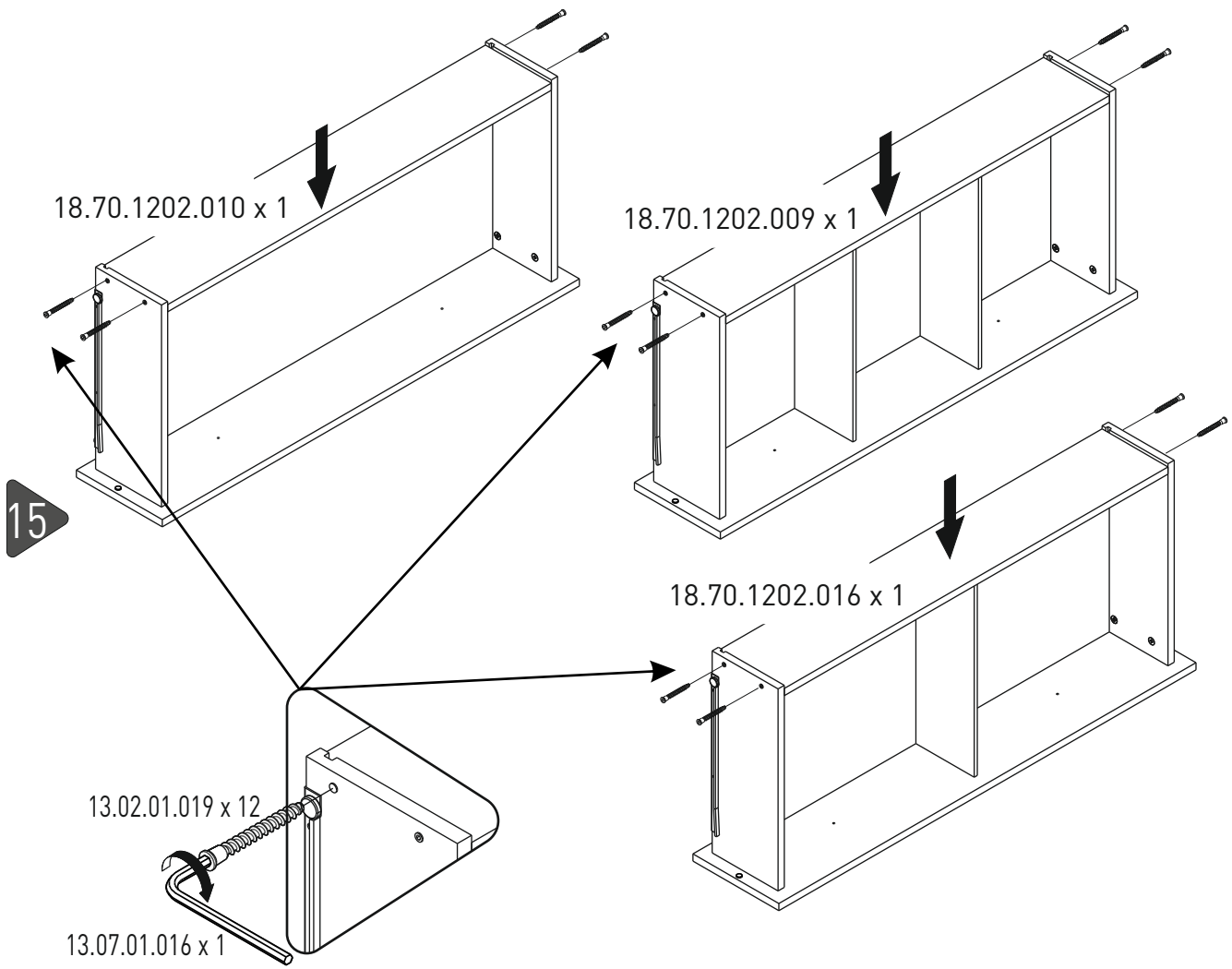

17

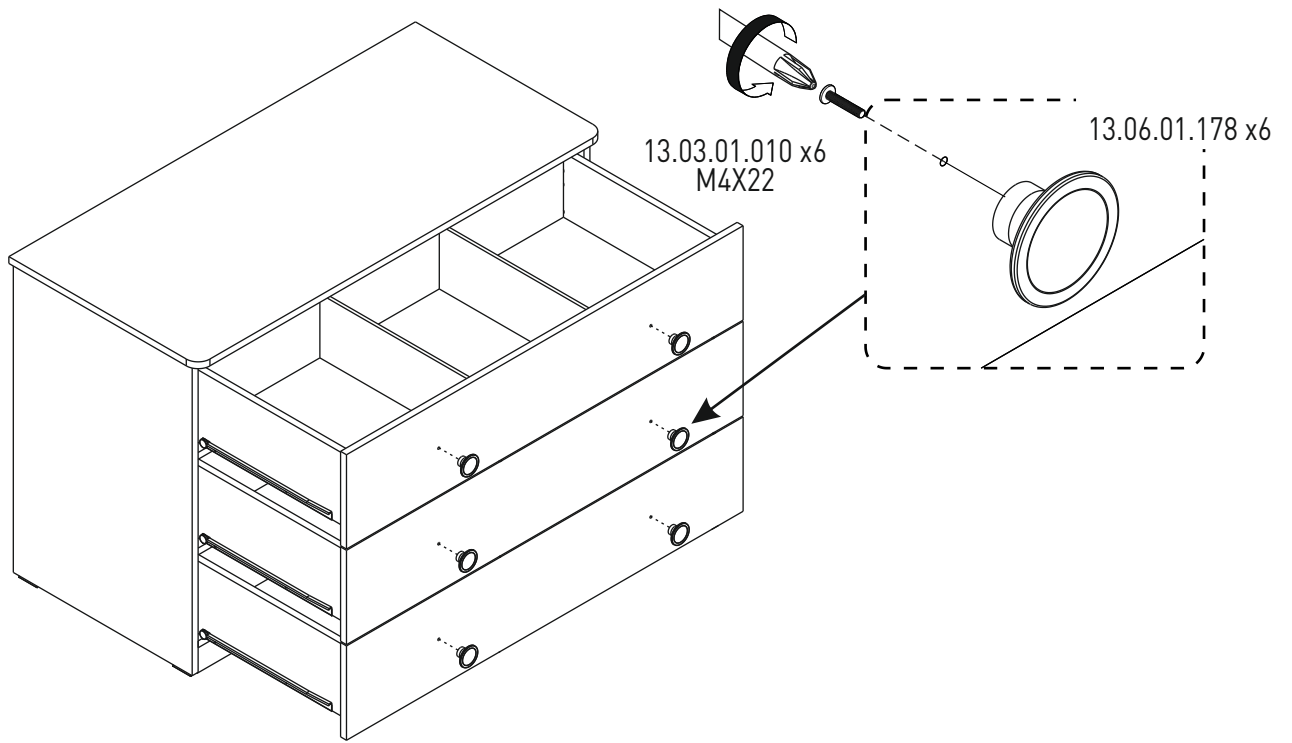

18

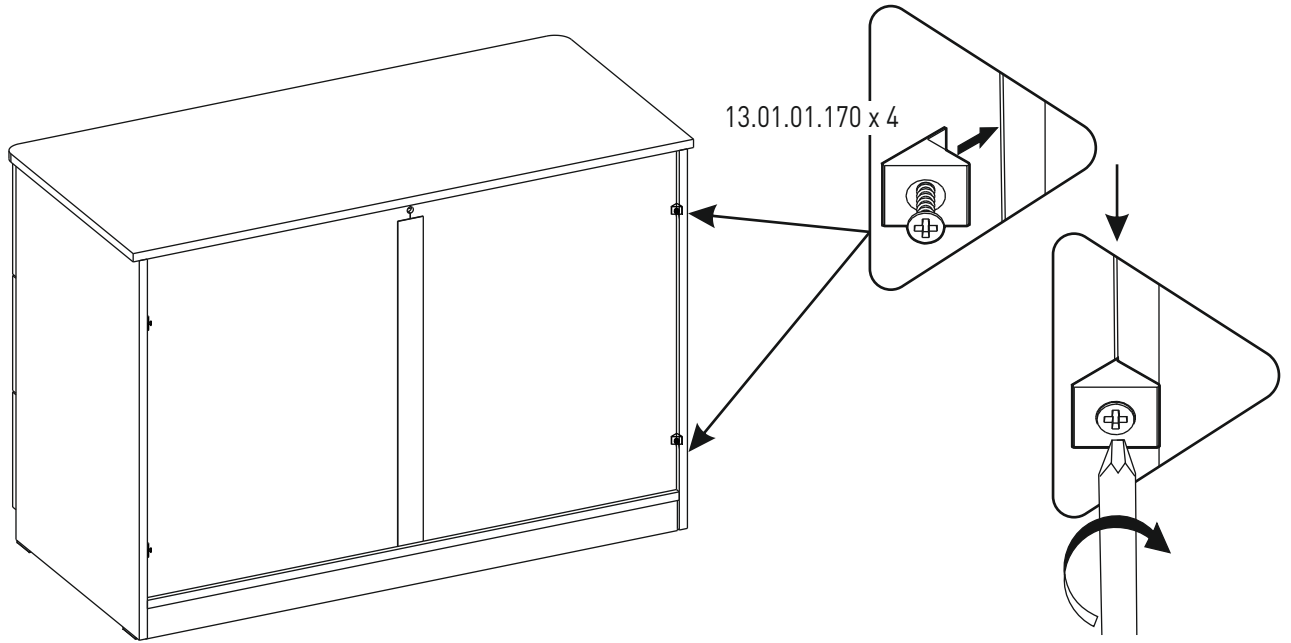

i

