

MY YOUR®

ITALIAN OUTDOOR EXPERIENCE

OVERVIEW

MY YOUR®

ITALIAN OUTDOOR EXPERIENCE

OVERVIEW

L'esperienza tutta italiana di MY YOUR fonde insieme design, tecnologia e professionalità per creare, arredare e vivere il proprio spazio esterno in modo eccellente, qualitativo e sensoriale. Benvenuti in "Italian Outdoor Experience", il nuovo corso aziendale di MY YOUR®.

The MY YOUR all-Italian experience combines design, technology and professionalism to create, furnish and live your outdoor space in an excellent, qualitative and multisensory way. Welcome to "Italian Outdoor Experience", the MY YOUR's new corporate course.





#### MY YOUR

- 10 Identità  
Identity
- 12 Valori e Sostenibilità  
Values and Sustainability
- 14 Progettisti  
Designers

#### MIMI

- 16 Tavoli da pranzo  
Dining tables
- 21 Tavoli contract  
Contract tables

#### MAJA

- 26 Tavoli da pranzo  
Dining tables
- 31 Tavoli contract  
Contract tables

#### SOFIA

- 34 Poltrona da pranzo  
Dining armchair

#### ADA

- 40 Sedie  
Chairs

#### TINA COLLECTION

- 46 Sedie e sgabelli  
Chairs and stools

**BETTY**

- 52 Lettini  
Sunbeds

**LOUIS**

- 60 Materassone galleggiante  
Floating lounge mattress

**IRIS COLLECTION**

- 68 Poltrona e sgabello  
Armchair and stool

- 73 Tavolino e tavolo  
Coffee table and table

**PSV**

- 76 Plastica seconda vita  
Second life plastic

**TECH SPECS**

- 78 Indice tecnico per collezioni  
Tech Index by collections

- 114 Panoramica dei materiali  
Materials overview





MY YOUR è una storia, una famiglia e un'azienda di design italiana.  
 MY YOUR si è evoluta, nel corso del tempo, trasformando e migliorando il proprio design e implementando le innovazioni tecnologiche di pari passo con la propria brand identity.  
 MY YOUR presenta oggi la sua nuova e consolidata identità di editore e produttore di arredi e complementi che aiutano a creare spazi dalla forte personalità, senza mai trascurarne l'eleganza della forma e l'eccellenza qualitativa.  
 MY YOUR diventa così un'esperienza di successo, interamente sviluppata e prodotta in Italia, sia come marchio, sia come linguaggio estetico e funzionale delle proprie collezioni outdoor.

MY YOUR is a story, a family and an Italian design company.  
 MY YOUR has evolved itself, over time, transforming and improving its design and implementing technological innovations alongside its brand identity.  
 Today MY YOUR introduces its new and consolidated corporate identity as editor and producer of furniture and accessories that help to create spaces with a strong personality, without neglecting its elegance of form and quality excellence.  
 MY YOUR thus becomes a successful experience, entirely developed and produced in Italy, both as a brand and as an aesthetic and functional language of its outdoor collections.



L'evoluzione di MY YOUR porta in sé i valori di **tradizione** della grande manifattura italiana, di **innovazione tecnologica** e di costante **ricerca** di materiali e soluzioni costruttive per proporre prodotti ergonomici, eleganti in grado di comunicare relax a prima vista. La **creatività** di ogni progetto è per MY YOUR il fondamento costruttivo per sviluppare e industrializzare l'impensabile, e per offrire stili diversi in grado di soddisfare il cliente con la sua ampia scelta.

La **sostenibilità** è un valore inscindibile dal concetto di outdoor. L'attenzione e la cura dei dettagli di MY YOUR rivolta a questo tema sta spingendo sempre di più verso un utilizzo dei materiali e di processi costruttivi che implementino in futuro un sistema di economia circolare, in grado di minimizzare l'impatto ambientale della produzione industriale, totalmente realizzata in azienda. Essere sostenibile per MY YOUR significa, pertanto, reinterpretare il concetto di design come espressione della forma in un contesto mondiale in cui l'ambiente necessita la priorità.

MY YOUR evolution brings in itself the values of the great Italian manufacture **tradition**, of the **technological innovation** and the constant **research** of materials and constructive solutions to offer ergonomic products, elegant able to communicate relaxation at first sight. The creativity of each project is for MY YOUR the constructive foundation to develop and industrialize the unthinkable, and to offer different styles able to satisfy the customer with its wide choice.

**Sustainability** is an inseparable value from the concept of outdoor. The MY YOUR attention, focused to this issue, is driving more and more towards the materials use and construction processes that will implement a system of circular economy in the future, able to minimize the environmental impact of the industrial production, completely made in the company. Being sustainable for MY YOUR means, therefore, reinterpreting the concept of design as expression of form in a world context where the environment needs priority.



**MORE DESIGN**

Mimi  
Maja

**MY YOUR R&D**

Betty  
Louis

**MARCO MARAN**

Iris collection

**MORE DESIGN**

E' una società padovana, fondata nel 2007, di industrial design, specializzata in ricerca, innovazione, engineering, industrializzazione e marketing intorno al prodotto, che garantisce il risultato finale secondo le aspettative del cliente. Lavora per aziende riconosciute sia in Italia che all'estero. More Design vince il premio A' Design Award/Gold con la collezione Push di MY YOUR nel 2022.

It is a industrial design company from Padua, founded in 2007, specialized in research, innovation, engineering, industrialization and product marketing, that guarantees the final result according to the customer expectations. It works for recognized companies both in Italy and abroad. More Design won the A' Design Award/Gold with the MY YOUR's Push Collection in 2022.



**MARCO MARAN**

Marco Maran è un designer nato a Siena nel 1963 e il suo lavoro nel campo del design è caratterizzato da un impegno costante nella ricerca, nella sintesi e nel perfezionamento delle sue idee. Collabora con diverse aziende di rilievo nel settore del design. Inoltre, ha ricevuto numerosi premi e riconoscimenti per molti dei suoi progetti nel corso degli anni, dimostrando la qualità e l'originalità del suo lavoro. Questi premi e riconoscimenti testimoniano la carriera di successo di Marco Maran nel campo del design e la sua capacità di creare progetti innovativi e di alta qualità.

Marco Maran is a designer born in Siena in 1963, and his work in the field of design is characterized by a constant commitment to research, synthesis, and refinement of his ideas. He collaborates with various prominent companies in the design industry. Additionally, he has received numerous awards and recognitions for many of his projects over the years, demonstrating the quality and originality of his work. These awards and recognitions attest to Marco Maran's successful career in the field of design and his ability to create innovative and high-quality projects.

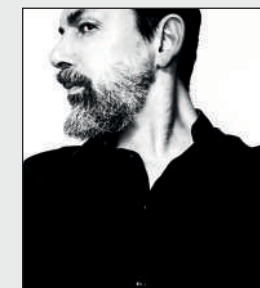



# MIMIÌ

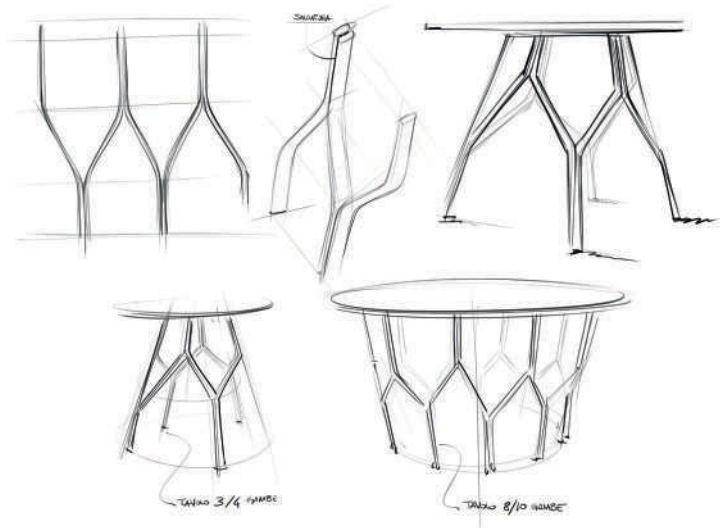

Design by - More Design





Mimi tavolo da pranzo, Sofia poltroncina da pranzo con cuscino  
 Mimi dining table, Sofia dining armchair with cushion



### Mimi

Un grande tavolo rotondo pensato per i momenti di condivisione: fino a dieci persone possono accomodarsi senza la formalità del capotavola. Il basamento impilabile in alluminio, completamente riciclabile, è costituito da un incrocio di tubi che creano un vortice di pieni e vuoti attraverso il quale filtra la luce, alleggerendo la percezione dell'ingombro. Il piano è disponibile in grès e HPL. Una combinazione di elementi per arredare la zona living all'aperto senza compromessi. Per gli ambienti meno spaziosi o per il settore contract sono disponibili i tavoli con 3 o 4 razze, con il piano tondo o quadrato.

A large round table designed for moments of sharing: up to ten people can sit without the formality of a head table. The stackable aluminium base, completely recyclable, is made of an intersection of tubes that create a vortex of solids and voids through which light filters, lightening the perception of volume. The top is available in stoneware and HPL. A combination of elements to furnish the outdoor living area without compromises. For smaller spaces or the contract sector, tables with 3 or 4 spokes are available, with a round or square tabletop.



Mimi tavoli contract 3 razze con piano 79x79, Sofia poltroncina da pranzo  
Mimi 3 spokes contract table with 79x79 top, Sofia dining armchairs



Mimi tavolo contract 3 razze con piano Ø69. Sofia poltroncina da pranzo  
Mimi 3 spokes contract table with Ø69 top. Sofia dining armchair

# MAJA

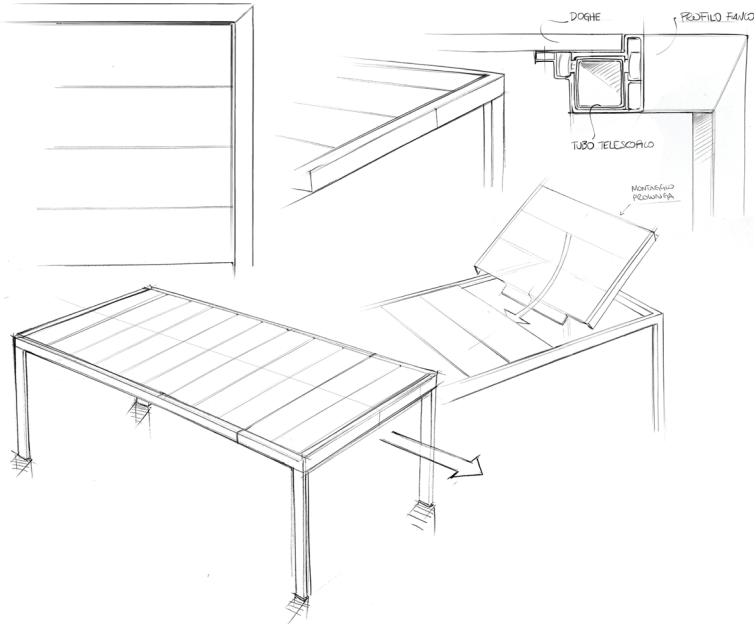

Design by More Design





Maja tavolo da pranzo, Ada sedie con braccioli  
Maja dining table, Ada chairs with armrests

## Maja

Maja è il nuovo tavolo MY YOUR progettato per rispondere ad un'esigenza crescente nel mercato outdoor: un connubio perfetto di design, leggerezza e resistenza. Il design è caratterizzato da una composizione di volumi regolari che puntano al rigore e alla simmetria, rimuovendo qualsiasi elemento decorativo e conferendo al tavolo un carattere forte. La funzionalità è messa al pari dell'eleganza, con un'attenzione maniacale verso i punti di giunzione dei vari componenti, ricercando un equilibrio tra la sintesi della forma e la praticità d'utilizzo. La scelta di utilizzare un materiale come l'alluminio, oltre a sottolineare un approccio eco friendly, rende il tavolo Maja leggero, ideale per momenti di convivialità e ritrovo all'aperto. Disponibile anche con il piano in HPL e in gres, e nella versione da pranzo o contract.

Maja is the new MY YOUR table designed to meet a growing need in the outdoor market: a perfect combination of design, lightness and strength. The design is characterized by a composition of regular volumes that aim at rigor and symmetry, removing any decorative element and giving the table a strong character. Functionality is put on a par with elegance, with maniacal attention paid to the joining points of the various components, seeking a balance between the synthesis of form and practicality of use. The decision to use a material such as aluminum, in addition to emphasizing an eco-friendly approach, makes the Maja table light, ideal for moments of conviviality and outdoor gatherings. Available also with HPL and stoneware top, and in the dining or contract version.







Maja tavolo da pranzo, Ada sedie con braccioli  
Maja dining table, Ada chairs with armrests

# SOFIA

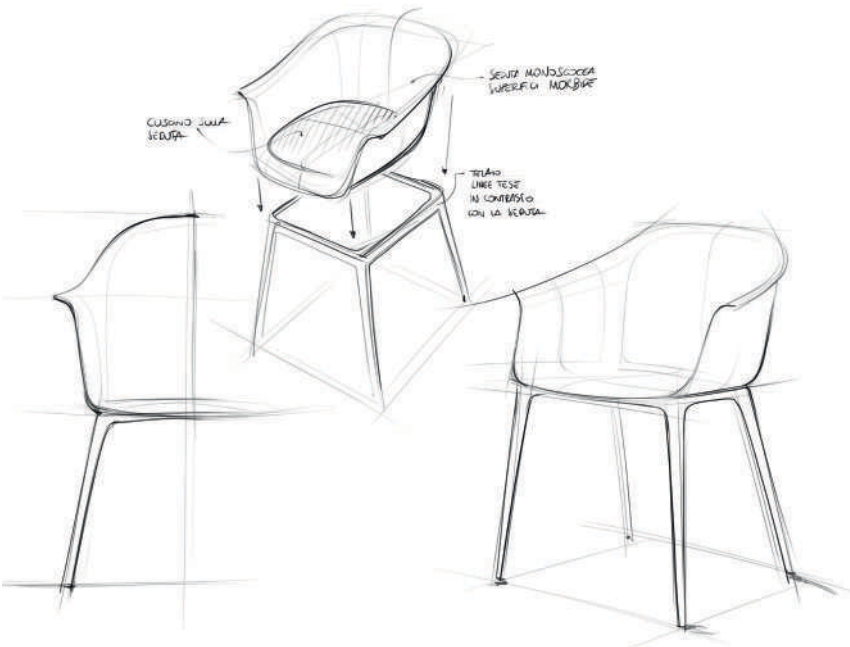

## Sofia

La poltroncina Sofia è realizzata in polipropilene di alta qualità. La sua versatilità la rende una scelta perfetta sia per ambienti contract che per spazi residenziali, offrendo comfort e stile ineguagliabili. Con la disponibilità di diversi colori, sia in versione monocolore che con gambe slegate cromaticamente alla seduta, Sofia permette una personalizzazione totale, adattandosi facilmente a qualsiasi estetica (ambiente). Il suo design lineare e pulito conferisce un tocco di eleganza senza tempo, mentre il materiale resistente ne garantisce una durata eccezionale. La combinazione di funzionalità, estetica e qualità "Made in Italy" fa di Sofia una scelta eccellente per chi cerca una poltroncina che unisca design raffinato e praticità.

Sofia armchair is made from high-quality polypropylene. Its versatility makes it a perfect choice for both contract environments and residential spaces, offering unmatched comfort and style. With a variety of color options available, including solid colors and legs that can match or contrast with the seat, Sofia allows for complete customization, easily adapting to any environment. Its clean and linear design adds a timeless touch of elegance, while its durable material ensures exceptional longevity. The combination of functionality, aesthetics, and "Made in Italy" quality makes Sofia an excellent choice for those seeking an armchair that combines refined design and practicality.





Sofia poltroncine con cuscino, Mimi tavolo contract 4 razze  
Sofia armchairs with cushion, Mimi 4 spokes contract table

# ADA



### Ada

La sedia Ada con la sua silhouette lineare e pulita, è stata progettata con l'intenzione di integrarsi armoniosamente sia negli spazi contract che in quelli residenziali. Il "Made in Italy" è sinonimo di eccellenza e la sedia ADA incarna questa tradizione artigianale italiana con maestria sia nella versione con braccioli che senza.

La sua impilabilità la rende una scelta pratica per ottimizzare lo spazio, consentendo di conservare facilmente multiple sedie quando non sono in uso. La sedia Ada, inoltre, è estremamente versatile grazie alla disponibilità di cinque colori. Questa varietà consente di personalizzare la sedia per abbinarla o contrastarla con l'ambiente circostante, aggiungendo un tocco di stile e vitalità a qualsiasi spazio in cui viene collocata. Ada rappresenta quindi un connubio perfetto tra design, funzionalità e qualità italiana, che si adatta a ogni esigenza e ambiente.

Ada chair, with its clean and linear silhouette, has been designed with the intention of seamlessly integrating into both contract and residential spaces. "Made in Italy" is synonymous with excellence, and the Ada chair embodies this Italian craftsmanship tradition masterfully, both in the version with armrests and without. Its stackability makes it a practical choice for space optimization, allowing for easy storage of multiple chairs when not in use. The Ada chair is also extremely versatile, thanks to the availability of five colors. This variety allows for personalization to either match or contrast with the surrounding environment, adding a touch of style and vibrancy to any space it is placed in. Ada represents a perfect blend of design, functionality, and Italian quality that adapts to any need and environment.





Ada sedie con braccioli, Levante tavolo da pranzo (catalogo Extraordinary)  
Ada chairs with armrests, Levante dining table (Extraordinary catalogue)

# TINA

COLLECTION





### Tina collection

La sedia Tina è un esempio di design semplice ed elegante, realizzata in polipropilene e disponibile in diversi colori. Questa sedia è pensata per adattarsi con versatilità a diverse situazioni: è disponibile sia con che senza braccioli. Le sue linee pulite e semplici conferiscono un tocco di modernità e raffinatezza a qualsiasi ambiente in cui viene collocata. Grazie alla sua robustezza e al suo design senza tempo, la sedia Tina è una scelta versatile e pratica per chi cerca comfort e stile in una sola soluzione.

Nella collezione Tina è disponibile lo sgabello, che si aggiunge alla versatilità di questa linea di arredamento.

Tina chair is an example of simple and elegant design, made of polypropylene and available in various colors. This chair is designed to adapt with versatility to different situations and is available with or without armrests. Its clean and simple lines add a touch of modernity and sophistication to any environment it is placed in. Thanks to its robustness and timeless design, the Tina chair is a versatile and practical choice for those seeking both comfort and style in one solution.

In the Tina Collection, there is also a stool available, adding to the versatility of this furniture line.





Tina sedie con braccioli, tavolo da pranzo Teddy (catalogo Open-Air)  
Tina chairs with armrests, Teddy dining table (Open-Air catalogue)

# BETTY

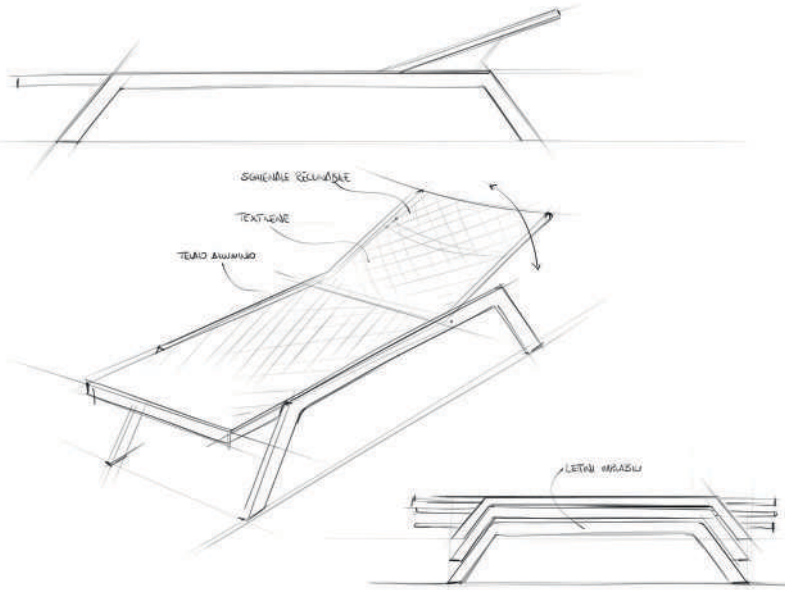

Design by MY YOUR





## Betty

Semplicità è la parola chiave che descrive Betty, il lettino ideale sia alle installazioni contract sia ai progetti residenziali. La linea essenziale e lineare dà forma ad un design semplice e incredibilmente delicato.

La struttura in alluminio conferisce leggerezza al lettino, rendendolo facilmente trasportabile da un ambiente all'altro. L'opzione delle ruote aggiunge ulteriore praticità, permettendo di spostare agevolmente il lettino per adattarlo alle diverse esigenze dell'ambiente.

Betty è un esempio di design intelligente che si sposa perfettamente con la funzionalità. La sua semplicità visiva nasconde una grande attenzione ai dettagli e alla comodità, garantendo un luogo di riposo raffinato e confortevole. Sia che lo si utilizzi per rilassarsi al bordo piscina in un hotel di lusso o per prendere il sole nel proprio giardino, Betty offre un mix equilibrato di stile e praticità che soddisferà anche i gusti più esigenti.

"Simplicity" is the key word that describes Betty, the ideal sun lounger for both contract installations and residential projects. Its essential and linear design shapes a simple and incredibly delicate look.

The aluminum frame gives the lounger a lightweight quality, making it easily portable from one space to another. The option of adding wheels provides additional convenience, allowing for easy adjustment of the lounger to suit different environment needs.

Betty is an example of intelligent design that perfectly combines functionality. Its visual simplicity hides a great attention to detail and comfort, ensuring a refined and comfortable place to rest. Whether used for lounging by the pool at a luxury hotel or for sunbathing in your own garden, Betty offers a balanced mix of style and practicality that will satisfy even the most discerning tastes.





Betty lettini, Iris tavolini e poltrone  
Betty sunbeds, Iris coffee tables and armchairs

# LOUIS

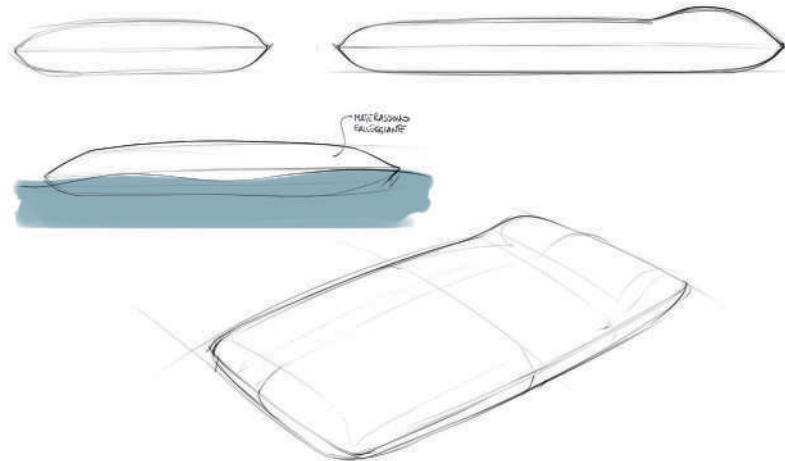

Design by MY YOUR

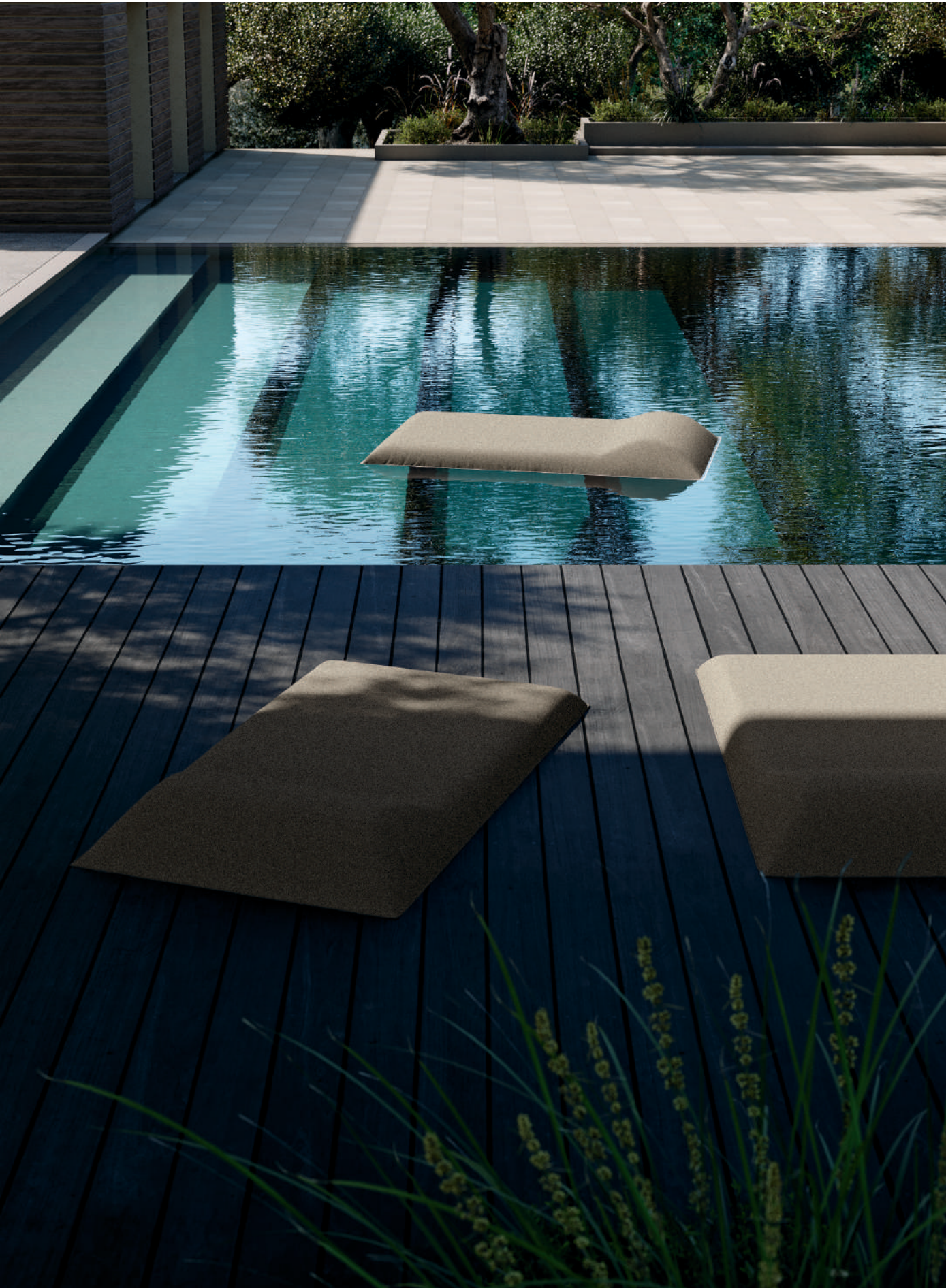

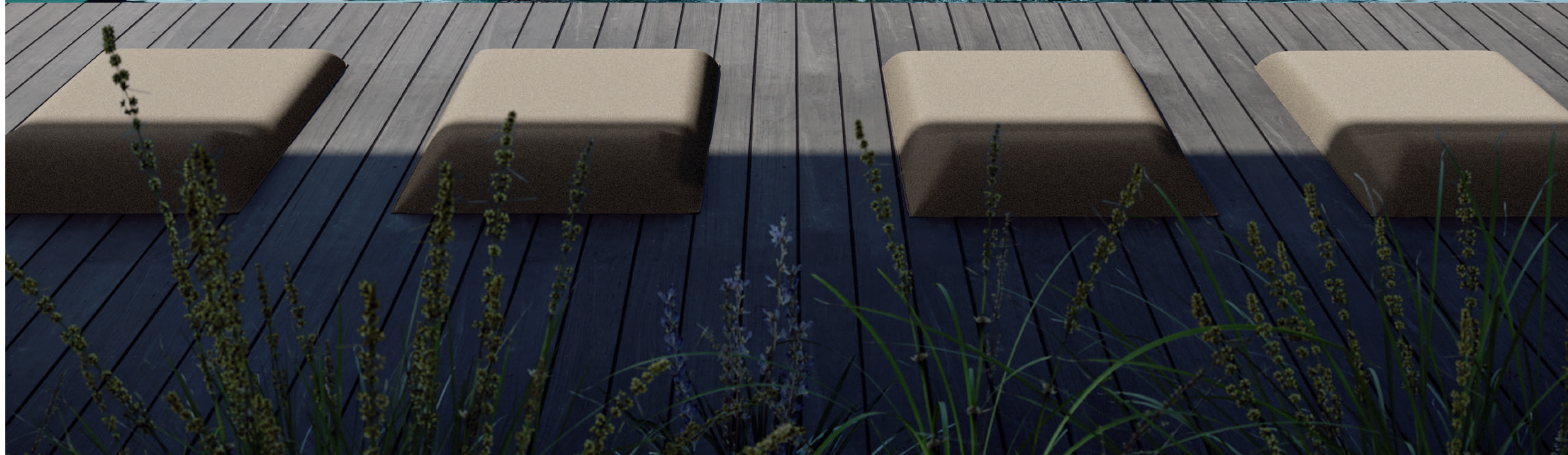

Louis materassoni galleggianti  
Louis floating lounge mattresses



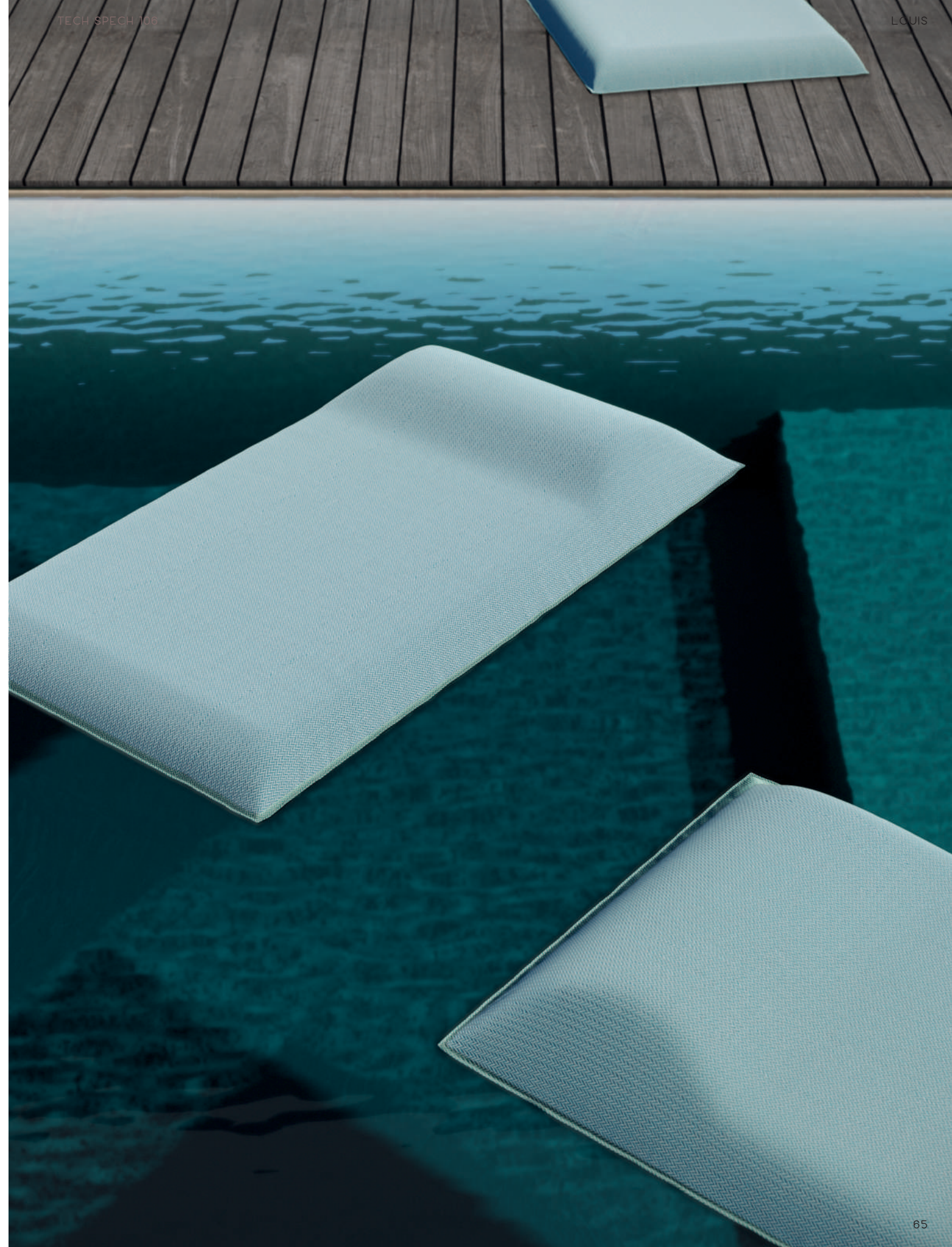

## Louis

Louis è il nuovo materassone galleggiante, frutto di una ricerca che mette il comfort al centro dell'esperienza dell'utente, in ogni momento trascorso all'aperto. Questo materassone, dall'estetica lineare e dalla struttura rigida, è stato progettato per garantire una più facile risalita dall'acqua e far sentire sempre al sicuro godendo a pieno la leggerezza dello specchio d'acqua e il calore del sole.

Per un'esperienza di relax in perfetta armonia con la natura, Louis è disponibile in quattro colori esclusivi: l'azzurro, che ricorda il colore del mare, lo juta, ispirato al calore della sabbia e per riprendere le tonalità delle spiagge bianche e soffici, il giallo del sole e l'arancio, una delle spettacolari nuances offerte dal tramonto all'imbrunire. Con il suo aspetto ricercato, le doti funzionali e la qualità di una manifattura Made in Italy, Louis è il materassone di design che non esisteva e che completa con stile il set d'arredamento outdoor.

Louis is the new floating mattress, the result of research that places comfort at the center of the user's outdoor experience at all times. This mattress, with its linear aesthetics and rigid structure, has been designed to ensure easier ascent from the water and always make you feel secure while fully enjoying the lightness of the water's surface and the warmth of the sun. For a relaxation experience in perfect harmony with nature, Louis is available in four exclusive colors: blue, reminiscent of the color of the sea; juta, inspired by the warmth of the sand and the soft, white beach tones; yellow, like the sun; and orange, one of the spectacular hues offered by the sunset to twilight. With its refined appearance, functional qualities, and the quality of Italian craftsmanship, Louis is the design mattress that didn't exist before and stylishly complements your outdoor furniture set.



Louis materassone galleggiante, Iris poltrone e tavolini  
Louis floating lounge mattress, Iris armchairs and coffee tables

# IRIS

COLLECTION

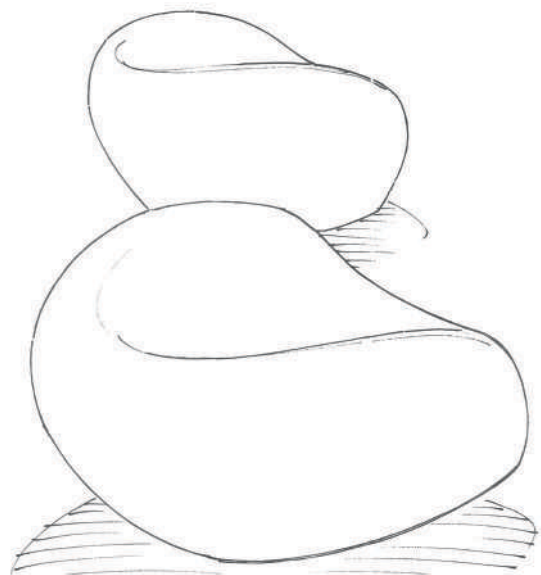

Design by Marco Maran





Iris poltrone e tavolini  
Iris armchairs and coffee tables



### Iris Collection

La caratteristica distintiva della collezione Iris è senza dubbio il suo design composto da linee curve e morbide. Queste forme sinuose conferiscono agli elementi della collezione un aspetto accogliente, che li rende perfetti per aggiungere un tocco di eleganza e comfort nelle diverse location. La collezione è composta da poltrona, coffee table, sgabello e tavolo. La combinazione di design accattivante e materiali di alta qualità la rende una scelta ideale per coloro che cercano un arredamento che unisca bellezza, funzionalità e l'etichetta "Made in Italy".

The distinctive feature of the Iris Collection is undoubtedly its design characterized by curved and soft lines. These sinuous shapes give the elements of the collection a welcoming appearance, making them perfect for adding a touch of elegance and comfort to various settings. The collection includes an armchair, coffee table, stool, and table. The combination of captivating design and high-quality materials makes it an ideal choice for those seeking furniture that combines beauty, functionality, and the "Made in Italy" label.



Iris poltrone e tavolini  
Iris armchairs and coffee tables



**Plastica seconda vita**  
Second life plastic

MY YOUR si impegna a rispettare l'ambiente e utilizza il marchio "plastica seconda vita" per presentare il salotto Nova realizzato con materiali riciclati nella finitura gofrata nel colore nero e nella finitura velvet nel colore antracite. Questo dimostra un forte impegno per la sostenibilità e la riduzione dell'impatto ambientale. L'uso di plastica riciclata aiuta a ridurre la dipendenza dalla plastica vergine e a contribuire al riciclo e al riutilizzo dei materiali. Il polietilene riciclato rappresenta una soluzione ecologica che contribuisce a ridurre la quantità di plastica vergine necessaria per la produzione, riducendo così l'impatto ambientale. La finitura "velvet" aggiunge un tocco di eleganza e comfort al design del salotto, rendendolo attraente sia esteticamente che dal punto di vista tattile. Questo tipo di approccio mostra come MY YOUR possa adattarsi e rispondere alle sfide ambientali contemporanee, promuovendo la sostenibilità senza sacrificare la qualità o l'estetica dei prodotti. La combinazione di design di alta qualità e materiali sostenibili è un passo importante verso un futuro più verde e responsabile dal punto di vista ambientale.

MY YOUR is committed to respecting the environment and uses the "plastica seconda vita" (second-life plastic) label to present the Nova lounge set made from recycled materials in matt finishing in black color and in the velvet finishing in anthracite color. This demonstrates a strong commitment to sustainability and reducing environmental impact. The use of recycled plastic helps reduce dependence on virgin plastic and contribute to the recycling and reuse of materials. Recycled polyethylene is an environmentally friendly solution that helps reduce the amount of virgin plastic needed for production, thereby reducing the environmental impact. The 'velvet' finish adds a touch of elegance and comfort to the lounge set design, making it attractive both aesthetically and tactilely. This approach shows how MY YOUR can adapt and respond to contemporary environmental challenges, promoting sustainability without sacrificing product quality or aesthetics. The combination of high quality design and sustainable materials is an important step towards a greener and environmentally responsible future.

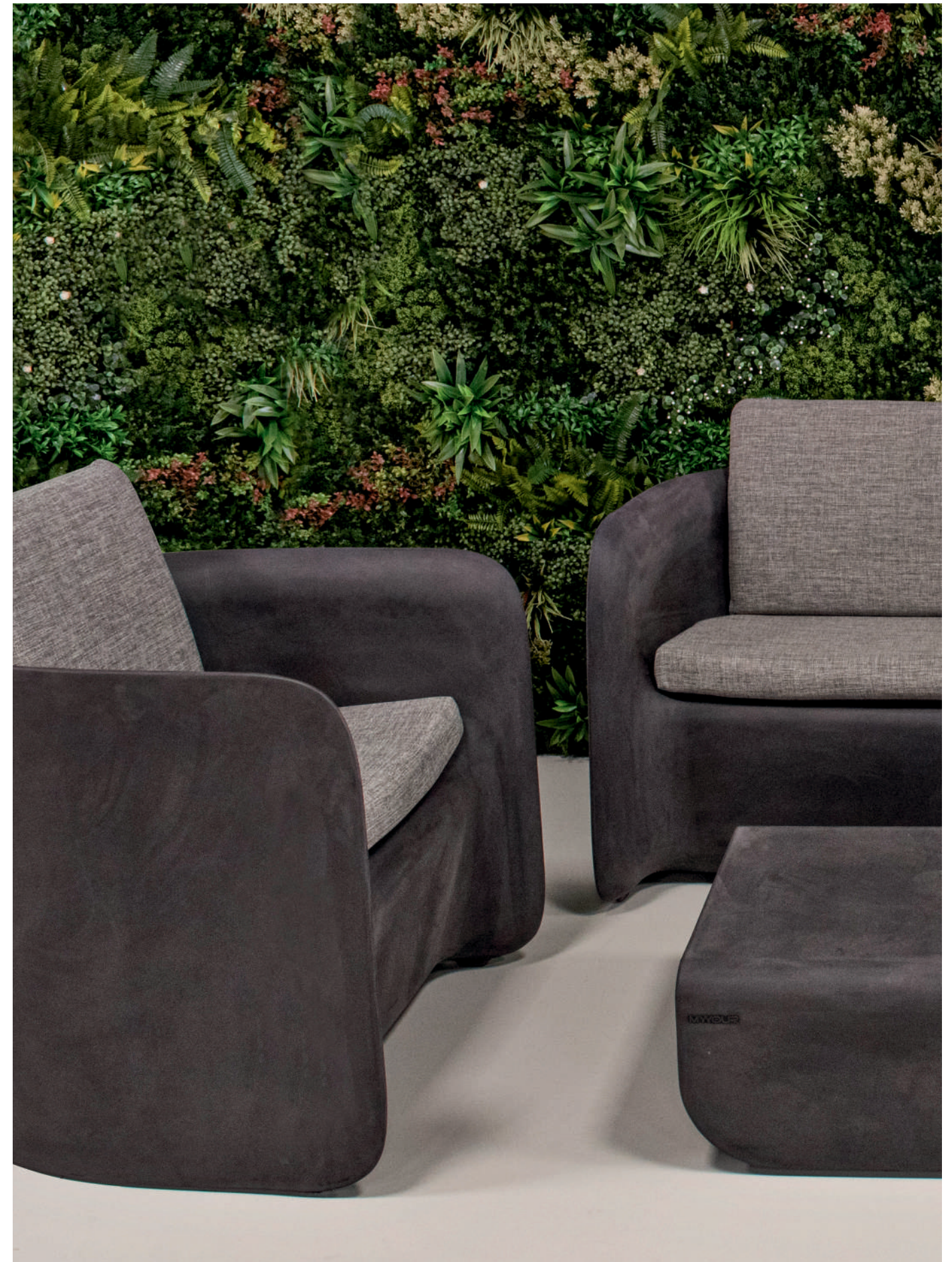

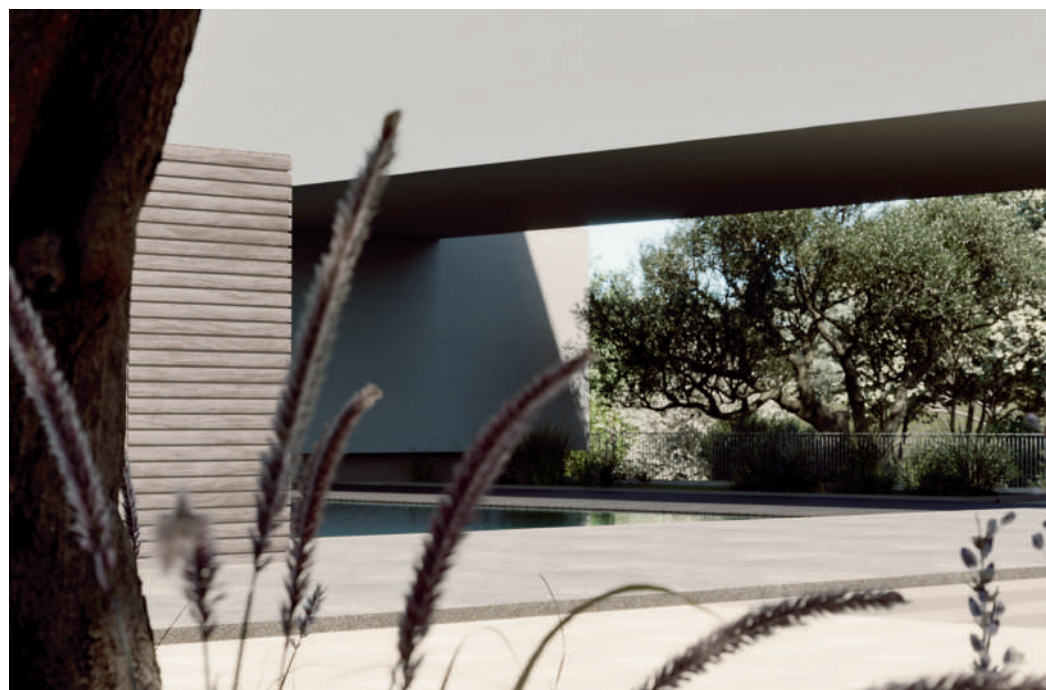
**MIMI**

80 Tavoli da pranzo  
Dining tables

80 Tavoli contract  
Contract tables

**MAJA**

86 Tavoli da pranzo  
Dining tables

86 Tavoli contract  
Contract tables

**SOFIA**

90 Poltrona da pranzo  
Dining armchair

**ADA**

94 Sedie  
Chairs

**TINA COLLECTION**

98 Sedie e sgabelli  
Chairs and stools

**BETTY**

102 Lettini  
Sunbeds

**LOUIS**

106 Materassone galleggiante  
Floating lounge mattress

**IRIS COLLECTION**

110 Poltrona, sgabello  
Armchair, stool

110 Tavolino e tavolo,  
coffe table and table





## Mimi

La collezione Mimi è composta da tavoli da pranzo e tavoli 3 o 4 razze, che offre una varietà di opzioni per diversi tipi di ambienti e utilizzi. I tavoli Mimi hanno un basamento realizzato in alluminio verniciato, disponibile in tre diverse opzioni di colore. Grazie al suo design e alla sua leggerezza la base dei tavoli è impilabile, consentendo così di risparmiare spazio quando quest'ultimi non sono in uso. Questo è particolarmente utile in ambienti dedicati ad ospitare eventi. La collezione Mimi offre la possibilità di scegliere tra due materiali per il piano del tavolo: gres e HPL. Entrambi questi materiali sono noti per la loro robustezza e durata. Nella versione a 3 o a 4 razze, il piano dei tavoli Mimi è disponibile in entrambe le forme, tonda e quadrata, come optional con aggancio rapido, offrendo flessibilità nella scelta del design in base alle esigenze specifiche del progetto o dell'ambiente. Nella versione tavolo da pranzo, sono disponibili i piani rotondi, ideali per incontri conviviali.

Mimi collection consists of dining tables and tables with 3 or 4 spokes, offering a variety of options for different types of environments and uses. Mimi tables have a base made of painted aluminum, available in three different color options. Thanks to its design and lightweight construction, the table bases are stackable, allowing you to save space when they are not in use, which is particularly useful in environments dedicated to hosting events. The Mimi collection offers the choice of two materials for the table top: stoneware and HPL. Both of these materials are known for their robustness and durability. In the 3 or 4 spokes version, the tabletop of Mimi tables is available in both round and square shapes, featuring as optional quick attachment, providing flexibility in choosing the design based on specific project or environment needs. In the dining table version, round tabletops are available, ideal for convivial gatherings.

**Tavolo contract 3 razze 69x69 -  $\varnothing$  69**  
3 spokes contract table 69x69 -  $\varnothing$  69

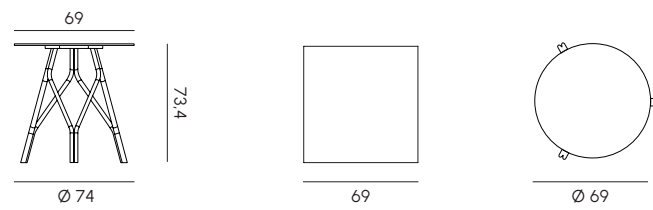

**Tavolo contract 4 razze  $\varnothing$  120**  
4 spokes contract table  $\varnothing$  120

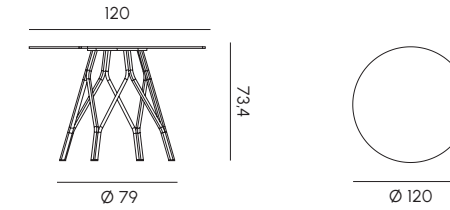

**Tavolo contract 3 razze 79x79 -  $\varnothing$  79**  
3 spokes contract table 79x79 -  $\varnothing$  79

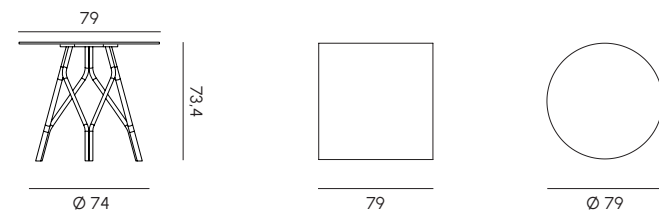

**Tavolo da pranzo  $\varnothing$  160**  
Dining table  $\varnothing$  160

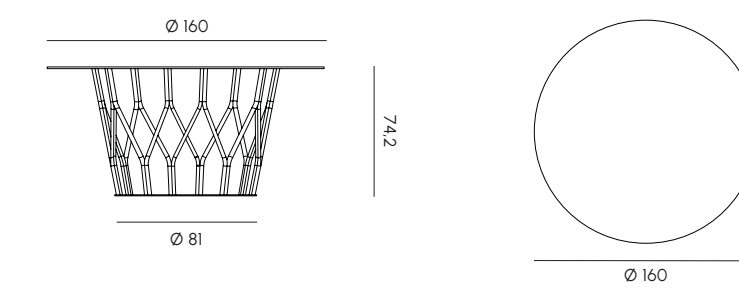

**Tavolo contract 4 razze 89x89 -  $\varnothing$  89**  
4 spokes contract table 89x89 -  $\varnothing$  89

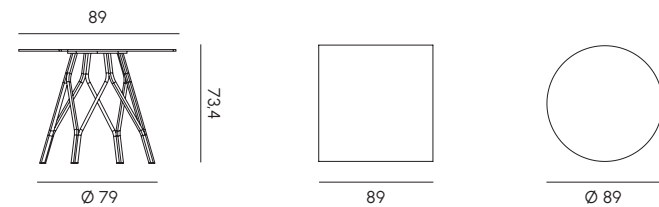

**Tavolo da pranzo  $\varnothing$  180 \***  
Dining table  $\varnothing$  180

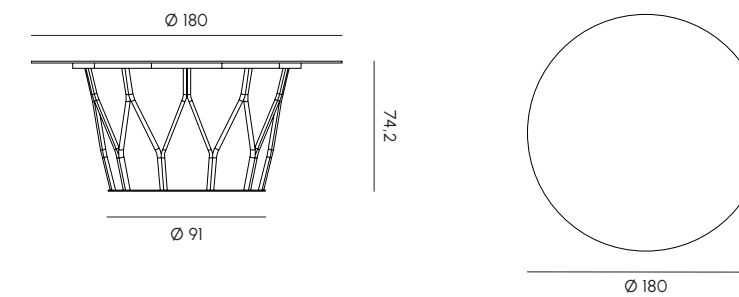

**Tavolo contract 4 razze 99x99 -  $\varnothing$  99**  
4 spokes contract table 99x99 -  $\varnothing$  99

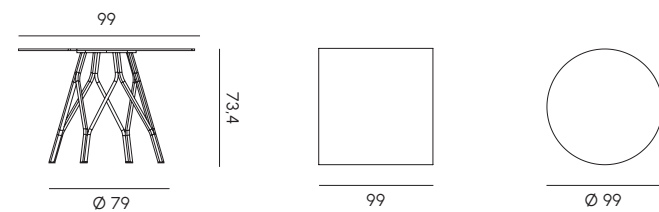

\* Disponibili solo con piano in HPL e per ordini superiori a 10 tavoli  
Available only with HPL top and or orders more than 10 tables

|                                |   |                       |  |
|--------------------------------|---|-----------------------|--|
| Struttura                      | Estruso di alluminio verniciato a polvere epossidiche.  | Frame                 | Epoxy powder-coated extruded aluminium |
| Piano                          | HPL. Gres porcellanato                                  | Top                   | HPL. Porcelain stoneware               |
| Piedini                        | Materiale termoplastico                                 | Feets                 | Thermo-plastic material                |
| Telo di copertura impermeabile | Poliestere con superficie esterna resinata impermeabile | Waterproof cove cloth | Polyester with external resin surface  |

### Abbinamenti tavoli da pranzo e tavoli contract

Combinations for dining tables and contract tables

#### Structure

Aluminium



gunmetal  
223



metallic sand gray  
358



matt white  
222

#### Top

HPL/ Stoneware



HPL  
white black core  
054



HPL  
gray black core  
097



marble white  
03GL



marble black  
01GL



gray  
05



HPL  
white black core  
054



HPL  
gray black core  
097



marble white  
03GL



marble black  
01GL



gray  
05



HPL  
white black core  
054



HPL  
gray black core  
097



marble white  
03GL



marble black  
01GL



gray  
05

Le immagini dei materiali e dei colori sono indicative, in quanto possono subire lievi variazioni in stampa.  
The materials and colors images serve as a mere indication, as they can vary slightly when printed.

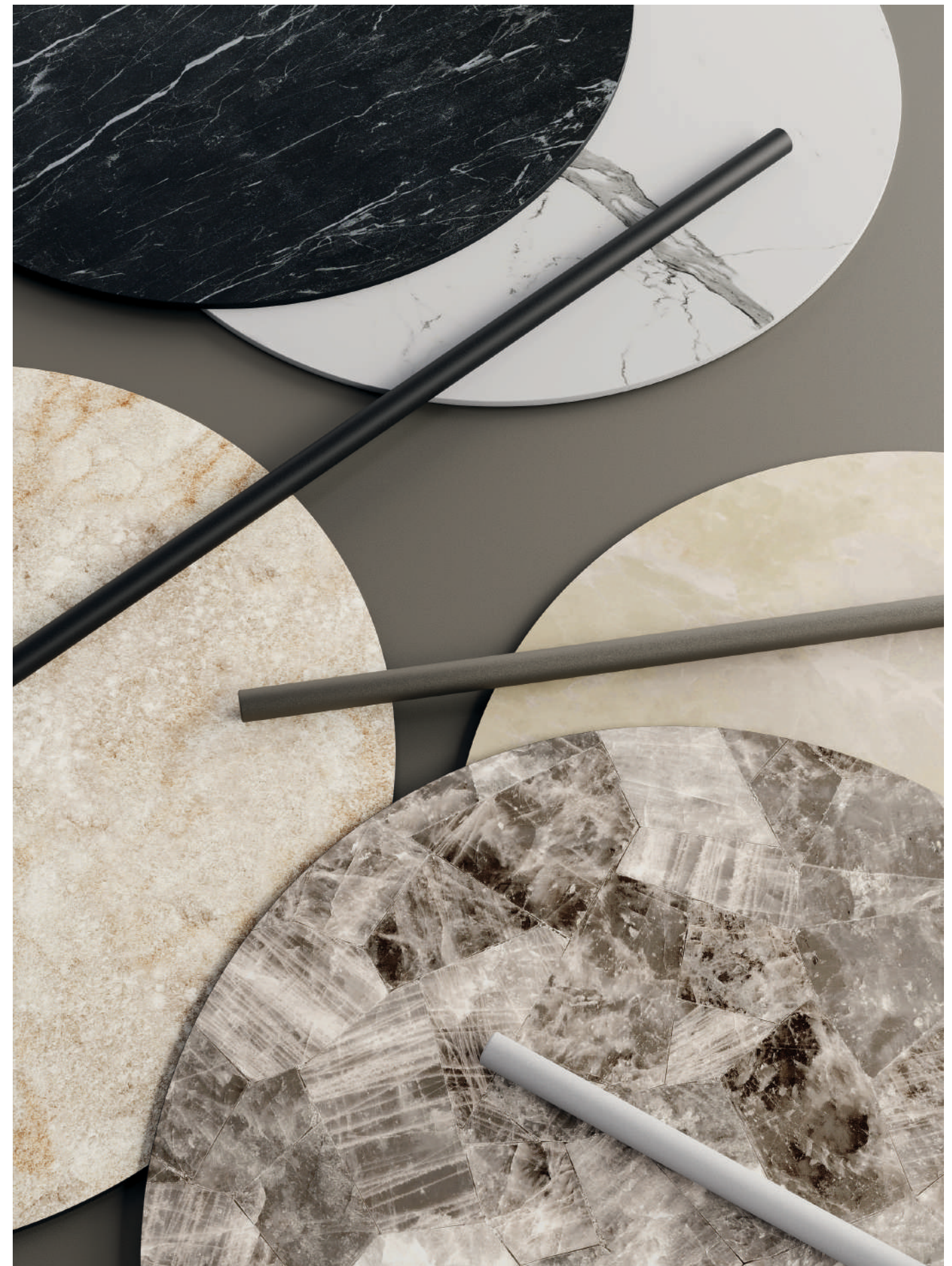



### Maja

Maja è un elegante tavolo da pranzo con un design minimalista e leggero. È realizzato in alluminio estruso verniciato con polveri epossidiche e offre una scelta di due colori. Maja è disponibile allungabile, per la versione da pranzo, con una prolunga che può essere riposta al suo interno nell'apposito vano, sia fissa per la versione contract per soddisfare diverse esigenze. I piani del tavolo da pranzo Maja sono realizzati in alluminio con doghe ad incastro fra loro nella stessa tonalità della struttura, in gres in numerosi colori o in HPL in due colori a seconda del modello scelto. Questa varietà di materiali offre opzioni di design e resistenza diverse. Per la versione contract i piani possono essere in gres o in hpl in base alla misura scelta. Le misure disponibili per il tavolo Maja sono tre per il tavolo da pranzo e quattro per la versione contract. Per questo settore è disponibile inoltre un tavolo alto in una unica misura. Nel complesso, il tavolo Maja è una scelta versatile e elegante per l'arredamento di esterni e non solo.

Maja is an elegant dining table with a minimalist and lightweight design. It's crafted from powder-coated extruded aluminum and is available in a choice of two colors. Maja comes in an extendable version for the dining variant, featuring an extension that can be stored within a dedicated compartment, and a fixed version for the contract variant to accommodate different needs. The tops for Maja dining table are made of interlocking aluminum slats in the same color as the frame, available in numerous colors of grès or in HPL in two colors depending on the chosen model. This variety of materials offers different design options and durability. For the contract version, the tabletops can be in grès or HPL, depending on the selected size. There are three available sizes for the dining table and four for the contract version. Additionally, for this sector, there's a high table available in a single size. Overall, the Maja table is a versatile and stylish choice for outdoor and indoor furniture.

### Tavolo da pranzo Dining table

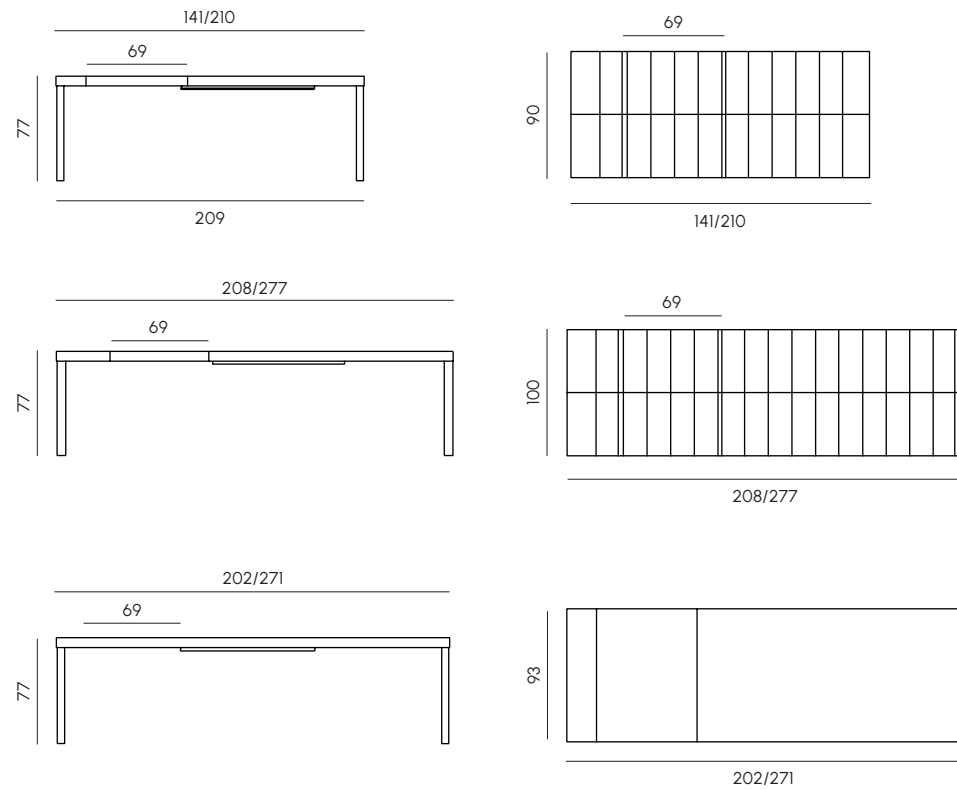

### Tavoli contract HPL Contract tables HPL

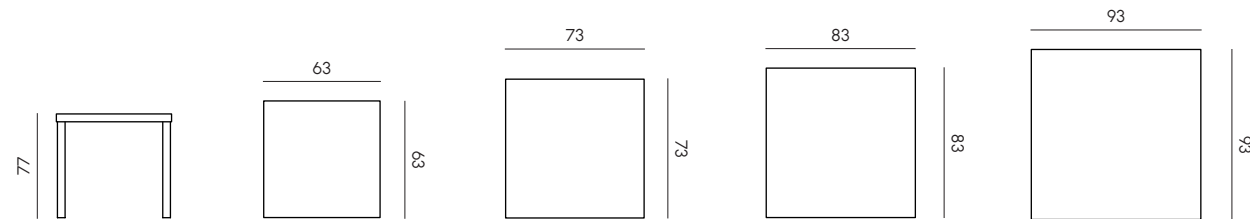

### Tavolo contract alto HPL 63x63 Contract high table HPL 63x63

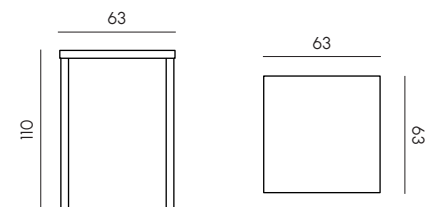

Le immagini dei materiali e dei colori sono indicative, in quanto possono subire lievi variazioni in stampa.  
The materials and colors images serve as a mere indication, as they can vary slightly when printed.

|                                |  |                       |  |
|--------------------------------|--|-----------------------|--|
| Struttura                      | Estruso di alluminio verniciati a polvere ipossidiche. | Frame                 | Epoxy powder-coated extruded aluminium |
| Piano                          | Alluminio, Gres porcellanato e HPL                     | Top                   | Aluminium, Porcelain stoneware and     |
| Piedini                        | Materiale termoplastico                                | Feets                 | Thermo-plastic material                |
| Telo di copertura impermeabile | Poliestere con superficie esterna resinata             | Waterproof cove cloth | Polyester with external resin surface  |

### Abbinamenti per tavoli Combinations for tables

Tavolo da pranzo 210 (141+69)x90 e 277 (208+69)x100  
Dining table 210 (141+69)x90 and 277 (208+69)x100

### Structure and slats top Aluminium

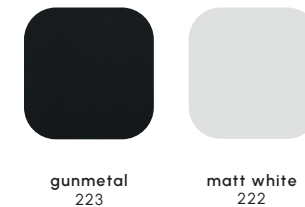

Tavoli contract e tavolo da pranzo 271 (202+69)x93  
Contract tables and dining table 271 (202+69)x93

### Structure Aluminium

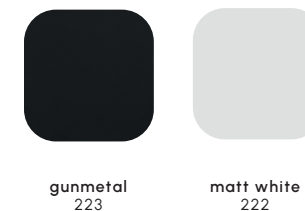

### Top HPL/ Stoneware

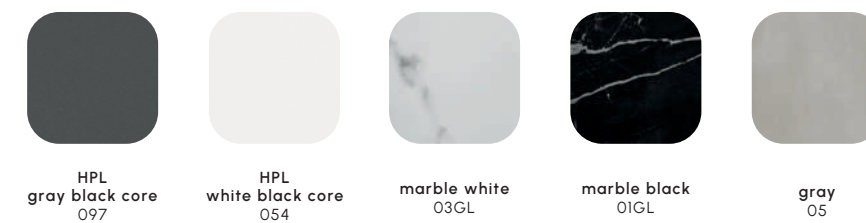



## Sofia

Sofia è una poltroncina da pranzo realizzata in polipropilene riciclabile. È disponibile in sei diversi colori, offrendo una varietà di opzioni per adattarsi ai gusti personali o all'arredamento dell'ambiente in cui verrà posizionata. La poltroncina è composta da una struttura per le gambe a supporto della seduta che viene facilmente fissata mediante delle viti, questo facilita l'assemblaggio e permette una facile sostituzione o manutenzione della seduta. Sofia può essere personalizzata ulteriormente scegliendo di avere le gambe in bianco, in nero o in fibra di legno in combinazione con la scocca della seduta, permettendo così di creare una poltroncina bicolore che si adatti ai diversi ambienti. Come optional, è possibile aggiungere un cuscino sfoderabile fissato alla seduta, disponibile in cinque diverse nuance di tessuto, offrendo ulteriori opzioni di personalizzazione e comfort.

Sofia is a dining armchair made of recyclable polypropylene. It is available in six different colors, offering a variety of options to suit personal preferences or the decor of the environment where it will be placed. The armchair consists of a leg frame to support the seat, which is easily attached with screws. This makes assembly straightforward and allows for easy replacement or maintenance of the seat. Sofia can be further customized by choosing to have the legs in white, black, or wood fiber in combination with the seat shell, allowing you to create a two-tone armchair that fits To different environments. As an option, it's possible to add a removable cushion attached to the seat, available in five different fabric shades, providing additional customization and comfort options.

### Poltrona da pranzo Dining armchair

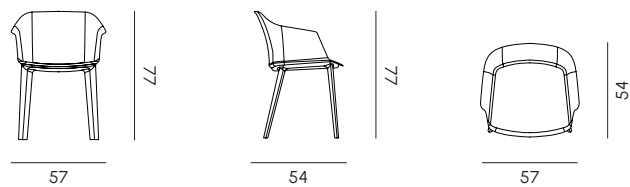

|                      |   |
|----------------------|---|
| Seduta               | Polipropilene                                 |
| Gambe                | Polipropilene + fibre di vetro o plastic-wood |
| Imbottitura cuscini  | Poliuretano sagomato                          |
| Rivestimento cuscini | Tessuto idrorepellente per esterni            |

|                     |   |
|---------------------|---|
| Seat                | Polypropylene                               |
| Legs                | Polypropylene + glass fiber or plastic-wood |
| Cushions upholstery | Shaped polyurethane                         |
| Cushions cover      | Outdoor water-repellent fabric              |

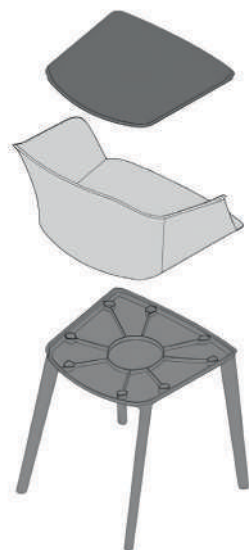

Il cuscino sfoderabile viene fornito già fissato sulla seduta mediante un supporto.

The removable cushion is supplied already fixed to the seat by means of a support

Lotti di vendita 4 pezzi  
Lots for sale 4 pieces

Le immagini dei materiali e dei colori sono indicative, in quanto possono subire lievi variazioni in stampa.  
The materials and colors images serve as a mere indication, as they can vary slightly when printed.

### Abbinamenti per poltroncina da pranzo Combinations for dining armchair

#### Monocolor Seat & legs Polypropylene / Polypropylene + glass fiber



#### Structure Legs Polypropylene + glass fiber or wood fiber

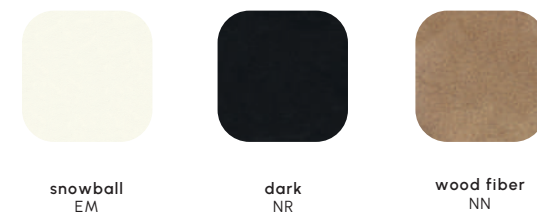

#### Structure Seat Polypropylene



#### Optional Fabric cushion

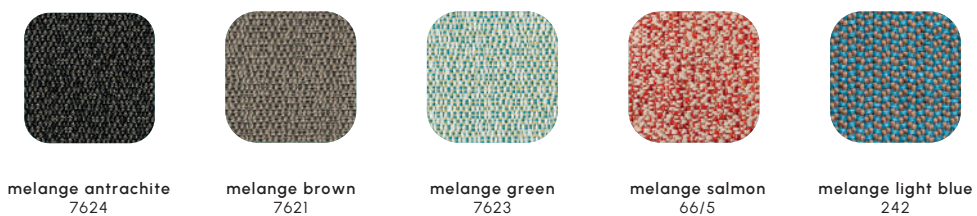

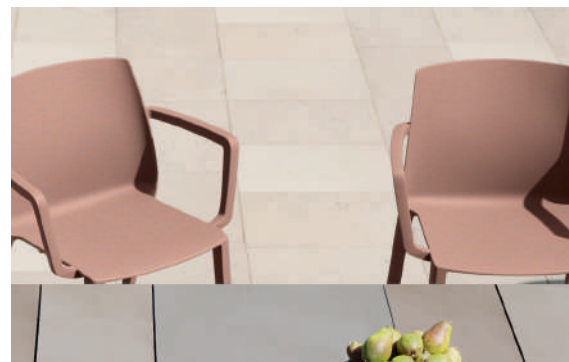

### Sedia Chair

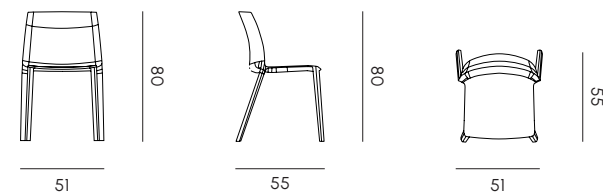

### Sedia con braccioli Chair with armrests

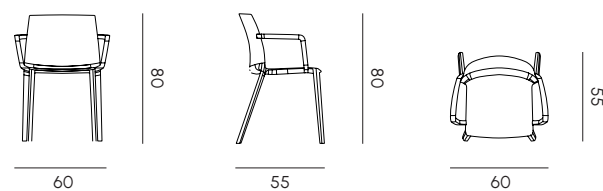

## Ada

La sedia Ada è disponibile sia con che senza braccioli, realizzata in polipropilene con tecnologia stampaggio ad iniezione, tecnica di produzione che consente di ottenere arredi resistenti. Ada è progettata per essere impilabile a lotti di 7 pezzi. I quattro tappi posti sotto la seduta della sedia sono studiati per consentire un impilamento senza danneggiare o graffiare le sedie sottostanti. Le estremità delle gambe sono dotate di piedini antiscivolo intercambiabili. Sono disponibile cinque diverse opzioni di colore.

Ada chair is available both with and without armrests, made of polypropylene using injection molding technology, a production technique that ensures durable furniture. Ada is designed to be stackable in batches of 7 pieces. The four caps placed under the chair seat are designed to allow stacking without damaging or scratching the chairs underneath. The leg ends come with interchangeable non-slip feet. Five different color options are available.



|           |                                |       |                             |
|-----------|--------------------------------|-------|-----------------------------|
| Struttura | Polipropilene + fibre di vetro | Frame | Polypropylene + glass fiber |
| Piedini   | Polipropilene                  | Feets | Polypropylene               |

**Abbinamenti per sedia e sedia con braccioli**  
 Combinations for chair e chair with armrests

**Structure**  
 Polypropylene + glass fiber



Lotti di vendita 4 pezzi  
 Lots for sale 4 pieces

**Le immagini dei materiali e dei colori sono indicative, in quanto possono subire lievi variazioni in stampa.**  
 The materials and colors images serve as a mere indication, as they can vary slightly when printed.

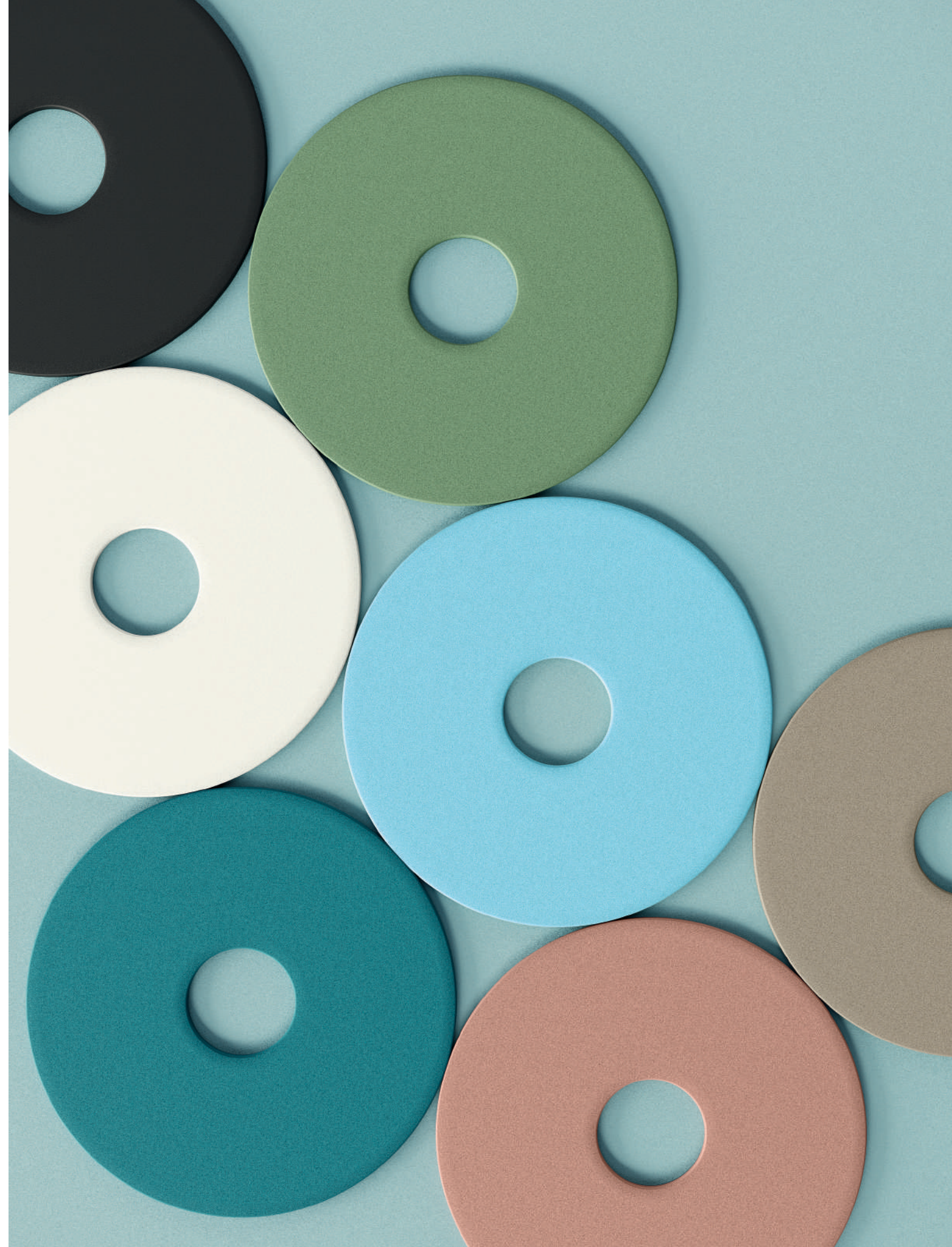

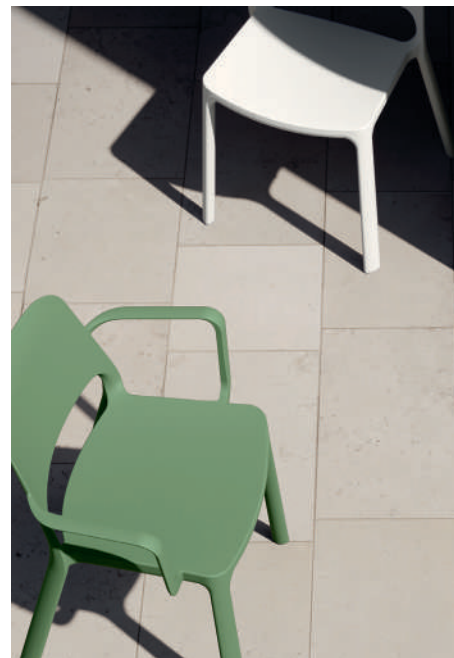

### Sedia Chair

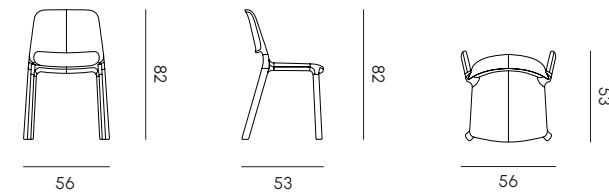

### Sedia con braccioli Chair with armrests

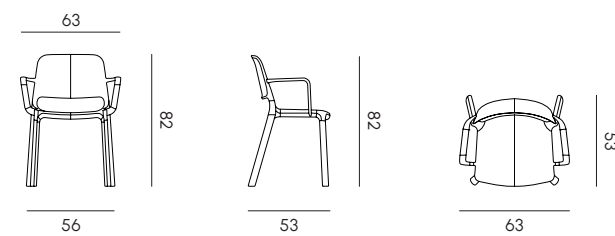

### Sgabello basso Low stool

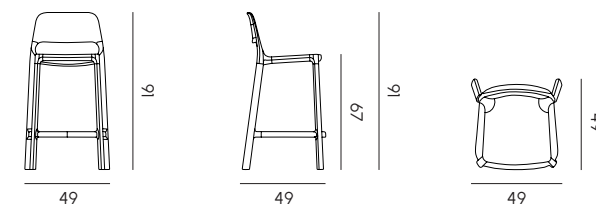

### Sgabello alto High stool

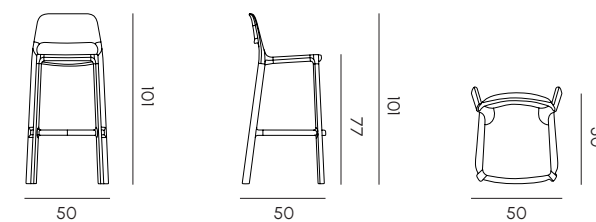

## Tina Collection

La collezione Tina è composta da sedie con e senza braccioli e da due sgabelli.

La collezione è realizzata in polipropilene con tecnologia stampaggio ad iniezione, tecnica di produzione che consente di ottenere arredi resistenti. I quattro tappi posti sotto la seduta sono studiati per consentire un impilamento senza danneggiare o graffiare le sedute sottostanti. Le estremità delle gambe sono dotate di piedini antiscivolo intercambiabili. Le sedie in entrambe le versioni sono impilabili a 5 e sono realizzate in polipropilene. Anche gli sgabelli sono impilabili. Sono disponibili in una varietà di cinque colori diversi, offrendo diverse opzioni estetiche per l'arredamento.

Tina Collection comprises chairs with and without armrests and two stools. The collection is made of polypropylene using injection molding technology, a production technique that ensures durable furniture. The four caps placed under the seat are designed to allow stacking without damaging or scratching the seats below. The leg ends feature interchangeable non-slip feet. Both versions of the chairs can be stacked up to 5 and are made of polypropylene. The stools are stackable as well. They are available in a variety of five different colors, offering various aesthetic options for furnishing.

|           |                                |       |                             |
|-----------|--------------------------------|-------|-----------------------------|
| Struttura | Polipropilene + fibre di vetro | Frame | Polypropylene + glass fiber |
| Piedini   | Polipropilene                  | Feets | Polypropylene               |

**Abbinamenti per sedia, sedia con braccioli e sgabelli**  
 Combinations for chair, chair with armrests and stools

**Structure**  
 Polypropylene



Lotti di vendita 4 pezzi  
 Lots for sale 4 pieces

**Le immagini dei materiali e dei colori sono indicative, in quanto possono subire lievi variazioni in stampa.**  
 The materials and colors images serve as a mere indication, as they can vary slightly when printed.





Lettino  
Sunbed

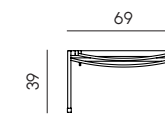
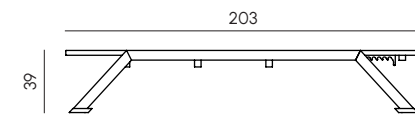

## Betty

Il lettino Betty è caratterizzato da una struttura in alluminio estruso e una seduta in textilene. Questo design lo rende leggero, resistente e adatto all'uso all'aperto. È disponibile in due colori differenti per adattarsi a diverse preferenze estetiche. Inoltre, è progettato per essere impilabile fino a 10 lettini, rendendo lo stoccaggio più facile ed efficiente. Per migliorare la mobilità, è possibile optare per l'aggiunta di ruote come optional, rendendo più semplice lo spostamento dei lettini. Il design semplice e funzionale lo rende una scelta pratica per aree esterne come piscine, terrazze o giardini.

Betty sun lounger features an extruded aluminum frame and a textilene seat. This design makes it lightweight, durable, and suitable for outdoor use. It's available in two different colors to suit various aesthetic preferences. Additionally, it's designed to be stackable up to 10 loungers, making storage easier and more efficient. For enhanced mobility, optional wheels can be added, making it easier to move the loungers. Its simple and functional design makes it a practical choice for outdoor areas such as pools, terraces, or gardens.

**Abbinamenti lettino**  
Combinations for sunbed

**Structure**  
Aluminium

**Seat covering**  
Textilene®

**Optional**  
Fabric mattress



gunmetal  
223



black  
0400

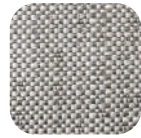

savane zinc  
2361

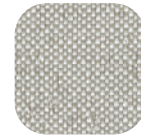

melange silver  
39/3



matt white  
222

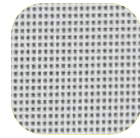

white  
0108

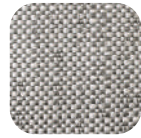

savane zinc  
2361

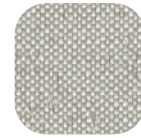

melange silver  
39/3

|                               |   |                          |   |
|-------------------------------|---|--------------------------|---|
| Struttura                     | Estruso di alluminio verniciato a polveri epossidiche | Frame                    | Epoxy powder-coated extruded aluminium                    |
| Seduta                        | Textilene®  | Seat                     | Textilene®  |
| Piedini                       | Materiale termoplastico                               | Feets                    | Thermo-plastic material                                   |
| Ruote/<br>dove previsto       | Materiale termoplastico                               | Wheels/<br>dove previsto | Thermo-plastic material                                   |
| Materassino                   | Poliuretano sagomato, fodera in tessuto per esterni   | Mattress                 | Shaped polyurethane, Outdoor water-repellent fabric cover |
| Telo a copertura impermeabile | Poliestere con superficie resinata                    | Waterproof cove cloth    | Polyester with external resin surface                     |

Le immagini dei materiali e dei colori sono indicative, in quanto possono subire lievi variazioni in stampa.  
The materials and colors images serve as a mere indication, as they can vary slightly when printed.



### Materassone galleggiante Floating lounge mattress

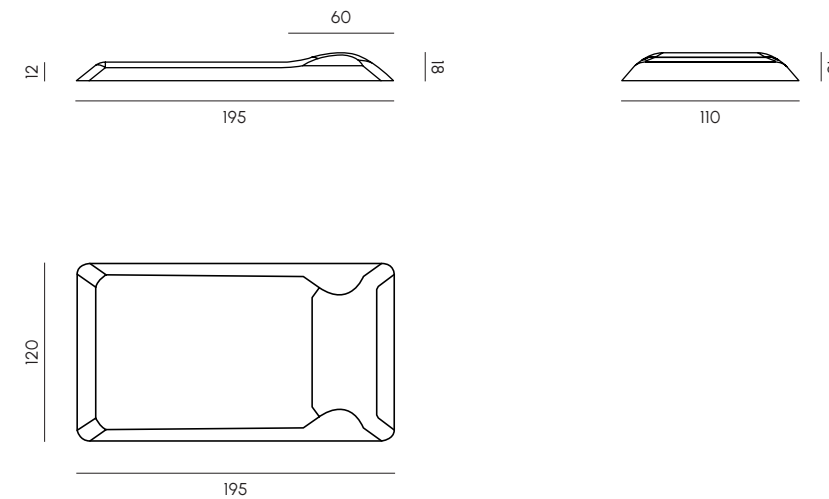

#### Louis

Il cuscino sagomato galleggiante Louis è l'emblema del comfort e della praticità. La sua imbottitura in poliuretano ad alta densità offre un ottimo sostegno ed il rivestimento in ecopelle ricorda il tessuto, le cui caratteristiche intrinseche lo rendono adatto a resistere alle intemperie e ai raggi UV. L'ecopelle è estremamente facile da pulire. Grazie all'alta densità della schiuma interna e al suo design è molto facile la risalita quando posizionato in piscina. Louis è disponibile in 4 colori e grazie alla struttura galleggiante, è perfetto per rilassarsi in acqua o a bordo piscina, creando un'atmosfera di comfort e piacere.

The shaped floating cushion, Louis,, embodies comfort and practicality. Its high-density polyurethane padding provides excellent support, while its eco-leather covering, resembling fabric, is inherently suitable for withstanding weather conditions and UV rays. Eco-leather is extremely easy to clean. Thanks to the high density of the inner foam and its design, getting back up when positioned in the pool is effortless. Louis is available in 4 colors and, with its floating structure, is perfect for relaxing in the water or by the pool, creating an atmosphere of comfort and pleasure.

|              |                             |            |                           |
|--------------|-----------------------------|------------|---------------------------|
| Imbottitura  | Poliuretano ad alta densità | Upholstery | High density polyurethane |
| Rivestimento | Ecopelle effetto tessuto    | Cover      | Eco-leather fabric aspect |

**Colori disponibili**  
Available colors



juta  
603



white/light blue  
818



white/orange  
814



white/yellow  
815

Le immagini dei materiali e dei colori sono indicative, in quanto possono subire lievi variazioni in stampa.  
The materials and colors images serve as a mere indication, as they can vary slightly when printed.





### Poltrona Armchair

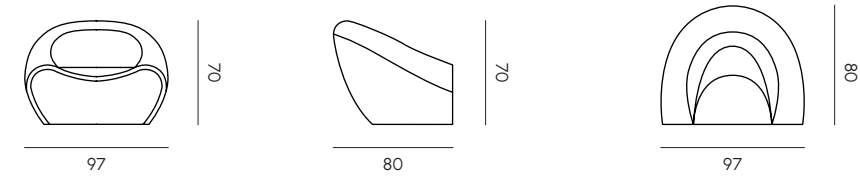

### Tavolino Coffee table

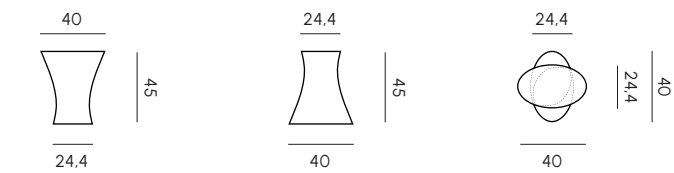

### Sgabello Stool

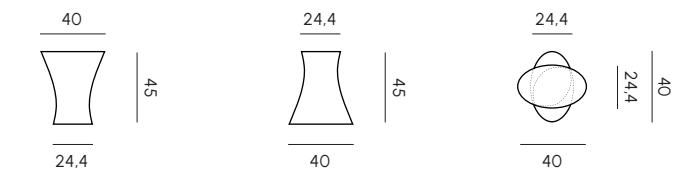

### Tavolo Table

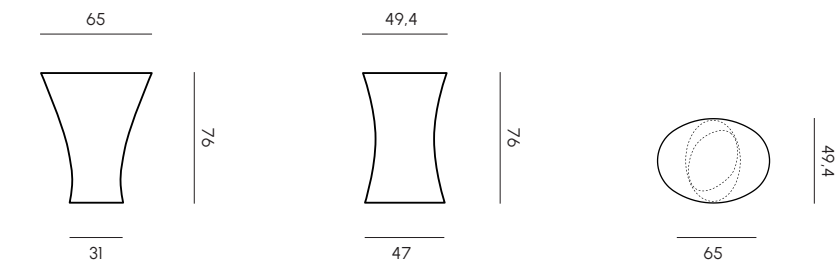

## Iris collection

La collezione Iris offre una gamma di arredi in poleasy riciclabile, progettati per creare zone lounge e chill out. La poltrona e il tavolino sono la combinazione perfetta per creare un ambiente accogliente, mentre lo sgabello con il tavolo sono ideali per le zone bar e conviviali. Per la poltrona sono disponibili due diverse finiture: Goffrato stampato in cinque colori e in effetto velluto in tre. Per il resto della collezione sono disponibili i 5 colore in gofrato stampato. Inoltre, la caratteristica unica del Poleasy, l'innovativo polietilene con cui è prodotta l'intera collezione, è che garantisce resistenza alle intemperie e offre una facile pulizia e manutenzione.

The Iris Collection offers a range of furniture made from recyclable Poleasy, designed to create lounge and chill-out areas. The armchair and coffee table are the perfect combination to create a cozy environment, while the stool with the table is ideal for bar and social areas. For the armchair, two different finishes are available: embossed moulded in five colors and a velvet effect in three. For the rest of the collection, the embossed moulded is available in five colors. Additionally, the table and stools are also available in a rechargeable battery-powered illuminated version in a translucent color. Furthermore, the unique feature of Poleasy, the innovative polyethylene used to produce the entire collection, is that it ensures weather resistance and offers easy cleaning and maintenance.



|           |          |       |          |
|-----------|----------|-------|----------|
| Struttura | Poleasy® | Frame | Poleasy® |
|-----------|----------|-------|----------|

**Abbinamenti per poltrona, sgabello, tavolino e tavolo**  
Combinations for armchair, stool, coffee table and table

**Finishing**  
Basic - GS

**Finishing**  
Velvet - VL\*



white  
117



turquoise  
410



beige  
804



aqua green  
P120



coral  
400



aqua green  
P120



brown  
92



green  
P845

\* Per le finiture Velvet aqua green la quantità minima ordinabile è di 6 pezzi  
For aqua green Velvet finishes the minimum order quantity is 6 pieces

Le immagini dei materiali e dei colori sono indicative, in quanto possono subire lievi variazioni in stampa.  
The materials and colors images serve as a mere indication, as they can vary slightly when printed.





Creatore di esperienze outdoor, MY YOUR offre materiali di qualità eccellente per ogni spazio all'aperto. Dalla natura selvaggia alle terrazze coperte, MY YOUR unisce tecnologie avanzate a tessuti eleganti in diversi stili. Tutti i materiali MY YOUR sono Made in Italy, resistenti ai raggi UV, a rapida asciugatura e di facile manutenzione. Oltre alle combinazioni disponibili e selezionate da MY YOUR, è fondamentale la panoramica dei materiali per cogliere tutte le possibilità di personalizzazione e per soddisfare tutte le Vostre esigenze outdoor.

Creator of outdoor experiences, MY YOUR offers the best quality materials for every open-air space. From wild nature to covered terraces, MY YOUR combines advanced technologies to elegant fabric in different styles. All MY YOUR materials are Made in Italy, UV-resistant, quick-drying, and easy to maintain. In addition to MY YOUR available and selected combinations, you can gain of the materials overview for all the customization possibilities to suit all your outdoor needs.

**Materiali strutturali**  
Structural materials

**Aluminium**  
Aluminium

Mimi - Maja - Betty



**matt white**  
222



**gunmetal**  
223



**metallic sand gray \***  
358

**Polipropilene**  
Polypropylene

Sofia



**snowball**  
EM



**dark**  
NR



**cream**  
E7



**swamp**  
SC



**powder**  
ST



**moss**  
SD



**wood fiber \*\***  
NN

Ada



**snowball**  
EM



**road**  
E4



**swamp**  
SC



**powder**  
ST



**moss**  
SD

Tina collection



**snowball**  
EM



**road**  
E4



**beige**  
EV



**swamp**  
SC



**powder**  
ST



**icesurf**  
EJ

**Piani (i materiali sono disponibili in base alle misure)**  
Tops (materials are available by size)

**Gres**  
Stoneware

Mimi -Maja



**marble white**  
03GL

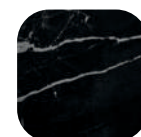

**marble black**  
01GL

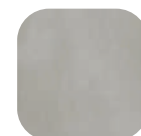

**gray**  
05

**HPL**  
HPL

Mimi - Maja

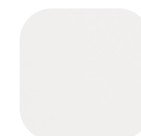

**HPL white black core**  
054



**HPL gray black core**  
097

\* Non disponibile per Maja.  
Not available for Maja.

\*\* Disponibile solo per le gambe.  
Available only for legs.

\* Non disponibile per Mimi.  
Not available for Mimi.

Le immagini dei materiali e dei colori sono indicative, i tessuti non sono in scala.  
The materials and colors images serve as a mere indication, fabrics are not in scale.

**Tessuti**  
Fabrics

Cushion  
Sofia

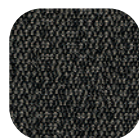

melange antrachite  
7624

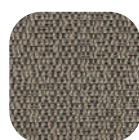

melange brown  
7621

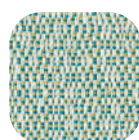

melange green  
7623

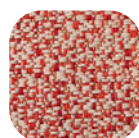

melange salmon  
66/5

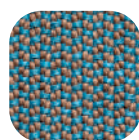

melange light blue  
242

Mattress  
Betty

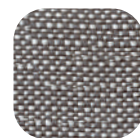

savane zinc  
2361

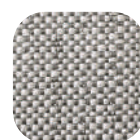

savane silver  
39/3

**Textilene**®

Seat covering  
Betty

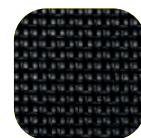

black  
0400

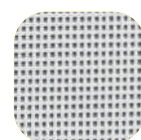

white  
0108

**Ecopelle**  
Eco-leather

Covering  
Louis



juta  
603



white/light blue  
818



white/orange  
814



white/yellow  
815

**Finitura Basic GS**  
Basic Finishing GS

Iris collection

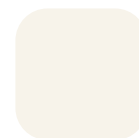

white  
117



turquoise  
410

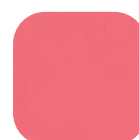

coral  
400



aqua green  
P120



green  
P845

Plastica seconda vita PSV  
Second-life plastic PSV



Nova lounge set  
(Open-air catalogue)



VL Geco anthracite  
50

\* Alcuni colori sono disponibili solo per ordini superiori a 6 pz. Si rimanda, pertanto, al listino.  
Some colors are available only for orders over 6 pcs. We therefore refer to the price list.

**Finitura velluto VL**  
Velvet Finishing VL

Iris collection



beige  
804



aqua green\*  
P210



brown  
92

\* Disponibile solo per ordini superiori a 6 pezzi  
Available only for more than 6 pieces orders

**Le immagini dei materiali e dei colori sono indicative**  
The materials and colors images serve as a mere indication



**MY YOUR**

Rolling Plast srl  
via Nino Bixio 20,  
35010 Gazzo, Padova, Italy  
t +39 049 5963419  
f +39 049 5963335  
info@myyour.eu  
www.myyour.eu

Nella stampa su carta la qualità dei colori non può essere riprodotta fedelmente. MY YOUR si riserva la facoltà di apportare modifiche alle proprie collezioni in qualsiasi momento e senza preavviso.

Color shades can not be reproduced accurately on printed paper. MY YOUR is intitled to make modifications at any time and without notice.

