

# ADD T

Francesco Rota | 2016



# ADD T

Francesco Rota | 2016

Writing, reading, and when the community is enlarged, working and meeting. Minimalist like a verb in its infinitive form, the ADD T table meets the requirements of any environment. With its lightness and great character, the table sparkles with life and its adaptability completes the ADD seating system. Thanks to its die-cast aluminium legs, which create a single corner solution or is extended with the addition of frames, multiple compositions can be created. Cables run, concealed and fixed under the profile. Sockets and power adaptors are inserted in the tabletop. For a calm day, where everything is user-friendly.

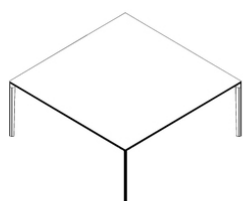

Square

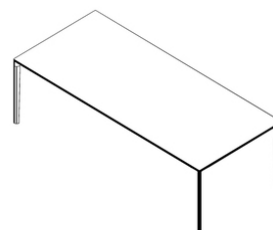

Rectangle

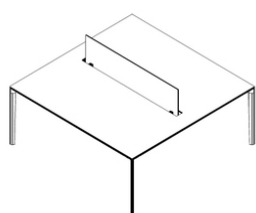

Privacy screen

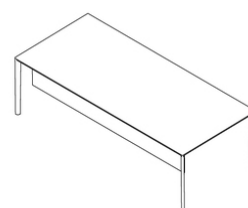

Modesty screen

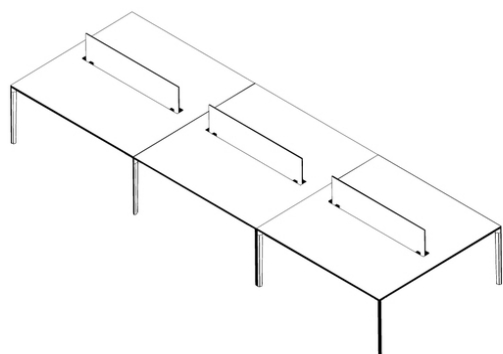

Linked

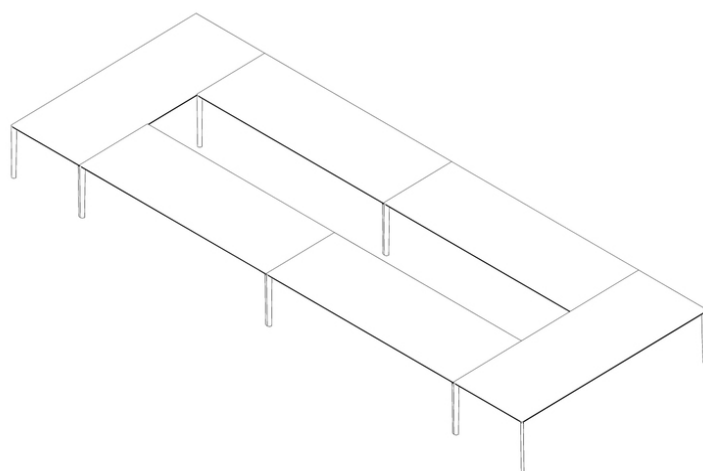

Rectangular conference

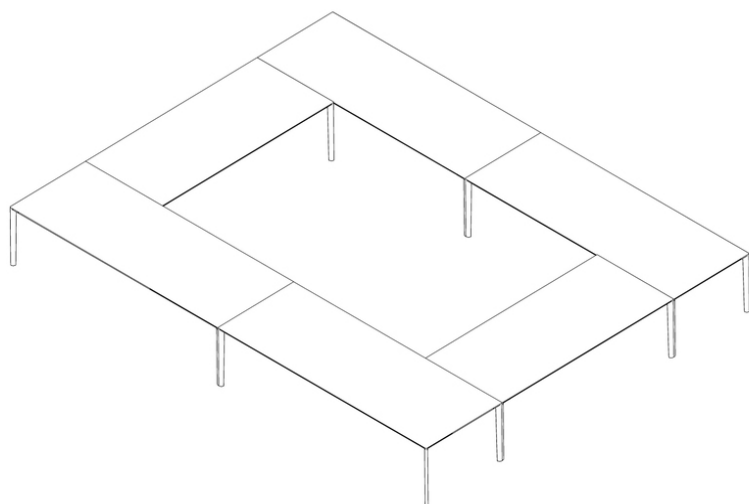

Square conference

# ADD T

Francesco Rota | 2016

Modular system of tables with frame in aluminium extrusion and die-cast aluminium corner and linking legs, all powder coated, which allows several configurations. Tops available in HPL Fenix® 10 mm or veneered in wood in several finishes.

## legs



## tops

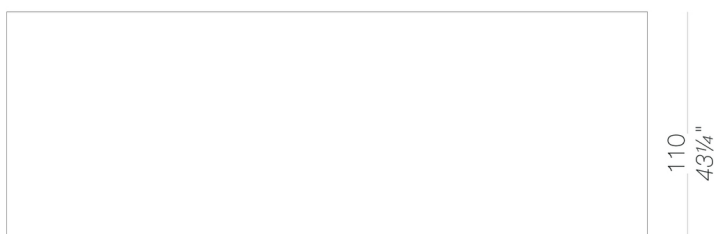
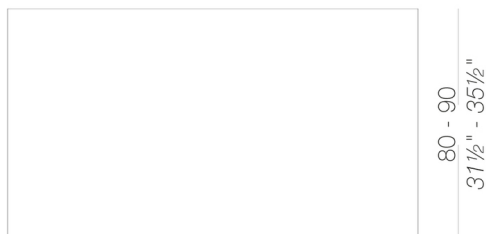

# ADD T

Francesco Rota | 2016

## modesty panel

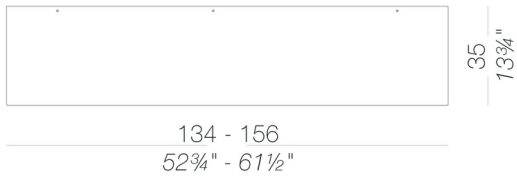

## desk with partition panel and metal tray for cabling

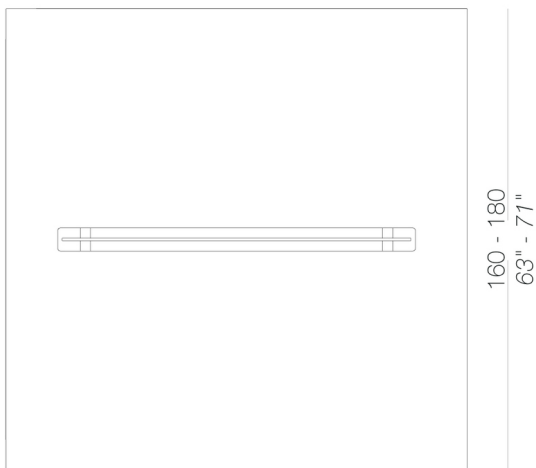
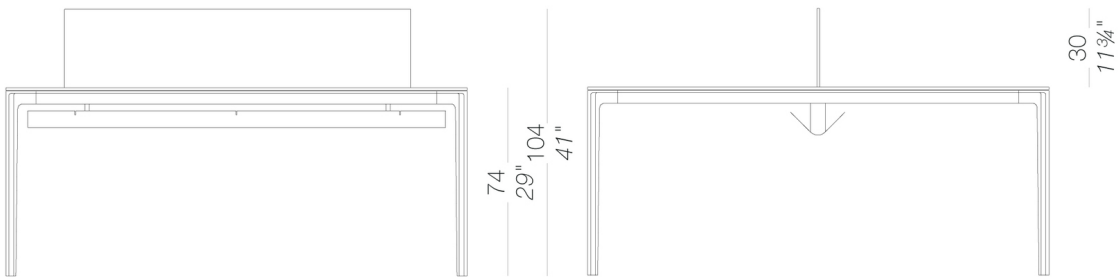

## partition panel

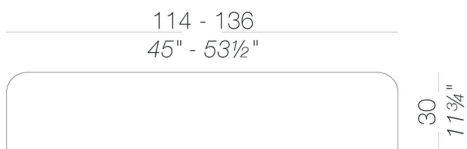

# ADD T

Francesco Rota | 2016

## frame



powder coating  
black  
1 Colors

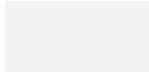

powder coating  
white  
1 Colors

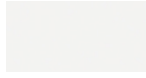

powder coating  
white  
1 Colors

## top



HPL 10 mm  
black HPL fenix  
1 Colors

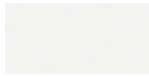

HPL 10 mm  
white HPL fenix  
1 Colors

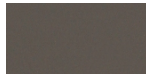

HPL 10 mm  
HPL fenix grigio  
Londra  
1 Colors



HPL 10 mm  
HPL fenix rosso  
Jaipur  
1 Colors



wood  
blanch oak  
1 Colors

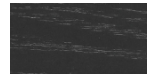

wood  
black open pore  
1 Colors

## partition panel



HPL 10 mm  
black HPL fenix  
1 Colors

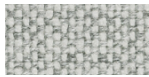

fabric  
Hallingdal 65  
58 Colors



fabric  
Canvas 2  
45 Colors

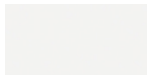

HPL 10 mm  
white HPL fenix  
1 Colors



fabric  
Steelcut Trio 3  
54 Colors

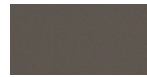

HPL 10 mm  
HPL fenix grigio  
Londra  
1 Colors



fabric  
Remix 3  
72 Colors



HPL 10 mm  
HPL fenix rosso  
Jaipur  
1 Colors



wood  
blanch oak  
1 Colors

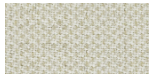

fabric  
Clara 2  
24 Colors

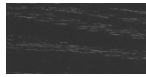

wood  
black open pore  
1 Colors



fabric  
Fiord 2  
39 Colors



fabric  
Divina MD  
27 Colors



fabric  
Divina Melange 3  
38 Colors



fabric  
Tonica 2  
39 Colors

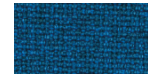

fabric  
Medley  
37 Colors



fabric  
Jet  
66 Colors

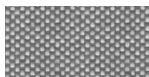

fabric  
Maya  
43 Colors

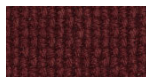

fabric  
Lapalma Smart  
18 Colors

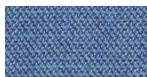

fabric  
Capture  
43 Colors



fabric  
Crisp  
40 Colors

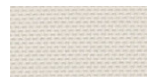

fabric  
Nattè  
23 Colors

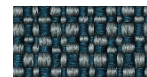

fabric  
Iris  
24 Colors



fabric  
Steelcut 3  
37 Colors

## modesty panel



HPL 10 mm  
black HPL fenix  
1 Colors



HPL 10 mm  
white HPL fenix  
1 Colors

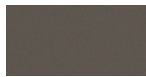

HPL 10 mm  
HPL fenix grigio  
Londra  
1 Colors



HPL 10 mm  
HPL fenix rosso  
Jaipur  
1 Colors

consult the portfolio for the range of colors, fabrics, eco-leather, soft-leather.

## use and maintenance instructions

Clean all parts in wood, leather, fabric and metal with a damp cloth or a diluted neutral cleaner. Do not use cleaners with alcohol, bleach, solvent or abrasive products. Any liquid spilt on the product must be wiped up immediately. When lifting or moving the product, hold it on the structure and not under the seat. The product should not be subjected to unbalanced weights, as it is designed for a proper rest on the foothold (on four legs or on the base). Our company relieves from any responsibility in case of damage caused to fragile floors. Avoid any improper use of the product: do not step on the product, on the footrest or on the armrests. Avoid any movements that could compromise the proper functionality of the product or the safety of the users. Wood and leather, being natural materials, could be easily damaged. Small impurities or imperfections are within quality standard range. Do not expose the product to weather conditions or atmospheric agents, nor to heat sources over 40°C. Also products for outdoor use could be afflicted by atmospheric agents. The product could undergo possible exterior changes due to particular exposure to heat, humidity and saltiness. An appropriate and frequent maintenance and cleaning of the product enhances its durability. The product could change colour and shade, if exposed to direct sunlight. Maintenance has to be carried out by experienced staff. Dispose of the package only after assembling the product, in order to avoid the loss of ironmongery and components. Once the product has been dismantled, the product itself or its components must be given to the public garbage disposal system, according to the legislation in force.