

# ARCO

Francesco Rota | 2016



# ARCO

Francesco Rota | 2016

If objects had their own life, we could say that ARCO is a chair that “embraces”. Thanks to its hidden screw system, the curved wood backrest is smoothly joined to the solid wood seat, with the design creating a continuous line that magically brings together each part. The support is exceptionally comfortable and the opening allows you to sit in a relaxing position in total freedom. Also in the upholstered version, the ARCO chair “embraces” any environment, from the office to the home, an elegant bar or a restaurant with a contemporary atmosphere.



# ARCO

Francesco Rota | 2016

## S210 upholstered seat

### ARCO | S210 S211 S214 S216

Chair with lacquered wooden seat and backrest or upholstered in fabric or eco-leather. Swivel base in varnished wood. Available with swivel aluminium base, also height adjustable on castors. Powder coated or sandblasted.

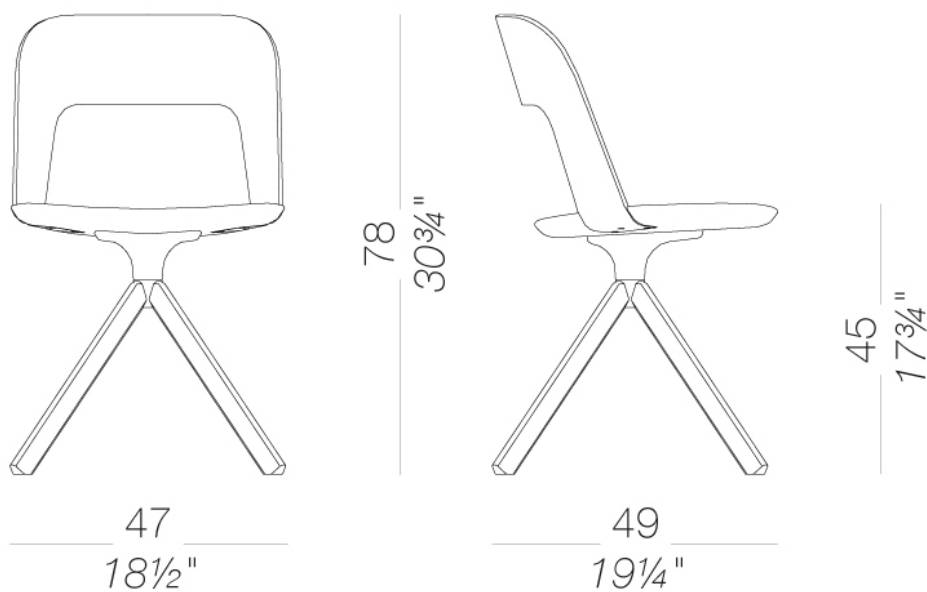

# ARCO

Francesco Rota | 2016

**S211 Entirely in wood or upholstered**

**ARCO | S210 S211 S214 S216**

Chair with lacquered wooden seat and backrest or upholstered in fabric or eco-leather. Swivel base in varnished wood. Available with swivel aluminium base, also height adjustable on castors. Powder coated or sandblasted.

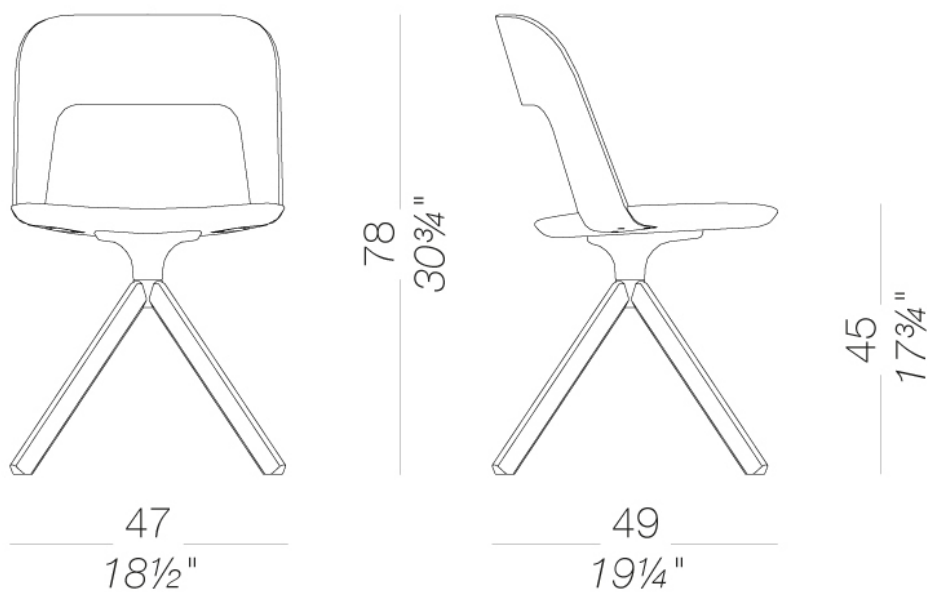

# ARCO

Francesco Rota | 2016

**S214 Upholstered or in wood, on castors**

**ARCO | S210 S211 S214 S216**

Chair with lacquered wooden seat and backrest or upholstered in fabric or eco-leather. Swivel base in varnished wood. Available with swivel aluminium base, also height adjustable on castors. Powder coated or sandblasted.

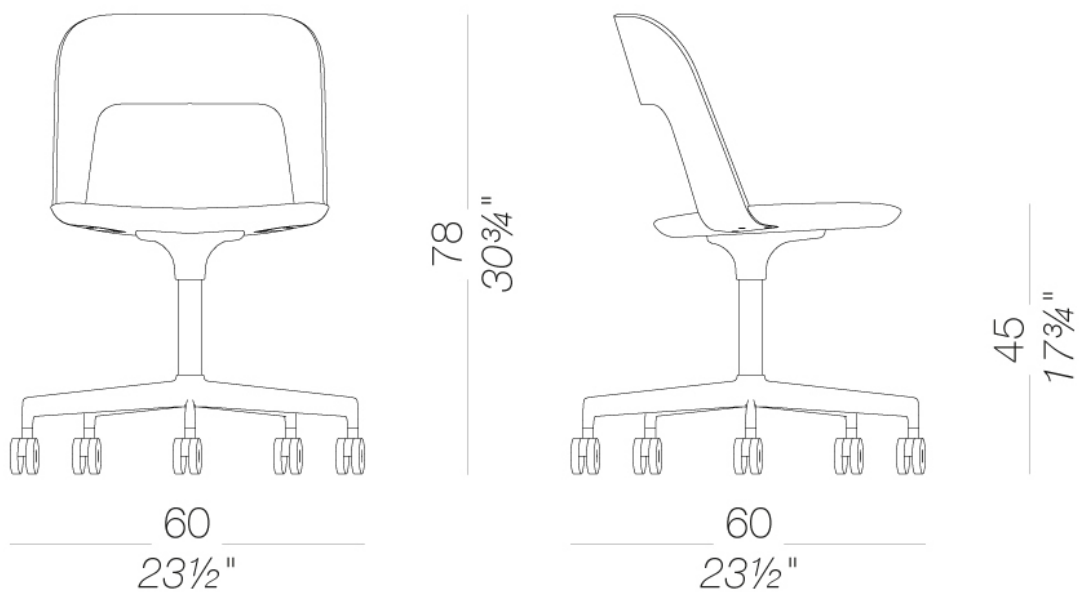

# ARCO

Francesco Rota | 2016

## S216 Swivel and height-adjustable

### ARCO | S210 S211 S214 S216

Chair with lacquered wooden seat and backrest or upholstered in fabric or eco-leather. Swivel base in varnished wood. Available with swivel aluminium base, also height adjustable on castors. Powder coated or sandblasted.

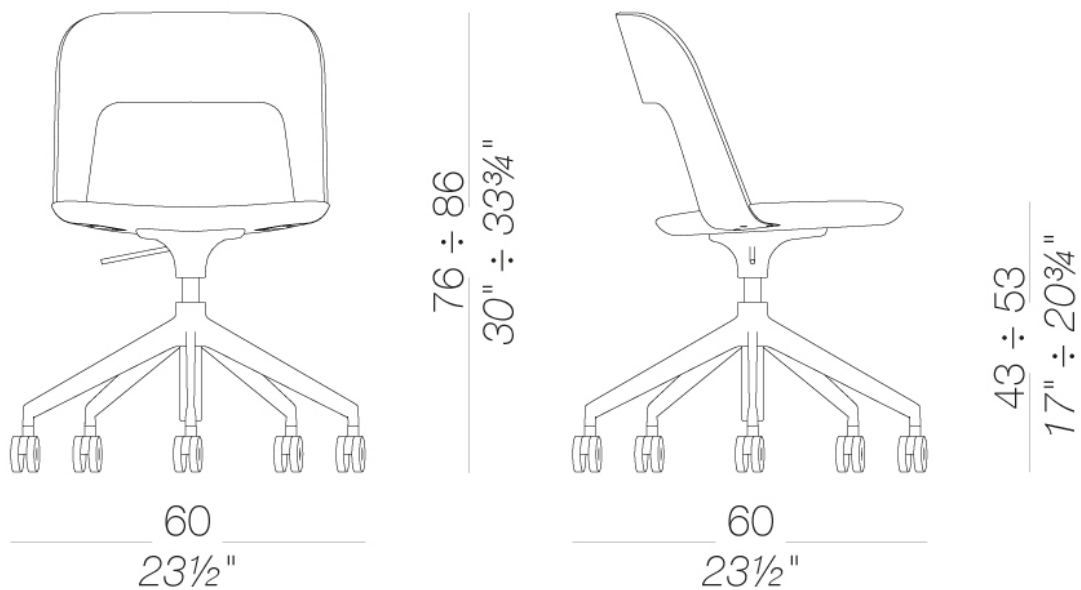

# ARCO

Francesco Rota | 2016

## frame

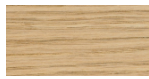

wood  
blanch oak  
1 Colors



powder coating  
black  
1 Colors

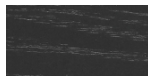

wood  
black open pore  
1 Colors

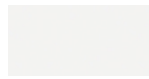

powder coating  
white  
1 Colors



metal  
aluminium  
1 Colors

## seat

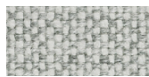

fabric  
Hallingdal 65  
47 Colors



fabric  
Canvas 2  
40 Colors



fabric  
Steelcut Trio 3  
48 Colors



fabric  
Remix 2  
24 Colors



fabric  
Clara 2  
24 Colors

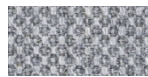

fabric  
Fiord  
24 Colors



fabric  
Divina MD  
24 Colors



fabric  
Divina Melange 2  
24 Colors



fabric  
Tonica 2  
39 Colors



fabric  
Medley  
37 Colors



fabric  
Swing  
24 Colors

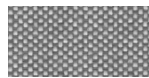

fabric  
Maya  
43 Colors



fabric  
Jet  
44 Colors



fabric  
Laser J Flash  
24 Colors



ecoleather  
GRIMM FR  
24 Colors

## seat/back

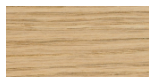

wood  
blanch oak  
1 Colors

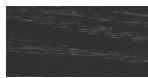

wood  
black open pore  
1 Colors

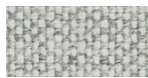

fabric  
Hallingdal 65  
47 Colors



fabric  
Canvas 2  
40 Colors



fabric  
Steelcut Trio 3  
48 Colors

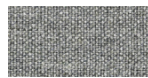

fabric  
Remix 2  
24 Colors



fabric  
Clara 2  
24 Colors



fabric  
Fiord  
24 Colors



fabric  
Divina MD  
24 Colors



fabric  
Divina Melange 2  
24 Colors



fabric  
Tonica 2  
39 Colors

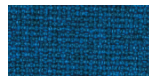

fabric  
Medley  
37 Colors

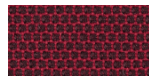

fabric  
Swing  
24 Colors

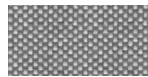

fabric  
Maya  
43 Colors



fabric  
Jet  
44 Colors



fabric  
Laser J Flash  
24 Colors



ecoleather  
GRIMM FR  
24 Colors

**consult the portfolio for the range of colors, fabrics, eco-leather, soft-leather.**

## use and maintenance instructions

Clean all parts in wood, leather, fabric and metal with a damp cloth or a diluted neutral cleaner. Do not use cleaners with alcohol, bleach, solvent or abrasive products. Any liquid spilt on the product must be wiped up immediately. When lifting or moving the product, hold it on the structure and not under the seat. The product should not be subjected to unbalanced weights, as it is designed for a proper rest on the foothold (on four legs or on the base). Our company relieves from any responsibility in case of damage caused to fragile floors. Avoid any improper use of the product: do not step on the product, on the footrest or on the armrests. Avoid any movements that could compromise the proper functionality of the product or the safety of the users. Wood and leather, being natural materials, could be easily damaged. Small impurities or imperfections are within quality standard range. Do not expose the product to weather conditions or atmospheric agents, nor to heat sources over 40°C. Also products for outdoor use could be afflicted by atmospheric agents. The product could undergo possible exterior changes due to particular exposure to heat, humidity and saltiness. An appropriate and frequent maintenance and cleaning of the product enhances its durability. The product could change colour and shade, if exposed to direct sunlight. Maintenance has to be carried out by experienced staff. Dispose of the package only after assembling the product, in order to avoid the loss of ironmongery and components. Once the product has been dismantled, the product itself or its components must be given to the public garbage disposal system, according to the legislation in force.