

Tolomeo Micro Table - Glossy white - Body Lamp



IP20     

DESIGN BY

Michele De Lucchi, Giancarlo Fassina

DESCRIPTION

Base and cantilevered arms in polished aluminium; diffuser in matt anodised aluminium; joints and supports in polished aluminium. System of spring balancing. The code is referred to the body lamp only

TECHNICAL DRAWINGS

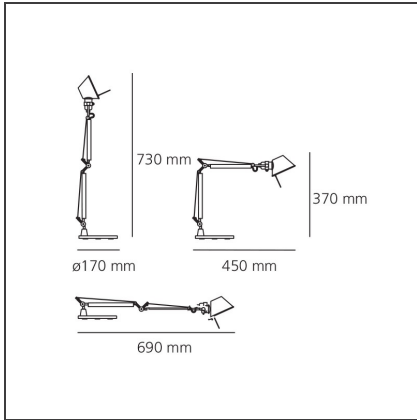

FEATURES

Article Code:	0010920A	Material:	Aluminium, steel
Colour:	Glossy white	Series:	Design
Installation:	Table		

DIMENSIONS

Length:	cm 45	Max Extension Length:	cm 69
Height:	cm 37		
Base Diameter:	cm 17		
Max Extension Height:	cm 73		

NOT INCLUDED SOURCES

Category:	HALO	Color Rendering:	1a
Number:	1	Color temperature (K):	3000K
Watt:	46W		
Lbs:	Qt26		
Socket:	E14		

ALTERNATIVE SOURCES

Category:	LED
Number:	1
Watt:	4W
Type:	2
Socket:	E14
Class:	A

LUMINAIRE

Watt:	40W	Delivered lumens output (lm):	244lm
Voltage:	220V-240V	CCT:	0K
		Efficiency:	57%
		Efficacy:	6.1lm/W
		CRI:	100

Notes

Interchangeable support: table base, clamp, desk fixed support and twin support that allows two independent lamp units to be fitted. Possibility to mount LED source on E14 Socket. Complete lamp consists of body lamp + accessories

ACCESSORIES

TOLOMEO
MORSETTO
A004100



TOLOMEO
SUPP.TAVOLO
FISSO
A004200