

# MATTER



cantarutti



Indice delle categorie Product categories index	25
Informazioni tecniche Technical information	353
Materiali e finiture Materials and finishes	412

A	Arco	52
B	Baba	90
C	Coco	140
	Cori	206
D	Dixie	286
F	Fly	184
	Frida	254
H	Hart	244
	Hyppo	170
I	Inga	318
K	Karma	300
L	Lea	310
M	Maki	26
N	Nika	222
O	Obi	194
P	Palmo	150
R	Ribbon	60
S	Seeli	324
	Sprint	80
	Stilo	232
T	Timber	276
	Tipi	124
	Tuilli	108
V	Viki	292
W	Why	268
Y	Yumi	42

## Outdoor

B	Baba	344
C	Coco	334



## WE GROW

La nostra storia è il risultato di una evoluzione iniziata nel 1970, nel mercato della produzione di sedute e complementi d'arredo in legno esportati in tutto il mondo, e continua con le generazioni più giovani della famiglia, che decidono di prediligere l'aspetto artigianale, costruttivo, creativo. La passione per il progetto prevale e negli anni duemila inizia la trasformazione. Verso l'obiettivo di dare forma a idee proprie, per trasmettere una visione personale del design, il proprio modo di concepire una seduta. Con un'esperienza professionale d'avanguardia non comune e un autentico amore per il prodotto. Un nuovo stabilimento indipendente, che racchiude l'impegno di una famiglia estimatrice del legno e del design. Cantarutti diventa brand. Progetta e realizza prodotti di design e li esporta in tutto il mondo con il proprio marchio. Passato e presente si uniscono per disegnare insieme il futuro di un nome nuovo.

Our story is the result of an evolution that began in 1970, producing wooden seats and furniture for export all over the world. We continue the story with the younger generations of the family, who develop the focus on the craftsmanship, construction and creative elements. The passion for the project prevails and in the 2000s the transformation begins. Towards the goal of giving shape to our own ideas, to convey a personal vision of design, our conception of a seat. With an uncommon, avant-garde and professional experience and an authentic love for the product. A new independent plant, which encompasses the commitment of a family who appreciates wood and design. Cantarutti becomes a brand. Designing and manufacturing design products, exported all over the world. Past and present combine to draw the future of a new name.

I nostri prodotti sono fatti in Italia e tutto il processo di produzione – prototipazione, lavorazione, assemblaggio, verniciatura e tappezzeria – si svolge nella nostra sede.

Our products are made in Italy and the whole production process – prototyping, processing, assembling, staining, polishing and upholstering – takes place in our factory.

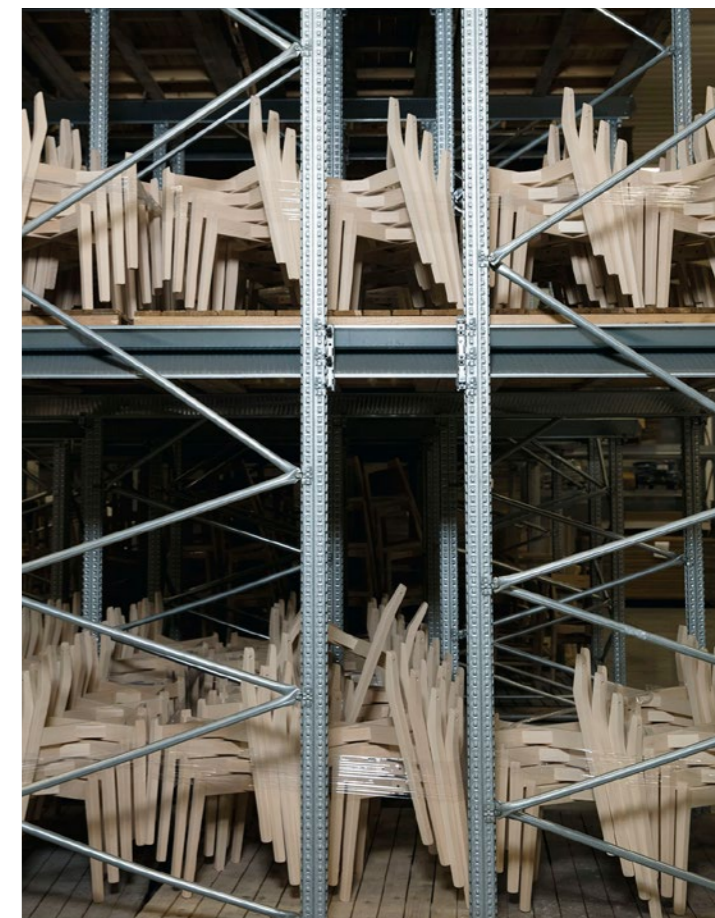

Nel nostro magazzino sono sempre disponibili migliaia di pezzi al grezzo, pronti per essere lavorati e personalizzati in base alle esigenze. Tutte le nostre sedie sono certificate CATAS per la sicurezza, la resistenza e la durata, mentre i modelli sono registrati con brevetto ornamentale, che tutela i disegni contro le copie e le contraffazioni.

Thousands of raw pieces are always available in our warehouse, ready to be processed and customised according to requirements. All our chairs are CATAS certified for safety, strength and durability, while the models are registered with an ornamental patent, which protects the designs against copies and counterfeits.





Abbiamo investito in macchinari all'avanguardia e internalizzato una serie di operazioni per avere un maggiore controllo sul prodotto e poter offrire ai nostri clienti una garanzia di qualità in più.

We have invested in cutting-edge machinery and internalised a series of operations to have greater control over the product and to be able to offer our customers an additional guarantee of quality.



## WE THINK

La sedia è un oggetto indispensabile. Eppure per questo, spesso quasi scontato. Ma ci sono sedie e sedie. La costruzione di una scocca, la solidità delle gambe, il pregio del materiale, non sono fattori variabili. La qualità non può prescindere da una perfetta costruzione, da una accurata selezione dei materiali e da una premurosa cura delle finiture. Il disegno di una sedia per noi è il progetto di un incontro, di una relazione. Perché quell'oggetto farà quotidianamente parte della vita di qualcuno. Ci piace pensare alle nostre sedie utilizzate dalle persone. Espressione di un'idea di design rivolto all'individuo, esteticamente attraente, funzionalmente accogliente, partecipe di un attimo, di un incontro, di uno scambio. Perché l'oggetto sedia nasce dalla relazione e si esprime nella relazione. E noi la creiamo pensando a questo.

The chair is an indispensable object, and often almost obvious. But there are chairs and chairs. The construction of a shell, the solidity of the legs, the quality of the material are not variable factors. The quality cannot be separated from a perfect construction, from an accurate selection of materials and from a careful attention to the finishes. For us, the design of a chair is the project of a meeting, of a relationship. Because that object will be part of someone's life daily. We like to think about our chairs used by people. Expression of a design idea addressed to the individual, aesthetically attractive, functionally welcoming, participating in a moment, a meeting, an exchange. Because the chair object is born from the relationship and is expressed in the relationship. And we create it having this in mind.

RIBBON by Anderssen & Voll  
p. 60





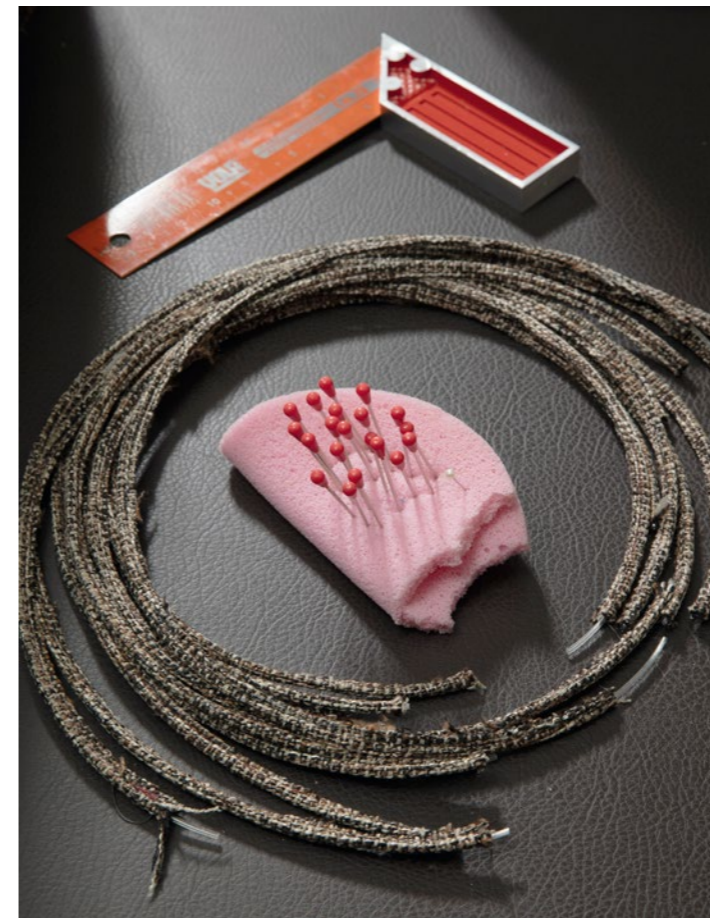
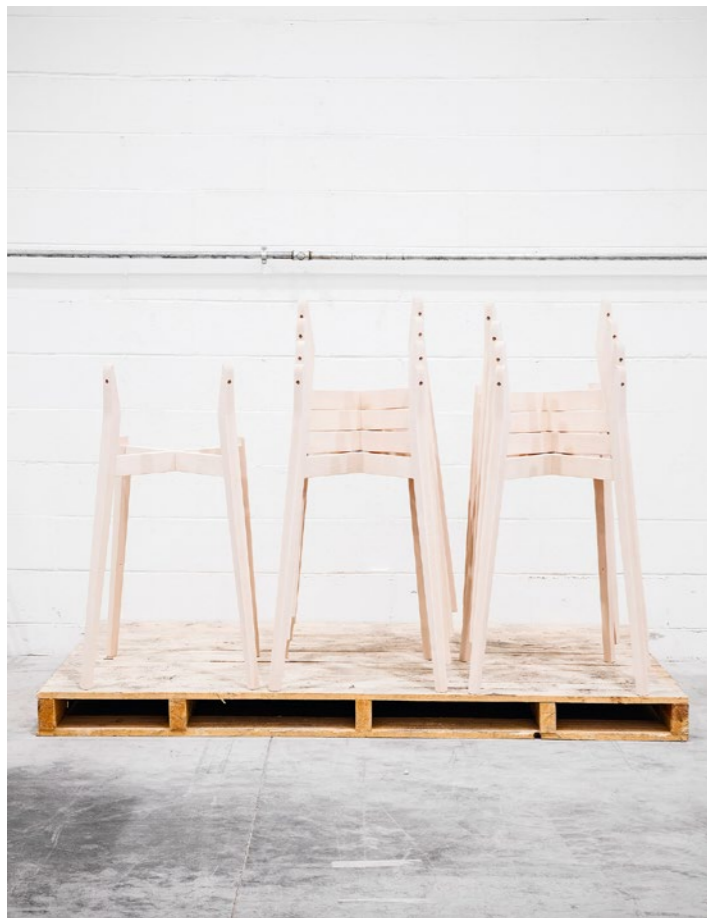

La filiera, dal progetto alla produzione, è controllata e realizzata nel nostro stabilimento. La passione, nel rispettare norme e persone, nel disegnare nuove idee, nel valorizzare la materia prima migliore. L'entusiasmo, la creatività e la professionalità connaturati al design e alla produzione italiana di qualità.

Il senso del fare. L'importanza della professionalità artigianale, in sinergia con la più avanzata innovazione tecnologica, sodalizio di tradizione e sviluppo. Il bello del fare. Il fascino di un'idea che rincorre un'immagine e quello della naturale trasformazione di un disegno in un modello.

The supply chain, from design to production, is controlled and implemented within our factory. The passion, in respecting rules and people, in designing new ideas, in enhancing the best raw material. The enthusiasm, creativity and professionalism inherent in Italian design and quality production.

The sense of doing. The importance of artisan professionalism, in synergy with the most advanced technological innovation, partnership of tradition and development. The beauty of doing. The charm of an idea that chases an image and that naturally transforms from a design into a model.

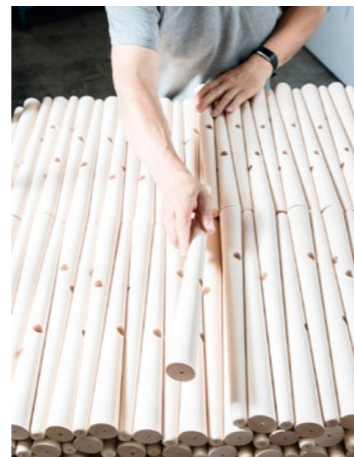

Lunghe scaffalature ospitano la catalogazione del pregiato archivio tessuti e i rotoli dei fili. Il reparto è allestito come un laboratorio sartoriale, con macchine di ultima generazione e cartamodelli su misura. La precisione e la cura del dettaglio offrono una finitura artigianale di massima qualità.

Long shelving houses our catalogues of the precious fabric archive and rolls of threads. The department is set up as a tailoring workshop, with the latest generation of machines and tailor-made patterns. The precision and attention to detail offer a top quality handcrafted finish.

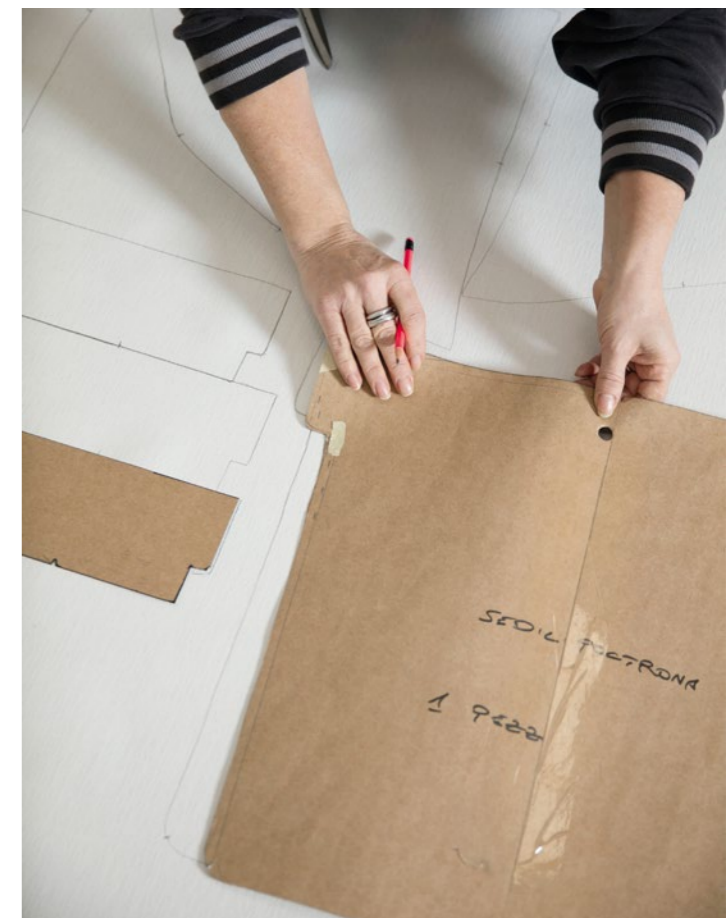



## WE MAKE

Facciamo prodotti di design. Con cura, qualità, innovazione. Ispirati dalla luce e dalla natura, dalla quale viene la più importante materia prima che lavoriamo. Il legno più selezionato, con il profumo e le venature delle migliori essenze. E poi metallo, personalizzato in qualsiasi colore. Concepiamo la produzione di una sedia come quella di un abito, con un laboratorio di tappezzeria dedicato appositamente ai rivestimenti. Ci piace fare le cose bene, sempre.

We make design products. With care, quality and innovation. Inspired by light and nature, from which the most important raw material we work comes from. The carefully selected wood, with the scent and grain of the best essences. And then metal, customised in any colour. We conceive the production like that of a dress, with a tailoring workshop dedicated specifically to the upholstery. We like to do things well, always.

Scopri la gamma di materiali e finiture  
Discover our materials and finishes  
➤ p. 412







Nello stabilimento si svolge gran parte del processo produttivo, grazie all'elevato know-how del reparto prototipazione interno, che supporta la progettazione e la successiva fase di produzione. Il progetto creativo diventa prototipo e viene sottoposto ai test di durata e tenuta CATAS. Successivamente, la lavorazione su grande scala è affidata a macchine a controllo numerico di ultima generazione; il prodotto viene poi trasferito nel reparto assemblaggio e infine collocato nel magazzino. Catalogate e ordinate come un'immensa biblioteca, dalle corsie odorose di essenze di legno, migliaia di sedie allo stadio grezzo sono a disposizione, pronte per essere finite secondo le specifiche dei clienti.

A large part of the production process takes place in the factory, thanks to the expertise of the internal prototyping department, which supports the design and the subsequent production phase. The creative project becomes a prototype and is subjected to CATAS durability and strength tests. Subsequently, large-scale processing is entrusted to the latest generation of numerical control machines; the product is then transferred to the assembly department and, once complete, is finally placed in the warehouse. Listed and ordered as an immense library, with wood-scented aisles, thousands of raw stage chairs are available, ready to be finished according to customer specifications.

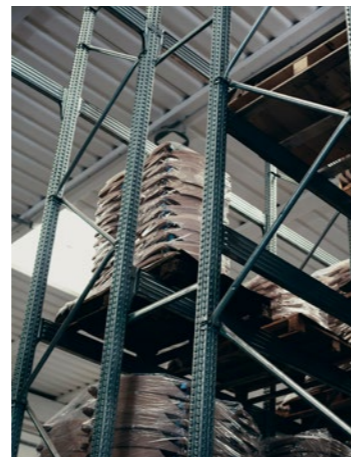

Grazie alla tecnologia all'avanguardia il nostro sofisticato impianto di verniciatura è uno dei più grandi in Europa, con una capacità produttiva di oltre 1.000 sedie al giorno, e garantisce una finitura di eccellenza.

Thanks to cutting-edge technology, our sophisticated staining system is one of the largest in Europe, with a production capacity of over 1,000 chairs per day, and guarantees an excellent finish.





## WE DESIGN

Quando si viene colpiti dalla bellezza di un oggetto capita di non sapere da dove nasca quell'attrazione. Appare, improvvisamente, e basta. Si percepisce, anche se non sempre si capisce. Il gusto è un fatto molto personale, ma l'idea del bello è qualcosa di indefinibilmente e tacitamente condiviso al di là di stili e categorie. La nostra idea di design riconosce alla creatività il potere di fare la differenza, di suscitare emozioni oltre la razionalità, pur comprese nella funzione del progetto. Le nostre collezioni sono disegnate con una cifra che crede principalmente nell'equilibrio delle forme e nella raffinatezza del particolare costruttivo. Una particolare capacità di interpretazione e soddisfazione delle esigenze architettoniche ed estetiche, ci riconosce un'intesa speciale con architetti e interior designer, che cercano un partner capace di trovare soluzioni. Fare bene una sedia significa anche saper spiegare esattamente come è costruita e poter progettare varianti o realizzare complessi particolari di finitura su ordinazione. Siamo fatti così, perfezionisti per vocazione. E i nostri prodotti sono come noi.

When you are struck by the beauty of an object it happens that you don't know where that attraction comes from. It appears suddenly, and that's it. It is perceived, even if it is not always understood. Taste is a very personal fact, but the idea of beauty is something indefinitely and tacitly shared beyond styles and categories. Our design idea recognises creativity the power to make a difference, to arouse emotions beyond rationality, even if included in the function of the project. Our collections are designed with a figure that mainly believes in the balance of shapes and refinement of the construction detail. A special ability to interpret and satisfy architectural and aesthetic needs recognises a special understanding with architects and interior designers who are looking for a partner capable of finding solutions. Making a chair well also means being able to explain exactly how it is built and being able to design variants or create complex special finishes to order. We are like this, perfectionists by vocation. And our products are like us.







L'impegno costante e l'attenzione per la qualità ci hanno garantito la certificazione ISO 9001:2015. Lavorando con il legno diamo la massima importanza al rispetto della natura, dell'ambiente e della sostenibilità. Per questo motivo utilizziamo esclusivamente legno che proviene da foreste gestite in maniera sostenibile certificate FSC® (Licence Code FSC-C130903) e PEFC. Avendo, inoltre, l'ambizione di migliorare sempre la nostra offerta, abbiamo ottenuto anche la certificazione di Responsabilità Sociale SA 8000:2014, e la certificazione del Sistema di Gestione Ambientale ISO 14001:2015.

The constant commitment and attention to quality have guaranteed us the ISO 9001:2015 certification. Working with wood, we give the utmost importance to respect for nature, the environment and sustainability. For this reason, we only use wood that comes from FSC® (Licence Code FSC-C130903) and PEFC certified sustainably managed forests. Since we have the ambition to constantly improve our offer, we have also obtained the SA 8000:2014 "Social Accountability Management System", and the ISO 14001:2015 "Environmental Management Systems" certification.

## MATTER

La materia lo è. Una questione di design. Reale, visibile. La forza di una linea è il risultato della materia plasmata a sua immagine.

Matter is a question of design. A question of real, visible design. The strength of a line is the result of matter moulded in its image.



Sprint ↗ p. 80



Si tocca. Si fa guardare. Ti cattura perché dà forma  
a un'astrazione, l'intangibile diventa tangibile.

You touch it. It draws your eye. It attracts you, giving shape  
to an abstraction, the intangible becomes tangible.







Ribbon ↗ p. 60



Palmo ↗ p. 150





Hyppo ↗ p. 170



La sostanza delle idee. L'essenza. La venatura. Il profumo.  
Una storia di materia e misura. Il design secondo Cantarutti.

The essence of ideas. The essence. The grain. The smell.  
A story of matter and measure. Design according to Cantarutti.



Stilo 7 p. 232

Indice delle categorie  
Product categories index

<b>Sedie</b> Chairs	52 Arco 90 Baba 140 Coco 286 Dixie 184 Fly 254 Frida 244 Hart 318 Inga 300 Karma 310 Lea 26 Maki 222 Nika 194 Obi 150 Palmo 60 Ribbon 324 Seeli 276 Timber 124 Tipi 108 Tuilli 292 Viki 268 Why 42 Yumi
------------------------	--

<b>Sedie impilabili</b> Stackables chairs	52 Arco 90 Baba 184 Fly 244 Hart 318 Inga 26 Maki 276 Timber 124 Tipi 42 Yumi
--	---

<b>Sedie girevoli</b> Swivel chairs	90 Baba 254 Frida 310 Lea 150 Palmo 60 Ribbon 232 Stilo
--	--

<b>Poltrone</b> Armchairs	140 Coco 206 Cori 286 Dixie 254 Frida 244 Hart 318 Inga 300 Karma 310 Lea 222 Nika 194 Obi 150 Palmo 60 Ribbon 324 Seeli 276 Timber 108 Tuilli 42 Yumi
------------------------------	---

<b>Poltrone impilabili</b> Stackable armchairs	244 Hart 318 Inga 26 Maki
---	---------------------------------

<b>Poltrone girevoli</b> Swivel armchairs	206 Cori 254 Frida 310 Lea 150 Palmo 60 Ribbon
--	--

<b>Sgabelli</b> Stools	52 Arco 90 Baba 140 Coco 286 Dixie 184 Fly 254 Frida 244 Hart 318 Inga 300 Karma 310 Lea 26 Maki 222 Nika 194 Obi 150 Palmo 60 Ribbon 324 Seeli 80 Sprint 276 Timber 124 Tipi 108 Tuilli 292 Viki 268 Why 42 Yumi
---------------------------	---

<b>Sgabelli impilabili</b> Stackable stools	90 Baba 344 Baba 124 Tipi
--	---------------------------------

<b>Sgabelli girevoli</b> Swivel stools	90 Baba 254 Frida 310 Lea 150 Palmo 60 Ribbon
---	---

<b>Pouf</b> Poufs	170 Hyppo
----------------------	-----------

<b>Lounge</b> Lounge chairs	140 Coco 206 Cori 254 Frida 170 Hyppo 232 Stilo 276 Timber 108 Tuilli
--------------------------------	---

<b>Lounge girevoli</b> Swivel lounge chairs	206 Cori 232 Stilo
--	-----------------------

<b>Bergère</b> Wingback chairs	254 Frida
-----------------------------------	-----------

<b>Ottoman</b> Ottomans	140 Coco 254 Frida 232 Stilo 108 Tuilli
----------------------------	--

<b>Divani</b> Sofas	140 Coco 254 Frida 170 Hyppo
------------------------	------------------------------------

<b>Panche</b> Benches	140 Coco 254 Frida 170 Hyppo 194 Obi 150 Palmo 124 Tipi
--------------------------	--

<b>Panche impilabili</b> Stackable benches	124 Tipi
---	----------

<b>Tavoli</b> Tables	170 Hyppo 124 Tipi 292 Viki
-------------------------	-----------------------------------

<b>Tavoli impilabili</b> Stackable tables	124 Tipi
--	----------

<b>Outdoor</b> Outdoor	344 Baba 334 Coco
---------------------------	----------------------



## MAKI by Adam Cornish

Forme esili e delicate delineano la silhouette di un oggetto di uso quotidiano, semplificato all'essenziale. Forme e materiali esaltano la struttura di questa famiglia di sedute, nata dalla collaborazione tra Cantarutti e il designer australiano Adam Cornish: Maki è un incontro di linee fluide che creano una perfetta armonia, un invito a sedersi per lasciarsi avvolgere dalla sua sinuosa leggerezza. È disponibile con fusto in metallo e sedile e schienale in legno. Il sedile è interamente personalizzabile nei colori e nei rivestimenti, in pelle o tessuto. Sedia e poltroncina, impilabili, si inseriscono con naturalezza in qualsiasi contesto. Lo sgabello rifinisce una collezione pensata per arredare spazi pubblici e privati con un'estetica riconoscibile e funzionale.

Categorie: sedia impilabile,  
poltrona impilabile, sgabello  
p. 376  
Informazioni tecniche

Slender and delicate shapes outline the silhouette of an everyday object, simplified to the essentials. Shapes and materials enhance the structure of this seating family, born from the collaboration between Cantarutti and the Australian designer Adam Cornish: Maki is a meeting of fluid lines that create perfect harmony, an invitation to sit and let yourself be enveloped by its sinuous lightness. Available with metal frame and wooden seat and back. The seat is fully customisable in colours and upholstery, in leather or fabric. Stackable chair and armchair fit naturally into any context. The stool finishes a collection designed to furnish public and private spaces with a recognisable and functional aesthetic.

Categorie: stackable chair,  
stackable armchair, stool  
p. 376  
Technical information



1.23.1/Z  
1.02.1/Z

- 1.23.1/Z Sedia impilabile con struttura in metallo, sedile e schienale in frassino, pannello sedile rivestito. — Stackable chair with metal frame, seat and back in ash, upholstered seat panel.
- 1.02.1/Z Sedia impilabile con struttura in metallo, sedile e schienale in frassino. — Stackable chair with metal frame, seat and back in ash.



- 1.02.1/Z Sedia impilabile con struttura in metallo, sedile e schienale in frassino. — Stackable chair with metal frame, seat and back in ash.





1.02.1/Z Sedia impilabile con struttura in metallo, sedile e schienale in frassino. — Stackable chair with metal frame, seat and back in ash.  
3.01.Z Sgabello con struttura in metallo, sedile rivestito e schienale in frassino. — Stool with metal frame, upholstered seat and back in ash.

3.23.Z Sgabello con struttura in metallo, sedile e schienale in frassino, pannello sedile rivestito. — Stool with metal frame, seat and back in ash, upholstered seat panel

1.23.1/Z Sedia impilabile con struttura in metallo, sedile e schienale in frassino, pannello sedile rivestito. — Stackable chair with metal frame, seat and back in ash, upholstered seat panel.

1.02.1/Z Sedia impilabile con struttura in metallo, sedile e schienale in frassino. — Stackable chair with metal frame, seat and back in ash.  
1.01.1/Z Sedia impilabile con struttura in metallo, sedile rivestito e schienale in frassino. — Stackable chair with metal frame, upholstered seat and back in ash.





1.23.1/Z

1.23.1/Z Sedia impilabile con struttura in metallo, sedile e schienale in frassino, pannello sedile rivestito. — Stackable chair with metal frame, seat and back in ash, upholstered seat panel.

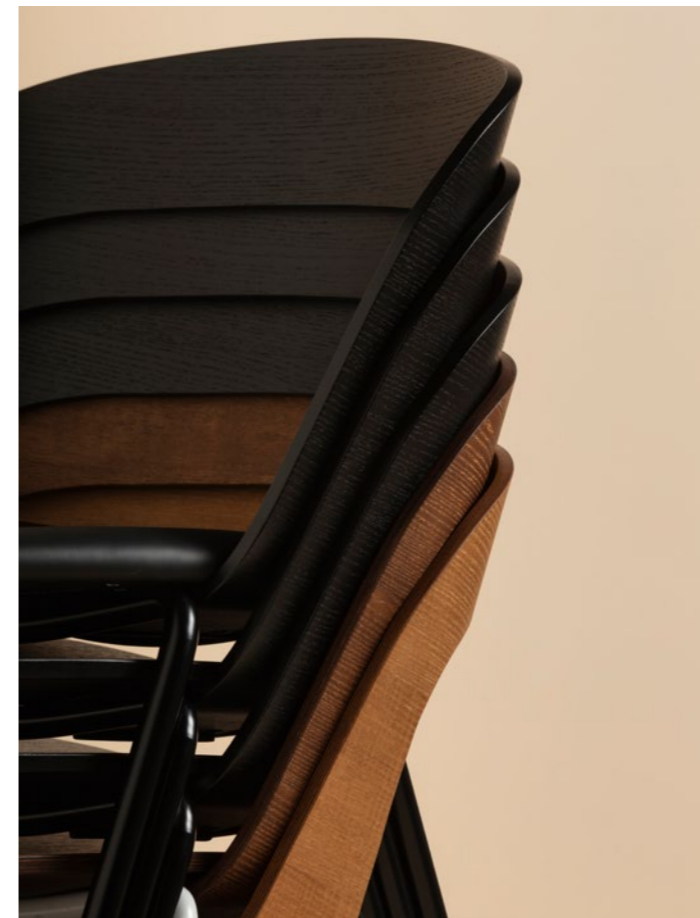

1.01.1/Z  
1.02.1/Z



1.01.1/Z  
1.02.1/Z

1.01.1/Z Sedia impilabile con struttura in metallo, sedile rivestito e schienale in frassino. — Stackable chair with metal frame, upholstered seat and back in ash.  
1.02.1/Z Sedia impilabile con struttura in metallo, sedile e schienale in frassino. — Stackable chair with metal frame, seat and back in ash.





1.01.1/Z  
1.23.1/Z

- 1.01.1/Z Sedia impilabile con struttura in metallo, sedile rivestito e schienale in frassino. — Stackable chair with metal frame, upholstered seat and back in ash.
- 1.23.1/Z Sedia impilabile con struttura in metallo, sedile e schienale in frassino, pannello sedile rivestito. — Stackable chair with metal frame, seat and back in ash, upholstered seat panel.

1.23.1/Z



1.02.1/Z



- 1.23.1/Z Sedia impilabile con struttura in metallo, sedile e schienale in frassino, pannello sedile rivestito. — Stackable chair with metal frame, seat and back in ash, upholstered seat panel.
- 1.02.1/Z Sedia impilabile con struttura in metallo, sedile e schienale in frassino. — Stackable chair with metal frame, seat and back in ash.





2.01.1/Z  
2.02.1/Z



2.01.1/Z



2.02.1/Z  
2.01.1/Z

2.01.1/Z Poltroncina impilabile con struttura in metallo, sedile rivestito e schienale in frassino. — Stackable armchair with metal frame, upholstered seat and back in ash.

2.02.1/Z Poltroncina impilabile con struttura in metallo, sedile e schienale in frassino. — Stackable armchair with metal frame, seat and back in ash.

2.02.1/Z Poltroncina impilabile con struttura in metallo, sedile e schienale in frassino. — Stackable armchair with metal frame, seat and back in ash.

2.01.1/Z Poltroncina impilabile con struttura in metallo, sedile rivestito e schienale in frassino. — Stackable armchair with metal frame, upholstered seat and back in ash.





3.01.Z  
3.23.Z

**ADAM CORNISH**  
Adam Cornish è un designer multidisciplinare che lavora dal suo studio di design indipendente a Melbourne, Australia. Adam mira a creare prodotti onesti e accessibili, sviluppati attraverso la ricerca e consentendo ai prodotti stessi di trovare la loro naturale espressione. Combinando soluzioni di design forti e semplici con una palette di materiali tattili naturali, Adam si impegna a creare prodotti unici dotati di longevità visiva e fisica.

Adam Cornish is a multidisciplinary designer working from his independent design studio in Melbourne, Australia. Adam aims to create honest accessible products developed through research and by allowing products to find their natural expression. By combining strong, simple design solutions with a palette of natural tactile materials, Adam strives to create individual products with visual and physical longevity.



- 3.01.Z Sgabello con struttura in metallo, sedile rivestito e schienale in frassino.  
— Stool with metal frame, upholstered seat and back in ash.
- 3.23.Z Sgabello con struttura in metallo, sedile e schienale in frassino, pannello sedile rivestito. — Stool with metal frame, seat and back in ash, upholstered seat panel.



3.23.Z

- 3.23.Z Sgabello con struttura in metallo, sedile e schienale in frassino, pannello sedile rivestito. — Stool with metal frame, seat and back in ash, upholstered seat panel.





3.14.Z  
2.01.I/Z

3.14.Z Sgabello con struttura in metallo, sedile e schienale in frassino. — Stool with metal frame, seat and back in ash.  
2.01.I/Z Poltroncina impilabile con struttura in metallo, sedile rivestito e schienale in frassino. — Stackable armchair with metal frame, upholstered seat and back in ash.



2.01.I/Z

2.01.I/Z Poltroncina impilabile con struttura in metallo, sedile rivestito e schienale in frassino. — Stackable armchair with metal frame, upholstered seat and back in ash.







## YUMI by Enzo Berti

Un classico senza tempo in grado di adattarsi al gusto e alle esigenze della contemporaneità. In Yumi, Enzo Berti ritrova il fascino di un design dall'eleganza garbata, in cui morbide curve diventano un dettaglio inedito per portare nuove forme espressive negli spazi pubblici e privati. Yumi conferisce un aspetto distintivo a qualsiasi contesto e situazione. In legno o nelle versioni imbottite, questa famiglia di sedute trova l'accostamento più adatto a ogni ambiente in un'ampia palette di tessuti e finiture, creando un abbraccio intimo e accogliente che non trascuri la funzionalità. La linea continua che accompagna lo schienale ai braccioli permette di appoggiare la poltrona sul piano del tavolo, la sedia impilabile consente di riorganizzare gli spazi con flessibilità e tempi ridotti.

Categorie: sedia impilabile,  
poltrona impilabile, sgabello  
↳ p. 407  
Informazioni tecniche

A timeless classic able to adapt to the taste and needs of the contemporary world. In Yumi, Enzo Berti rediscovers the charm of a design with a graceful elegance, in which soft curves become a detail never seen before, to bring new forms of expression to public and private spaces. Yumi gives a distinctive look to any context. In wood or upholstered versions, this family finds the most suitable combination for any environment in a wide palette of fabrics and finishes, creating an intimate and welcoming embrace that does not neglect functionality. The continuous line that accompanies the backrest to the armrests, allows you to place the armchair on the table top, the stackable chair allows you to reorganise spaces with flexibility and efficiency.

Categorie: stackable chair,  
stackable armchair, stool  
↳ p. 407  
Technical information



1.02.1  
3.14.0

- 1.02.1 Sedia impilabile con struttura, sedile e schienale in faggio.  
— Stackable chair with frame, seat and back in beech.  
3.14.0 Sgabello con struttura, sedile e schienale in faggio. — Stool with frame, seat and back in beech.



- 2.03.0 Poltroncina con struttura in faggio, sedile e schienale rivestiti.  
— Armchair with frame in beech, upholstered seat and back.





3.01.0 Sgabello con struttura in faggio,  
sedile rivestito. — Stool with frame  
in beech, upholstered seat.  
2.02.0 Poltroncina con struttura, sedile  
e schienale in faggio. — Armchair with  
frame, seat and back in beech.

2.01.0 Poltroncina con struttura in faggio,  
sedile rivestito. — Armchair with frame  
in beech, upholstered seat.  
1.01.I Sedia impilabile con struttura in faggio,  
sedile rivestito. — Stackable chair with  
frame in beech, upholstered seat.





1.01.I  
2.03.I

- 1.01.I Sedia impilabile con struttura in faggio, sedile rivestito. — Stackable chair with frame in beech, upholstered seat.  
2.03.I Poltroncina con struttura in faggio, sedile e schienale rivestiti. — Armchair with frame in beech, upholstered seat and back.



1.01.I  
1.02.I

- 1.01.I Sedia impilabile con struttura in faggio, sedile rivestito. — Stackable chair with frame in beech, upholstered seat.  
1.02.I Sedia impilabile con struttura, sedile e schienale in faggio. — Stackable chair with frame, seat and back in beech.





3.03.0  
3.14.0

**ENZO BERTI**  
Enzo Berti, veneziano, si è formato all'Accademia di Belle Arti. Da più di trent'anni collabora come industrial designer con grandi aziende italiane e internazionali.

Enzo Berti was born in Venice and studied at the Academy of Fine Arts. He is an industrial designer and has worked with well known Italian and international companies for over thirty years.



3.03.0 Sgabello con struttura in faggio, sedile e schienale rivestiti.  
— Stool with frame in beech, upholstered seat and back.  
3.14.0 Sgabello con struttura, sedile e schienale in faggio. — Stool with frame, seat and back in beech.

3.03.0



3.14.0



3.03.0 Sgabello con struttura in faggio, sedile e schienale rivestiti.  
— Stool with frame in beech, upholstered seat and back.  
3.14.0 Sgabello con struttura, sedile e schienale in faggio. — Stool with frame, seat and back in beech.







## ARCO

La collezione Arco nasce da uno studio di forme, proporzioni e dimensioni attentamente calibrate. Composta da sedia e sgabello, si distingue per lo schienale dalla forma curvata, che esce dal profilo della seduta, mantenendo una perfetta armonia nel suo insieme. Una lavorazione complessa che la rende leggera, ergonomica e solida al tempo stesso. La possibilità di imbottire schienale e seduta aggiunge comodità ed un tocco di raffinatezza. Semplice ma dalla grande personalità, la sedia Arco è impilabile, particolarmente adatta per a situazioni e contesti dove si desidera arredare con uno stile distintivo senza rinunciare alla praticità.

Categorie: sedia impilabile,  
sgabello  
↳ p. 353  
Informazioni tecniche

The Arco collection was born from a study of carefully calibrated shapes, proportions and dimensions. Composed of chair and stool, it is distinguished by the curved backrest, which rises from the seat profile, maintaining a perfect harmony. A complex process that makes it simultaneously light, ergonomic and solid. The possibility of padding the back and seat adds comfort and a touch of refinement. Simple but with great personality, the Arco chair is stackable, and particularly suitable for situations that call for a distinctive style without sacrificing practicality.

Categorie: stackable chair,  
stool  
↳ p. 353  
Technical information







3.03.0 Sgabello con struttura in faggio, sedile e schienale rivestiti. — Stool with frame in beech, upholstered seat and back.

1.01.I Sedia impilabile con struttura in faggio, sedile rivestito. — Stackable chair with frame in beech, upholstered seat.  
3.01.0 Sgabello con struttura in faggio, sedile rivestito. — Stool with frame in beech, upholstered seat.

1.03.I Sedia impilabile con struttura in faggio, sedile e schienale rivestiti. — Stackable chair with frame in beech, upholstered seat and back.  
1.02.I Sedia impilabile con struttura, sedile e schienale in faggio. — Stackable chair with frame, seat and back in beech.

Nella foto in versione opzionale bicolore. Image, optional two tone version.





1.02.I  
1.03.I

Nella foto in versione opzionale bicolore.  
Image, optional two tone version.

- 1.02.I Sedia impilabile con struttura, sedile e schienale in faggio. — Stackable chair with frame, seat and back in beech.
- 1.03.I Sedia impilabile con struttura in faggio, sedile e schienale rivestiti. — Stackable chair with frame in beech, upholstered seat and back.

1.02.I



1.03.I  
1.02.I



- 1.02.I Sedia impilabile con struttura, sedile e schienale in faggio. — Stackable chair with frame, seat and back in beech.
- 1.03.I Sedia impilabile con struttura in faggio, sedile e schienale rivestiti. — Stackable chair with frame in beech, upholstered seat and back.

Nella foto in versione opzionale bicolore.  
Image, optional two tone version.





1.03.I



1.02.I



1.01.I  
3.03.0

- 1.03.I Sedia impilabile con struttura in faggio, sedile e schienale rivestiti. — Stackable chair with frame in beech, upholstered seat and back.
- 1.02.I Sedia impilabile con struttura, sedile e schienale in faggio. — Stackable chair with frame, seat and back in beech.

- 1.01.I Sedia impilabile con struttura in faggio, sedile rivestito. — Stackable chair with frame in beech, upholstered seat.
- 3.03.0 Sgabello con struttura in faggio, sedile e schienale rivestiti. — Stool with frame in beech, upholstered seat and back.

Nella foto in versione opzionale bicolore.  
Image, optional two tone version.



## RIBBON by Anderssen & Voll

Comfort ed ergonomia contraddistinguono la collezione Ribbon disegnata dal duo norvegese Anderssen & Voll. Un sinuoso gioco di pieni e vuoti, privo di svolte inaspettate, crea un perfetto equilibrio fatto di proporzioni armoniose che sembrano nascere da un'idea di perfezione. Un accurato studio di forme e dimensioni declina uno stile preciso e riconoscibile in diverse soluzioni adattabili a più spazi e contesti. Proporzioni e dimensioni declinate in diverse soluzioni all'insegna della massima versatilità. La scocca di sedia e sgabello presenta una doppia curva, delineando una fluida continuità di superfici, mentre lo schienale della poltrona configura la comodità di un sostegno avvolgente. Le gambe, dalla sagoma morbida e arrotondata, leggere e dinamiche, si sposano armonicamente con la sinuosità della seduta. L'ecclettica famiglia Ribbon coniuga design, funzionalità e dettagli raffinati per arredare ogni genere di interno.

Comfort and ergonomics distinguish the Ribbon collection designed by the Norwegian duo Anderssen & Voll. A sinuous game of solids, voids, and fluid intuitive turns, create an ideal balance of harmonious proportions that seem to arise from an idea of perfection. A careful study of shapes and sizes defines a precise and recognisable style in different solutions, adaptable to multiple spaces and contexts. Proportions and dimensions defined in different solutions in the name of maximum versatility. The shell of the stool and chair is shaped and curved on two planes, outlining a fluid continuity of surfaces, while the back of the armchair configures the comfort of an enveloping support. The legs, with a soft and rounded shape, light and dynamic, blend harmoniously with the sinuosity of the seat. The eclectic Ribbon family combines design, functionality and refined details to furnish any interior.



Categorie: sedia, sedia girevole, poltrona, poltrona girevole, sgabello, sgabello girevole e regolabile  
↳ p. 383  
Informazioni tecniche

Categorie: chair, swivel chair, armchair, swivel armchair, stool, swivel and adjustable stool  
↳ p. 383  
Technical information

2.34.0 Poltrona con struttura in faggio, scocca rivestita. — Armchair with frame in beech, upholstered shell.



1.34.0 Sedia con struttura in faggio, scocca rivestita. — Chair with frame in beech, upholstered shell.





1.37.0 Sedia con struttura e scocca  
in faggio, pannello sedile rivestito.  
— Chair with frame and shell  
in beech, upholstered seat panel.

1.32.0 Sedia con struttura e scocca  
in faggio, rivestimento frontale.  
— Chair with frame and shell  
in beech, upholstered shell pad.  
1.31.0 Sedia con struttura e scocca  
in faggio. — Chair with frame  
and shell in beech.

3.36.0 Sgabello con struttura e scocca in faggio.  
— Stool with frame and shell in beech.  
3.32.0 Sgabello con struttura e scocca in faggio,  
rivestimento frontale. — Stool with frame  
and shell in beech, upholstered shell pad.

2.35.0 Poltrona con struttura e scocca  
in faggio, pannello sedile rivestito.  
— Armchair with frame and shell  
in beech, upholstered seat panel.





1.35.Z

**ANDERSSEN & VOLL**  
 Anderssen & Voll è uno studio di design di Oslo guidato da Torbjørn Anderssen ed Espen Voll. Nato nel 2009, lo studio ha seguito progetti per alcuni dei più importanti brand europei, operando in vari campi del design con un'attenzione particolare per gli oggetti domestici.

Anderssen&Voll is an Oslo design firm headed by Torbjørn Anderssen and Espen Voll. Established in 2009, for several years it worked on projects for some of the top European brands, working within various fields of design but focused on the domestic objects.



1.35.Z Sedia con struttura in metallo, scocca in faggio, pannello sedile rivestito.  
 — Chair with metal frame, shell in beech, upholstered seat panel.



1.30.Z  
 1.38.Z

1.30.Z Sedia con struttura in metallo, scocca rivestita. — Chair with metal frame, upholstered shell.  
 1.38.Z Sedia con struttura in metallo, scocca in faggio, rivestimento frontale. — Chair with metal frame, shell in beech, upholstered shell pad.





1.32.Z



3.38.Z  
1.32.Z



1.34.0

- 1.32.Z Sedia con struttura in metallo, scocca in faggio, rivestimento frontale.  
— Chair with metal frame, shell in beech, upholstered shell pad.
- 3.38.Z Sgabello con struttura in metallo, scocca in faggio, rivestimento frontale.  
— Stool with metal frame, shell in beech, upholstered shell pad.

- 1.34.0 Sedia con struttura in faggio, scocca rivestita. — Chair with frame in beech, upholstered shell.





1.36.0

1.36.0 Sedia con struttura e scocca in faggio. — Chair with frame and shell in beech.



2.38.Z

2.38.Z Poltrona con struttura in metallo, scocca in faggio, rivestimento frontale. — Armchair with metal structure, shell in beech, upholstered shell pad.



2.38.Z





B.34.0



B.34.0

B.34.0 Poltrona girevole con struttura in metallo, scocca rivestita.  
— Swivel armchair with metal frame, upholstered shell.

B.34.0 Poltrona girevole con struttura in metallo, scocca rivestita.  
— Swivel armchair with metal frame, upholstered shell.





2.36.Z  
2.36.0

2.36.Z Poltrona con struttura in metallo, scocca in faggio. — Armchair with metal frame, shell in beech.  
2.36.0 Poltrona con struttura e scocca in faggio. — Armchair with frame and shell in beech.



3.37.0  
3.36.0  
3.31.0

3.37.0 Sgabello con struttura e scocca in faggio, pannello sedile rivestito. — Stool with frame and shell in beech, upholstered seat panel.  
3.36.0 Sgabello con struttura e scocca in faggio. — Stool with frame and shell in beech.

3.31.0 Sgabello con struttura e scocca in faggio. — Stool with frame and shell in beech.





3.32.Z  
3.35.Z

- 3.32.Z Sgaballo con struttura in metallo, scocca in faggio, rivestimento frontale. — Stool with metal frame, shell in beech, upholstered shell pad.
- 3.35.Z Sgaballo con struttura in metallo, scocca in faggio, pannello sedile rivestito. — Stool with metal frame, shell in beech, upholstered seat panel.



C.35.0/R



C.35.0/R  
C.37.0/R

- C.35.0/R Sgaballo girevole e regolabile con struttura in metallo, scocca in faggio, pannello sedile rivestito. — Swivel and adjustable stool with metal frame, shell in beech, upholstered seat panel.
- C.37.0/R Sgaballo girevole e regolabile con struttura in metallo, scocca in faggio, pannello sedile rivestito. — Swivel and adjustable stool with metal frame, shell in beech, upholstered seat panel.

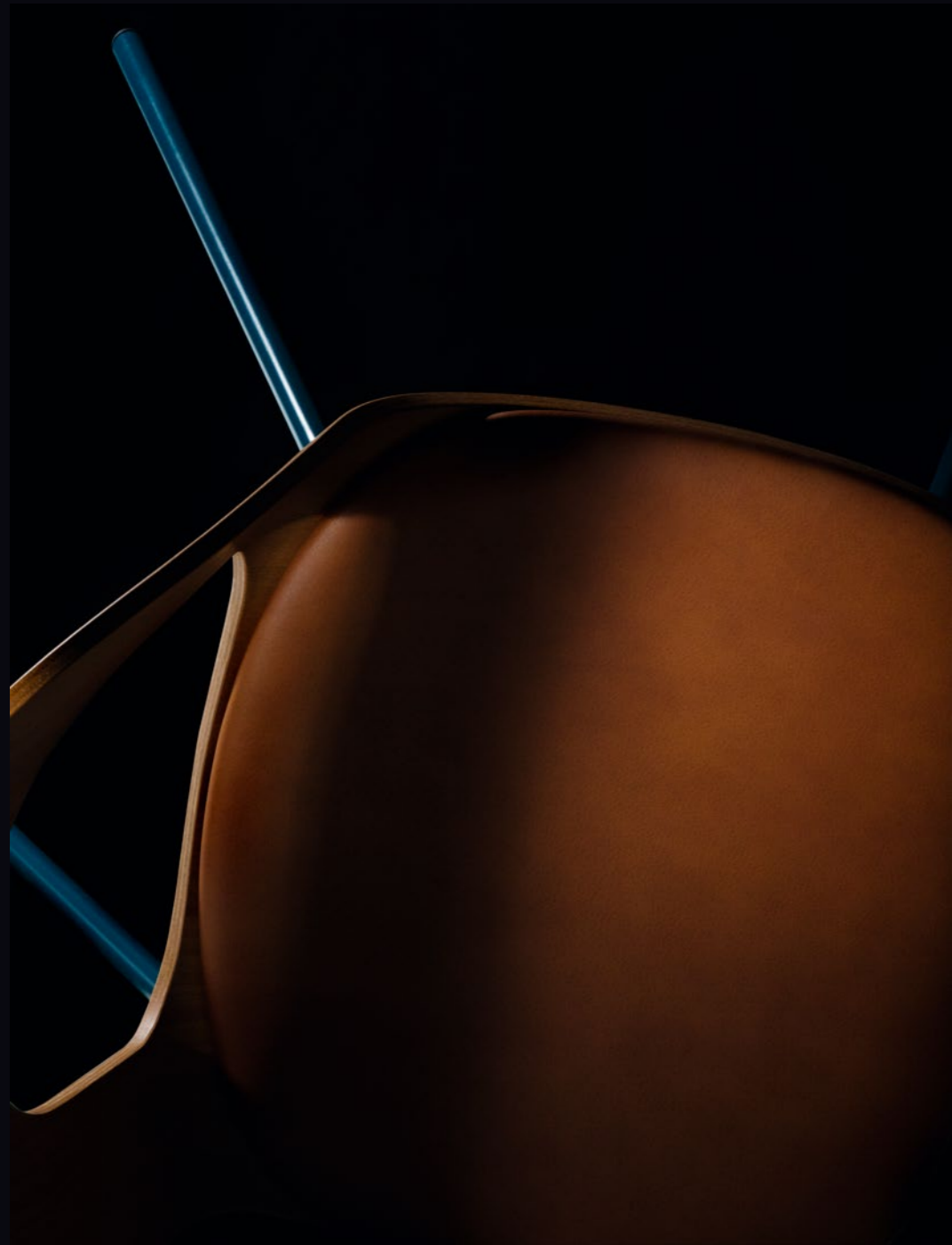



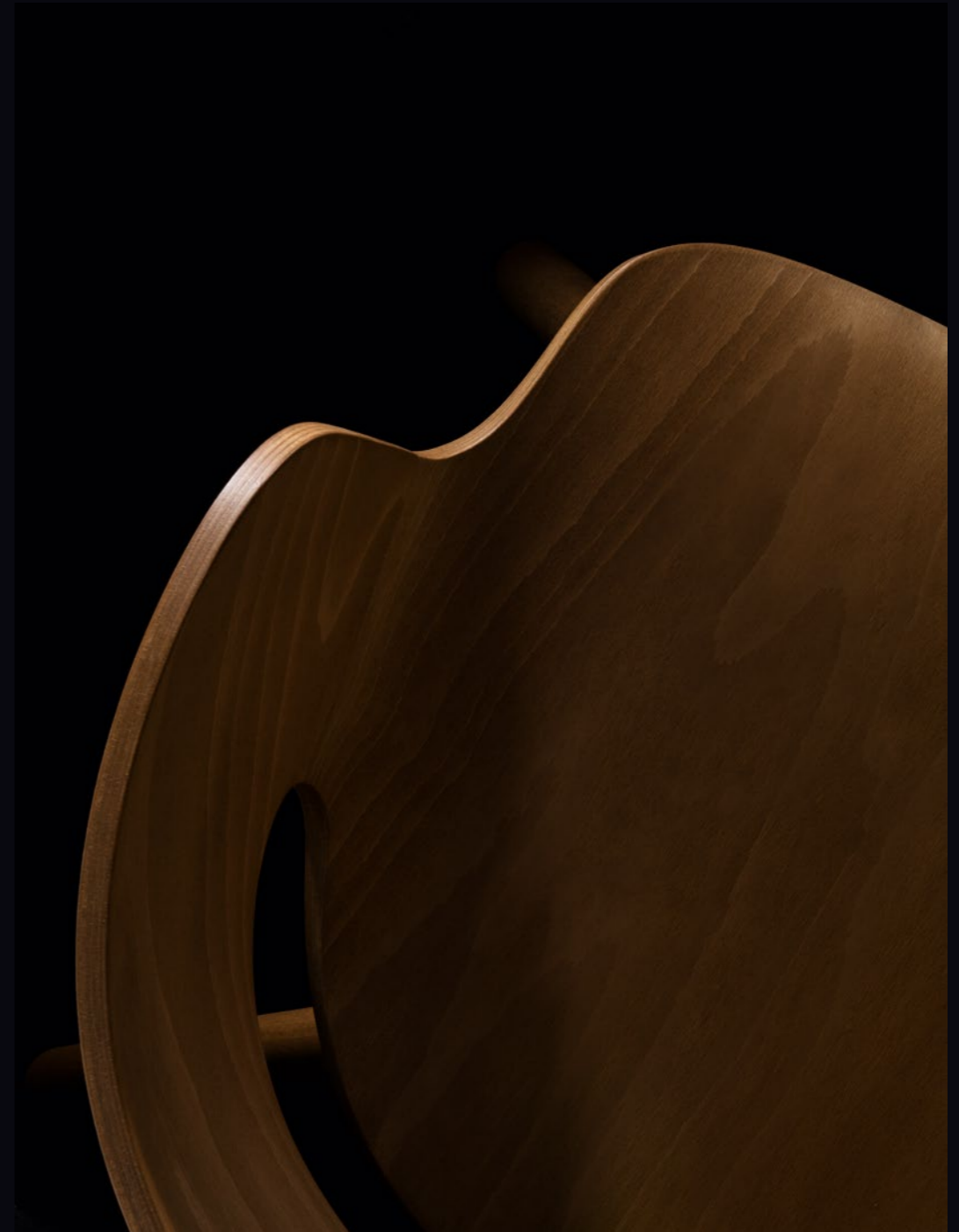

## SPRINT by Studio Klass

Un design giovane e contemporaneo suggerito da una vecchia slitta. Sprint è lo sgabello progettato da Studio Klass che coniuga un'estetica distintiva a una grande leggerezza visiva. Linee decise e scorrevoli si alternano ad altre, più morbide e sinuose, andando a comporre elementi essenziali dai bordi accuratamente rifiniti. La curvatura delle gambe posteriori, creata da un unico elemento, diventa espressione di una rara abilità artigiana che trova nuova forza espressiva nelle più moderne tecnologie produttive. Sprint si presta ad infondere uno spirito dinamico ai momenti conviviali di ogni giorno, a casa o nei locali pubblici. La struttura, realizzata in frassino, è proposta in tre diverse altezze. Una grande varietà di finiture va a personalizzare la seduta in legno: disponibile anche imbottita e rivestita in pelle o tessuto, contribuisce a sottolineare un carattere vivace e funzionale.

A young and contemporary design inspired by a vintage sled. Sprint is the stool designed by Studio Klass that combines a distinctive aesthetic with great visual lightness. Sharp and flowing lines alternate with others, softer and more sinuous, composing essential elements with carefully finished edges. The curvature of the rear legs, created from a single element, becomes the expression of a rare craftsmanship that finds new expressive force in the most modern production technologies. Sprint lends itself to instilling a dynamic spirit in everyday convivial moments, at home or in public places. The structure, made of ash, is proposed in three different heights. A great variety of finishes personalise the wooden seat: padded and upholstered in leather or fabric underlining a lively and functional character.



Categoria: sgabello  
p. 392  
Informazioni tecniche

Category: stool  
p. 392  
Technical information

3.18.A Sgabello con struttura in frassino, pannello sedile rivestito.  
— Stool with frame in ash, upholstered seat panel.



3.18.A Sgabello con struttura in frassino, pannello sedile rivestito.  
— Stool with frame in ash, upholstered seat panel.





3.17.B Sgabello con struttura e sedile in frassino. — Stool with frame and seat in ash.  
3.17.A Sgabello con struttura e sedile in frassino. — Stool with frame and seat in ash.

3.18.B Sgabello con struttura in frassino, pannello sedile rivestito. — Stool with frame in ash, upholstered seat panel.

3.18.A Sgabello con struttura in frassino, pannello sedile rivestito. — Stool with frame in ash, upholstered seat panel.



3.18.A

3.18.A Sgabello con struttura in frassino, pannello sedile rivestito.  
— Stool with frame in ash, upholstered seat panel.



3.18.A



3.18.A Sgabello con struttura in frassino, pannello sedile rivestito.  
— Stool with frame in ash, upholstered seat panel.





3.18.B  
3.17.B  
3.17.A

**STUDIO KLASS**

Marco Maturo e Alessio Roscini nel 2009 fondano Studio Klass, realtà che si occupa principalmente di industrial design con sede a Milano. Lo studio opera in diversi settori, dal furniture al product design, e nel tempo ha stretto importanti collaborazioni con aziende italiane ed internazionali, presentando progetti durante numerose fiere ed eventi tra cui Milano, Parigi e New York.

In 2009 Marco Maturo and Alessio Roscini founded Studio Klass, an industrial design agency based in Milan. The studio operates in several areas, from furniture to product design and, over the years, has worked with Italian and international well-known companies, presenting its products during many design fairs and events in Milan, Paris and New York.



3.18.B Sgabello con struttura in frassino, pannello sedile rivestito.  
— Stool with frame in ash, upholstered seat panel.

3.17.B Sgabello con struttura e sedile in frassino. — Stool with frame and seat in ash.

3.17.A Sgabello con struttura e sedile in frassino.  
— Stool with frame and seat in ash.



3.18.A

3.18.A Sgabello con struttura in frassino, pannello sedile rivestito.  
— Stool with frame in ash, upholstered seat panel.





## BABA

Una scocca sinuosa che si apre a sorprendenti possibilità di personalizzazione. Dalle calde sfumature del legno a morbide pelli e resistenti tessuti, disponibili in un'ampia gamma di texture e colori, Baba permette di creare esclusive combinazioni per infondere un tocco personale e distintivo a qualsiasi ambiente. Baba è una collezione trasversale e articolata che arreda spazi pubblici e privati con soluzioni configurabili in base a specifiche esigenze. La scocca in faggio poggia su una struttura in legno o metallo, che può essere anche agganciabile e impilabile per una riorganizzazione pratica e flessibile degli spazi.

A sinuous shell that reveals surprising possibilities of customisation. From the warm shades of wood to soft leathers and durable fabrics, available in a wide range of textures and colours, Baba allows you to create exclusive combinations, infused with personal and distinctive style. Baba is a transversal and articulated collection designed to furnish public and private spaces with configurable solutions based on specific needs. The wooden shell rests on a wooden or metal structure, which can also be linked and stacked for a practical and flexible reorganisation of layouts.



1.31.ZS/I  
1.30.ZS/I

Categorie: sedia, sedia impilabile, sedia girevole, sedia girevole con rotelle, sgabello, sgabello impilabile, sgabello girevole e regolabile  
↳ p. 354  
Informazioni tecniche

Categorie: chair, stackable chair, swivel chair, swivel chair with castors, stool, stackable stool, swivel and adjustable stool  
● Stackable  
↳ p. 354  
Technical information

1.31.ZS/I Sedia impilabile con struttura in metallo, scocca in faggio. — Stackable chair with metal frame, shell in beech.  
1.30.ZS/I Sedia impilabile con struttura in metallo, scocca rivestita. — Stackable chair with metal frame, upholstered shell.



1.31.ZS/I Sedia impilabile con struttura in metallo, scocca in faggio. — Stackable chair with metal frame, shell in beech.



3.30.0 Sgabello con struttura in faggio, scocca rivestita. — Stool with frame in beech, upholstered shell.

1.37.0 Sedia con struttura e scocca in faggio, pannello sedile rivestito. — Chair with frame and shell in beech, upholstered seat panel.  
1.31.0 Sedia con struttura e scocca in faggio. — Chair with frame and shell in beech.

1.30.Z/1 Sedia impilabile con struttura in metallo, scocca rivestita. — Stackable chair with metal frame, upholstered shell.  
1.37.Z/1 Sedia impilabile con struttura in metallo e scocca in faggio, pannello sedile rivestito. — Stackable chair with metal frame and shell in beech, upholstered seat panel.

3.31.ZS/1 Sgabello impilabile con struttura in metallo, scocca in faggio. — Stackable stool with metal frame, shell in beech.





1.31.ZS/1

Nella foto in versione con gancio opzionale.  
Image, in optional version with linking.

1.31.ZS/1 Sedia impilabile con struttura in metallo,  
scocca in faggio. — Stackable  
chair with metal frame, shell in beech.



1.31.ZS/1



1.37.Z/1

1.31.ZS/1 Sedia impilabile con struttura in metallo,  
scocca in faggio. — Stackable  
chair with metal frame, shell in beech.  
1.37.Z/1 Sedia impilabile con struttura in metallo  
e scocca in faggio, pannello sedile  
rivestito. — Stackable chair with metal  
frame and shell in beech, upholstered  
seat panel.



1.31.Z/1

1.31.Z/1 Sedia impilabile con struttura in metallo, scocca in faggio. — Stackable chair with metal frame, shell in beech.



3.37.Z

3.37.Z Sgabello con struttura in metallo e scocca in faggio, pannello sedile rivestito. — Stool with metal frame and shell in beech, upholstered seat panel.  
3.31.ZS/1 Sgabello impilabile con struttura in metallo, scocca in faggio. — Stackable stool with metal frame, shell in beech.



3.37.Z  
3.31.ZS/1





A.30.0  
A.37.0

- A.30.0 Sedia girevole con struttura in metallo, scocca rivestita. — Swivel chair with metal frame, upholstered shell.
- A.37.0 Sedia girevole con struttura in metallo e scocca in faggio, pannello sedile rivestito. — Swivel chair with metal frame and shell in beech, upholstered seat panel.



A.37.0

- A.37.0 Sedia girevole con struttura in metallo e scocca in faggio, pannello sedile rivestito. — Swivel chair with metal frame and shell in beech, upholstered seat panel.



C.30.0/R  
C.37.0/R

- C.30.0/R Sgabello girevole e regolabile, con struttura in metallo e scocca in faggio rivestita. — Swivel and adjustable stool, with metal frame, upholstered shell.
- C.37.0/R Sgabello girevole e regolabile, con struttura in metallo e scocca in faggio, pannello sedile rivestito. — Swivel and adjustable stool, with metal frame, shell in beech, upholstered seat panel.



C.37.0/R



C.37.0/R

- C.37.0/R Sgabello girevole e regolabile, con struttura in metallo e scocca in faggio, pannello sedile rivestito. — Swivel and adjustable stool, with metal frame, shell in beech, upholstered seat panel.





1.31.0  
1.37.0



1.31.0  
1.37.0



1.37.0

1.31.0 Sedia con struttura e scocca in faggio.  
— Chair with frame and shell in beech.  
1.37.0 Sedia con struttura e scocca in faggio,  
pannello sedile rivestito. — Chair with  
frame and shell in beech, upholstered  
seat panel.

1.37.0 Sedia con struttura e scocca in faggio,  
pannello sedile rivestito. — Chair with  
frame and shell in beech, upholstered  
seat panel.



3.30.0  
1.30.0

3.30.0 Sgabello con struttura in faggio,  
scocca rivestita. – Stool with  
frame in beech, upholstered shell.  
1.30.0 Sedia con struttura in faggio,  
scocca rivestita. – Chair with  
frame in beech, upholstered shell.

1.30.0



3.30.0



1.30.0 Sedia con struttura in faggio,  
scocca rivestita. – Chair with  
frame in beech, upholstered shell.  
3.30.0 Sgabello con struttura in faggio,  
scocca rivestita. – Stool with  
frame in beech, upholstered shell.





## TUILLI by Andrea Steidl

Tuilli estende il concetto di calda e ricercata accoglienza a forme morbide e avvolgenti. Sagome generose si accompagnano a volumi di diverse dimensioni che colpiscono per un'estetica riconoscibile, legata a un elegante equilibrio tra classico e moderno. Numerosi elementi si incontrano in spazi che richiedono soluzioni distintive, accomunate da coerenza formale e minuziosi dettagli di eleganza grafica. Progettata da Andrea Steidl, Tuilli è un'ampia famiglia che trova posto negli ambienti comuni legati all'accoglienza e all'attesa e in quelli più privati degli spazi domestici. I vari componenti, con struttura in legno o metallo, mettono in luce una personalità forte ed eclettica che incontra gusti ed esigenze diverse, grazie a un'ampia gamma di finiture e rivestimenti.

Categorie: sedia, poltrona,  
sgabello, lounge, ottoman  
↳ p. 402  
Informazioni tecniche

Tuilli extends the concept of warm and refined hospitality to soft and enveloping shapes. Generous silhouettes are accompanied by volumes of different sizes that strike a recognisable aesthetic, an elegant balance between classic and modern. Numerous elements meet in spaces that require distinctive solutions, united by formal coherence and meticulous details of graphic elegance. Designed by Andrea Steidl, Tuilli is a wide collection that finds its place in the common areas related to welcoming and waiting, and in the more private ones of domestic spaces. The various components, with structure in wood or metal, highlight a strong and eclectic personality that meets different needs and tastes, thanks to a wide range of finishes and coatings.

Categorie: chair, armchair,  
stool, lounge chair, ottoman  
↳ p. 402  
Technical information







1.03.0/W Sedia con struttura in frassino, sedile e schienale rivestiti. — Chair with frame in ash, upholstered seat and back.  
2.03.0/W Poltrona con struttura in frassino, sedile e schienale rivestiti. — Armchair with frame in ash, upholstered seat and back.

2.03.0/X Poltrona con struttura in frassino, sedile e schienale rivestiti. — Armchair with frame in ash, upholstered seat and back.

8.01.Z Ottoman con struttura in metallo, sedile rivestito. — Ottoman with metal frame, upholstered seat.  
5.09.Z Lounge con struttura in metallo, sedile e schienale rivestiti. — Lounge chair with metal frame, upholstered seat and back.



2.03.0/X

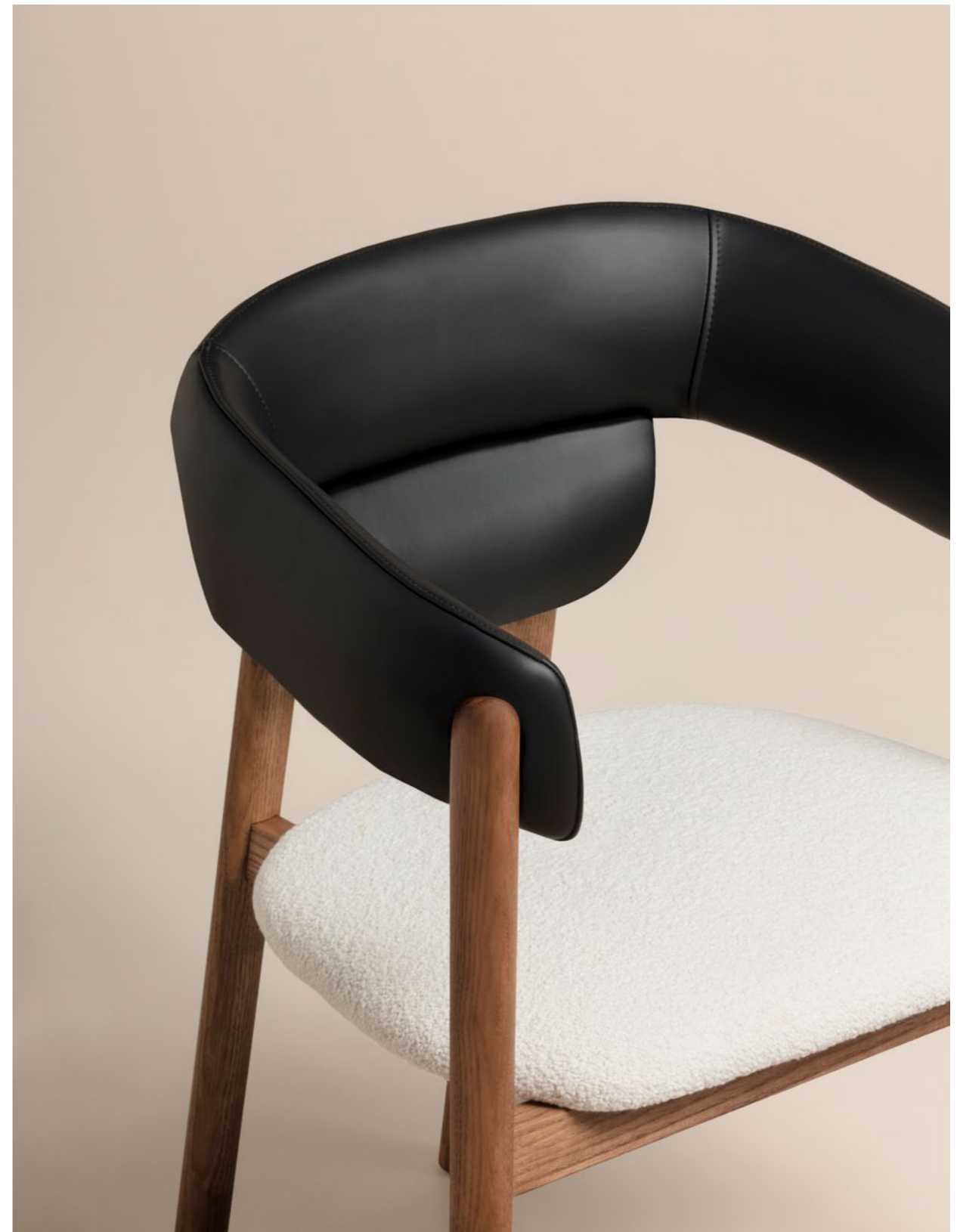

2.03.0/X





2.03.0-W



8.01.0  
5.09.0



5.09.Z  
8.01.Z

5.09.Z Lounge con struttura in metallo, sedile e schienale rivestiti.  
— Lounge chair with metal frame, upholstered seat and back.  
8.01.Z Ottoman con struttura in metallo, sedile rivestito. — Ottoman with metal frame, upholstered seat.

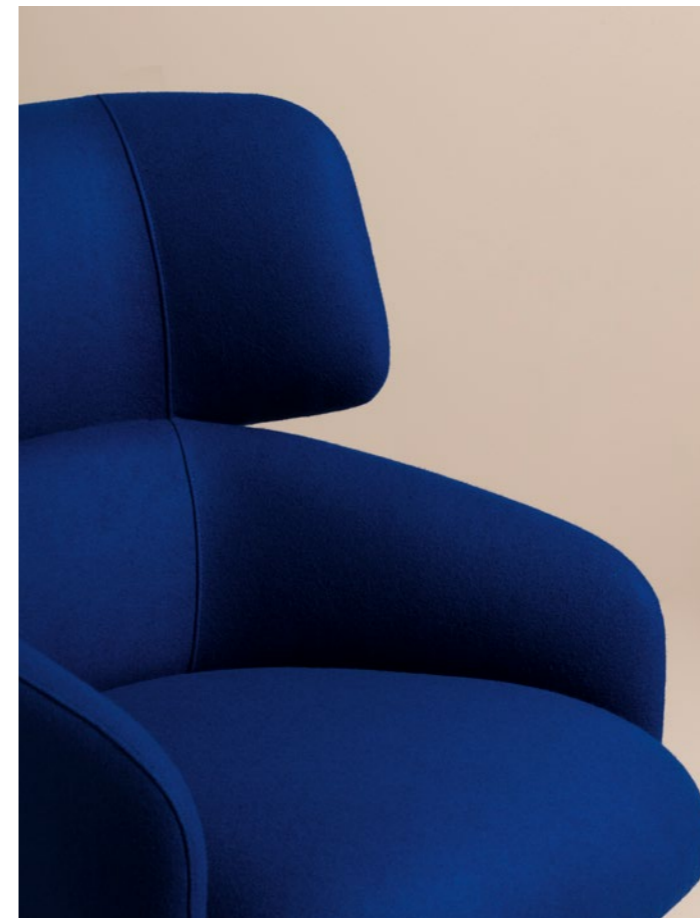

5.09.Z

5.09.Z Lounge con struttura in metallo, sedile e schienale rivestiti.  
— Lounge chair with metal frame, upholstered seat and back.



5.03.Z  
5.03.0

5.03.Z Lounge con struttura in metallo, sedile e schienale rivestiti.  
— Lounge chair with metal frame, upholstered seat and back.  
5.03.0 Lounge con struttura in frassino, sedile e schienale rivestiti.  
— Lounge chair with frame in ash, upholstered seat and back.





1.03.0/W

1.03.0/W



3.03.0/W



1.03.0/W Sedia con struttura in frassino, sedile e schienale rivestiti. — Chair with frame in ash, upholstered seat and back.

1.03.0/W Sedia con struttura in frassino, sedile e schienale rivestiti. — Chair with frame in ash, upholstered seat and back.  
3.03.0/W Sgabello con struttura in frassino, sedile e schienale rivestiti, poggiatesta in metallo. — Stool with frame in ash, upholstered seat and back, metal footrest.



3.03.0/X Sgabello con struttura in frassino, sedile e schienale rivestiti, poggipiedi in metallo. — Stool with frame in ash, upholstered seat and back, metal footrest.

1.03.0/X Sedia con struttura in frassino, sedile e schienale rivestiti. — Chair with frame in ash, upholstered seat and back.

3.03.0/W Sgabello con struttura in frassino, sedile e schienale rivestiti, poggipiedi in metallo. — Stool with frame in ash, upholstered seat and back, metal footrest.





1.03.0-X  
3.03.0-X

1.03.0/X Sedia con struttura in frassino, sedile e schienale rivestiti.  
— Chair with frame in ash, upholstered seat and back.  
3.03.0/X Sgabello con struttura in frassino, sedile e schienale rivestiti, poggiatesta in metallo. — Stool with frame in ash, upholstered seat and back, metal footrest.

3.03.0/X



1.03.0/X



1.03.0/X Sedia con struttura in frassino, sedile e schienale rivestiti.  
— Chair with frame in ash, upholstered seat and back.

3.03.0/X Sgabello con struttura in frassino, sedile e schienale rivestiti, poggiatesta in metallo. — Stool with frame in ash, upholstered seat and back, metal footrest.

## TIPI by Enzo Berti

Impilabilità. Un'identità specifica, che definisce una collezione. Enzo Berti ha individuato le potenzialità di questo concetto e l'ha tradotto in Tipi: un design leggero ed essenziale che trova nella particolare giunzione tra scocca e struttura un dettaglio discreto per unire e caratterizzare i vari elementi. Tipi propone soluzioni concrete per ambienti in continua evoluzione: open-space, sale conferenze, luoghi pubblici e tutti i contesti che devono potersi adattare a più situazioni e rispondere a esigenze diverse. L'estrema personalizzazione nelle finiture, di legno e metallo, e nei rivestimenti, oltre l'ampia gamma di elementi, che include anche tavolini e tavoli da bistrot, confermano una collezione che si lega a una promessa di comfort, carattere e flessibilità.

Categorie: sedia, sedia impilabile  
sgabello, sgabello impilabile,  
panca, panca impilabile, tavolo,  
tavolo impilabile  
↳ p. 397  
Informazioni tecniche

Stackability. A specific identity, which defines a collection. Enzo Berti identified the potential of this concept and translated it into Tipi: a light and essential design that finds a discreet detail in the particular junction between body and structure to unite and characterise the various elements. Tipi offers concrete solutions for constantly evolving environments: open-space, conference rooms, public places and all the multipurpose contexts where adaptability is a key requirement. The extreme customisation of finishes, in wood and metal, and in the coverings, not forgetting the vast range of elements, which includes coffee and bistro tables, confirms a collection that promises comfort, character and flexibility.

Categorie: chair, stackable chair,  
stool, stackable stool,  
bench, stackable bench, table,  
stackable table  
↳ p. 397  
Technical information



1.32.Z/1 Sedia impilabile con struttura in metallo, scocca in faggio, rivestimento frontale.  
— Stackable chair with metal frame, shell in beech, upholstered shell pad.



1.32.Z/1 Sedia impilabile con struttura in metallo, scocca in faggio, rivestimento frontale.  
— Stackable chair with metal frame, shell in beech, upholstered shell pad.





1.35.I Sedia impilabile con struttura e scocca in faggio, pannello sedile rivestito.  
— Stackable chair with frame and shell in beech, upholstered seat panel.  
1.38.Z/I Sedia impilabile con struttura in metallo, scocca in faggio, rivestimento frontale.  
— Stackable chair with metal frame, shell in beech, upholstered shell pad.

1.37.I Sedia impilabile con struttura e scocca in faggio, pannello sedile rivestito.  
— Stackable chair with frame and shell in beech, upholstered seat panel.  
1.32.Z/I Sedia impilabile con struttura in metallo, scocca in faggio, rivestimento frontale.  
— Stackable chair with metal frame, shell in beech, upholstered shell pad.

3.18.A Sgabello con struttura in faggio, pannello sedile rivestito. — Stool with frame in beech, upholstered seat panel.

3.32.0 Sgabello con struttura e scocca in faggio, rivestimento frontale. — Stool with frame and shell in beech, upholstered shell pad.



1.32.Z/1

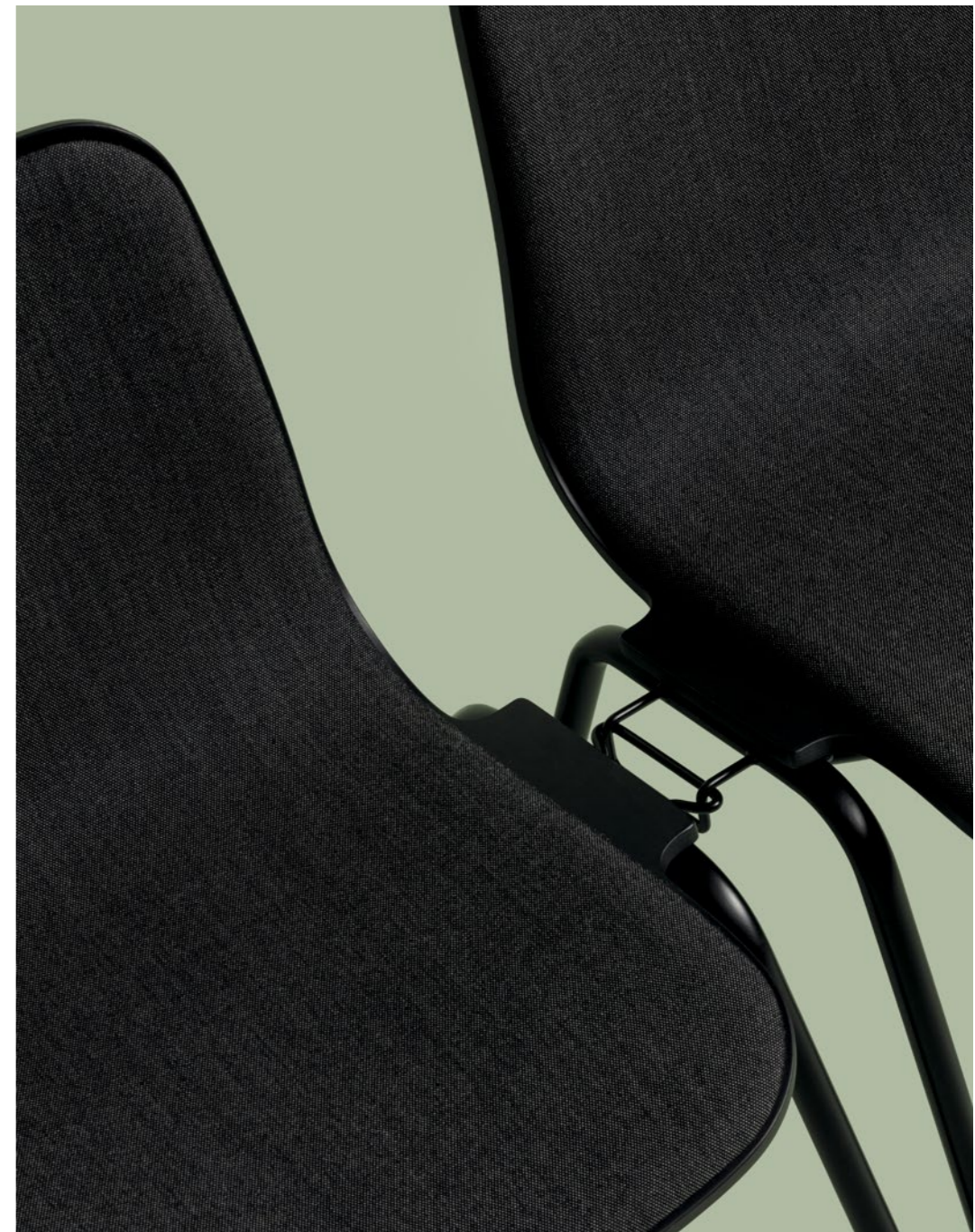

1.32.Z/1





1.35.I  
1.37.I

- 1.35.I Sedia impilabile con struttura e scocca in faggio, pannello sedile rivestito.  
— Stackable chair with frame and shell in beech, upholstered seat panel.
- 1.37.I Sedia impilabile con struttura e scocca in faggio, pannello sedile rivestito.  
— Stackable chair with frame and shell in beech, upholstered seat panel.



1.38.Z/I

- 1.38.Z/I Sedia con struttura in metallo, scocca in faggio, rivestimento frontale.  
— Chair with metal frame, shell in beech, upholstered shell pad.



3.32.0  
3.18.A

- 3.32.0 Sgabello con struttura e scocca in faggio, rivestimento frontale.  
— Stool with frame and shell in beech, upholstered shell pad.
- 3.18.A Sgabello con struttura in faggio, pannello sedile rivestito.  
— Stool with frame and shell in beech, upholstered seat panel.



3.37.Z

3.37.Z Sgabello con struttura in metallo, scocca in faggio, pannello sedile rivestito. — Stool with metal frame, shell in beech, upholstered seat panel.



3.32.Z  
3.37.Z

3.32.Z Sgabello con struttura in metallo, scocca in faggio, rivestimento frontale. — Stool with metal frame, shell in beech, upholstered shell pad.  
3.37.Z Sgabello con struttura in metallo, scocca in faggio, pannello sedile rivestito. — Stool with metal frame, shell in beech, upholstered seat panel.





9.40.H/Q  
3.32.0

9.40.H/Q Tavolo con struttura in faggio,  
top in laminato. — Table with  
frame in beech, laminate top.  
3.32.0 Sgabello con struttura e scocca  
in faggio, rivestimento frontale.  
— Stool with frame and shell  
in beech, upholstered shell pad.



9.40.A/I.Q  
9.40.A/I.T

9.40.A/I.Q Tavolo impilabile con struttura in faggio,  
top in laminato. — Stackable table  
with frame in beech, laminate top.  
9.40.A/I.T Tavolo impilabile con struttura in faggio,  
top in laminato. — Stackable table  
with frame in beech, laminate top.



3.19.B/I.Q  
9.40.A/I.T  
9.40.A/I.Q  
1.31.I

3.19.B/I.Q Sgabello impilabile con struttura in faggio, sedile in laminato. — Stackable stool with frame in beech, laminate seat panel.  
9.40.A/I.T Tavolo impilabile con struttura in faggio, top in laminato. — Stackable table with frame in beech, laminate top.

9.40.A/I.Q Tavolo impilabile con struttura in faggio, top in laminato. — Stackable table with frame in beech, laminate top.  
1.31.I Sedia impilabile con struttura e scocca in faggio. — Stackable chair with frame and shell in beech.

3.18.B/I  
3.17.B/I



7.23.3/I



3.18.B/I Sgabello impilabile con struttura in faggio, pannello sedile rivestito. — Stackable stool with frame in beech, upholstered seat panel.  
3.17.B/I Sgabello impilabile con struttura e sedile in faggio. — Stackable stool with frame and seat in beech.

7.23.3/I Panca impilabile con struttura in faggio, pannello sedile rivestito. — Stackable bench with frame in beech, upholstered seat panel.





## COCO

Sintesi di gusto moderno ed equilibrato, Coco è una collezione dalla personalità eclettica, capace di adattarsi con facilità a qualsiasi contesto. Il nitido profilo della struttura e le forme imbottite si sostengono in un perfetto equilibrio di linee e volumi. Coco riesce a entrare in qualsiasi spazio con uno stile inconfondibile. Grazie alla struttura in faggio o metallo e all'ampia gamma di finiture e rivestimenti disponibili, questa versatile collezione trova posto in spazi conviviali pubblici e privati offrendo comfort e funzionalità.

Categorie: sedia, poltrona,  
sgabello, lounge,  
panca, ottoman, divano  
p. 359  
Informazioni tecniche

A synthesis of modern and balanced taste, Coco is a collection with an eclectic personality, able to easily adapt to any context. The clear outline of the structure and the padded shapes are supported in a perfect balance between lines and volumes. Coco manages to enter any space with unique style. Thanks to the beech or metal structure and the wide range of finishes and coverings available, this versatile collection finds its place in public and private convivial spaces, offering comfort and functionality.

Categories: chair, armchair,  
stool, lounge chair,  
bench, ottoman, sofa  
p. 359  
Technical information



2.05.0  
1.05.0

- 2.05.0 Poltroncina con struttura in faggio, sedile rivestito, schienale in faggio rivestito frontalmente. — Armchair with frame in beech, upholstered seat, back in beech with upholstered pad.
- 1.05.0 Sedia con struttura in faggio, sedile rivestito, schienale in faggio rivestito frontalmente. — Chair with frame in beech, upholstered seat, back in beech with upholstered pad.



- 1.05.0 Sedia con struttura in faggio, sedile rivestito, schienale in faggio rivestito frontalmente. — Chair with frame in beech, upholstered seat, back in beech with upholstered pad.





3.10.0

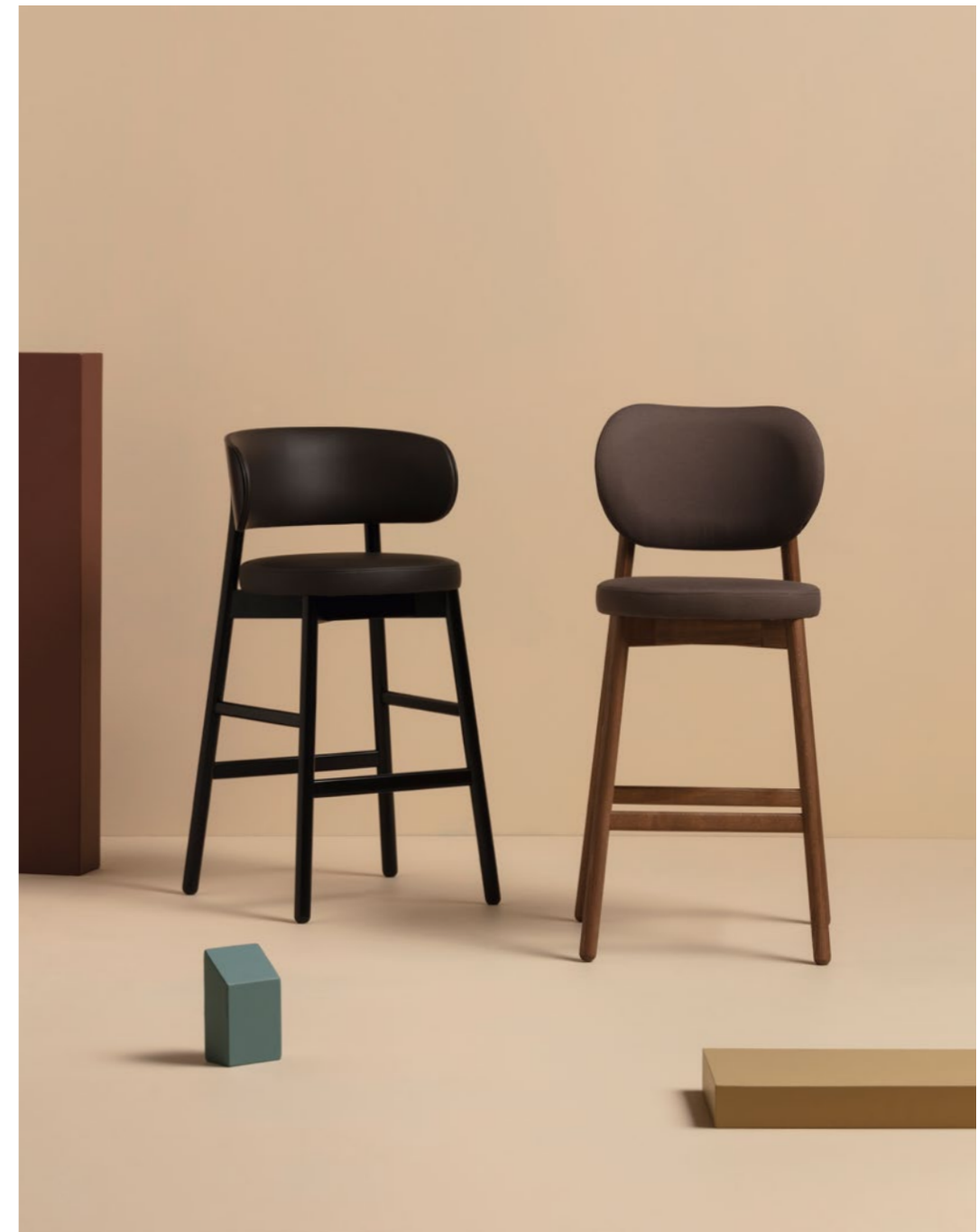

3.10.0  
3.03.0

3.10.0 Sgabello con struttura in faggio, sedile rivestito, schienale in faggio rivestito frontalmente. — Stool with frame in beech, upholstered seat, back in beech with upholstered pad.

3.10.0 Sgabello con struttura in faggio, sedile rivestito, schienale in faggio rivestito frontalmente. — Stool with frame in beech, upholstered seat, back in beech with upholstered pad.  
3.03.0 Sgabello con struttura in faggio, sedile e schienale rivestiti. — Stool with frame in beech, upholstered seat and back.



2.03.0 Poltroncina con struttura in faggio, sedile e schienale rivestiti. — Armchair with frame in beech, upholstered seat and back.  
 2.03.Z Poltroncina con struttura in metallo, sedile e schienale rivestiti. — Armchair with metal frame, upholstered seat and back.

1.03.0 Sedia con struttura in faggio, sedile e schienale rivestiti. — Chair with frame in beech, upholstered seat and back.

3.10.Z Sgabello con struttura in metallo, sedile rivestito, schienale in faggio rivestito frontalmente. — Stool with metal frame, upholstered seat, back in beech with upholstered pad.  
 3.03.Z Sgabello con struttura in metallo, sedile e schienale rivestiti. — Stool with metal frame, upholstered seat and back.

1.03.Z Sedia con struttura in metallo, sedile e schienale rivestiti. — Chair with metal frame, upholstered seat and back.





2.03.Z  
1.03.Z

- 2.03.Z Poltroncina con struttura in metallo, sedile e schienale rivestiti. — Armchair with metal frame, upholstered seat and back.
- 1.03.Z Sedia con struttura in metallo, sedile e schienale rivestiti. — Chair with metal frame, upholstered seat and back.



5.03.Z  
8.01.Z

- 5.03.Z Lounge con struttura in metallo, sedile e schienale rivestiti. — Lounge chair with metal frame, upholstered seat and back.
- 8.01.Z Ottoman con struttura in metallo, sedile rivestito. — Ottoman with metal frame, upholstered seat.



3.03.Z  
3.10.Z

- 3.03.Z Sgabello con struttura in metallo, sedile e schienale rivestiti. — Stool with metal frame, upholstered seat and back.
- 3.10.Z Sgabello con struttura in metallo, sedile rivestito, schienale in faggio rivestito frontalmente. — Stool with metal frame, upholstered seat, back in beech with upholstered pad.



5.03.0  
8.01.0



7.01.0



6.03.0

5.03.0 Lounge con struttura in faggio,  
sedile e schienale rivestiti.  
— Lounge chair with frame in beech,  
upholstered seat and back.  
8.01.0 Ottoman con struttura in faggio,  
sedile rivestito. — Ottoman with frame  
in beech, upholstered seat.  
7.01.0 Panca con struttura in faggio,  
sedile rivestito. — Bench with frame  
in beech, upholstered seat.

6.03.0 Divano con struttura in faggio,  
sedile e schienale rivestiti.  
— Sofa with frame in beech,  
upholstered seat and back.



## PALMO by LucidiPevere

Accogliente e invitante, Palmo unisce due anime in una promessa di comfort e funzionalità: linee decise e morbide si ritrovano in proporzioni armoniose che legano un design moderno ed accattivante a un senso di comodità e dinamismo. Disegnata da LucidiPevere, Palmo è una collezione che valorizza spazi comuni professionali e commerciali, e ambienti domestici di stili diversi. Sedia, poltrona e sgabello si vestono di materiali selezionati per creare abbinamenti dalle molteplici soluzioni, tra rassicuranti monocromie e contrasti più contemporanei. Sgabello e panca completano questa vasta famiglia dal carattere razionale e carismatico.

Categorie: sedia, sedia girevole, poltrona, poltrona girevole, sgabello, sgabello girevole e regolabile, panca  
↳ p. 379  
Informazioni tecniche

Welcoming and inviting, Palmo unites two souls in a promise of comfort and functionality: soft and defined lines are found in harmonious proportions that link a modern and captivating design to a sense of comfort and dynamism. Designed by LucidiPevere, Palmo is a collection that enhances professional and commercial common spaces, and domestic environments of diverse styles. Chair, armchair and stool are finished in selected materials to create combinations with multiple solutions, including reassuring monochromes and more contemporary contrasts. Stool and bench complete this vast family with a rational and charismatic character.

Categorie: chair, swivel chair, armchair, swivel armchair, stool, swivel and adjustable stool, bench  
↳ p. 379  
Technical information



2.05.Z Poltrona con struttura in metallo, sedile in faggio con pannello rivestito, schienale in faggio rivestito frontalmente. – Armchair with metal frame, seat in beech with upholstered panel, back in beech with upholstered pad.



2.05.Z Poltrona con struttura in metallo, sedile in faggio con pannello rivestito, schienale in faggio rivestito frontalmente. – Armchair with metal frame, seat in beech with upholstered panel, back in beech with upholstered pad.



1.05.Z



1.05.Z

1.05.Z Sedia con struttura in metallo, sedile in faggio con pannello rivestito, schienale in faggio rivestito frontalmente. — Chair with metal frame, seat in beech with upholstered panel, back in beech with upholstered pad.



2.05.Z

2.05.Z Poltrona con struttura in metallo, sedile in faggio con pannello rivestito, schienale in faggio rivestito frontalmente. — Armchair with metal frame, seat in beech with upholstered panel, back in beech with upholstered pad.





1.03.0  
2.03.0

- 1.03.0 Sedia con struttura in faggio, sedile in faggio con pannello rivestito, schienale rivestito.  
— Chair with frame in beech, seat in beech with upholstered panel, upholstered back.
- 2.03.0 Poltrona con struttura in faggio, sedile in faggio con pannello rivestito, schienale rivestito.  
— Armchair with frame in beech, seat in beech with upholstered panel, upholstered back.



2.03.0



3.03.0  
3.09.0

- 3.03.0 Sgabello con struttura in faggio, sedile in faggio con pannello rivestito, schienale rivestito. — Stool with frame in beech, seat in beech with upholstered panel, upholstered back.
- 3.09.0 Sgabello con struttura in faggio, sedile in faggio con pannello rivestito, schienale rivestito. — Stool with frame in beech, seat in beech with upholstered panel, upholstered back.



2.05.0 Poltrona con struttura in faggio, sedile in faggio con pannello rivestito, schienale in faggio rivestito frontalmente.  
— Armchair with frame in beech, seat in beech with upholstered panel, back in beech with upholstered pad.  
3.10.0 Sgabello con struttura in faggio, sedile in faggio con pannello rivestito, schienale in faggio rivestito frontalmente.  
— Stool with frame in beech, seat in beech with upholstered panel, back in beech with upholstered pad.

3.05.0 Sgabello con struttura in faggio, sedile in faggio con pannello rivestito, schienale in faggio rivestito frontalmente.  
— Stool with frame in beech, seat in beech with upholstered panel, back in beech with upholstered pad.  
7.01.0 Panca con struttura in faggio, sedile in faggio con pannello rivestito.  
— Bench with frame in beech, seat in beech with upholstered panel.

1.05.0 Sedia con struttura in faggio, sedile in faggio con pannello rivestito, schienale in faggio rivestito frontalmente.  
— Chair with frame in beech, seat in beech with upholstered panel, back in beech with upholstered pad.

3.16.A Sgabello con struttura in faggio, sedile in faggio con pannello rivestito.  
— Stool with frame in beech, seat in beech with upholstered panel.  
3.16.B Sgabello con struttura in faggio, sedile in faggio con pannello rivestito.  
— Stool with frame in beech, seat in beech with upholstered panel.





1.05.0  
3.05.0



7.01.0

1.05.0 Sedia con struttura in faggio, sedile in faggio con pannello rivestito, schienale in faggio rivestito frontalmente. — Chair with frame in beech, seat in beech with upholstered panel, back in beech with upholstered pad.

3.05.0 Sgabello con base in faggio, sedile in faggio con pannello rivestito, schienale in faggio rivestito frontalmente. — Stool with frame in beech, seat in beech with upholstered panel, back in beech with upholstered pad.  
7.01.0 Panca con base in faggio, sedile in faggio con pannello rivestito. — Bench with frame in beech, seat in beech with upholstered panel.



1.05.0

1.05.0 Sedia con struttura in faggio, sedile in faggio con pannello rivestito, schienale in faggio rivestito frontalmente. — Chair with frame in beech, seat in beech with upholstered panel, back in beech with upholstered pad.



B.05.0 Poltrona girevole con struttura in metallo, sedile in faggio con pannello rivestito, schienale in faggio rivestito frontalmente.  
 — Swivel armchair with metal frame, seat in beech with upholstered panel, back in beech with upholstered pad.  
 A.03.0 Sedia girevole con struttura in metallo, sedile in faggio con pannello rivestito, schienale rivestito. — Swivel chair with metal frame, seat in beech with upholstered panel, upholstered back.

B.03.0 Poltrona girevole con struttura in metallo, sedile in faggio con pannello rivestito, schienale rivestito. — Swivel armchair with metal frame, seat in beech with upholstered panel, upholstered back.

C.05.0/R Sgabello girevole e regolabile con struttura in metallo, sedile in faggio con pannello rivestito, schienale in faggio rivestito frontalmente.  
 — Swivel and adjustable stool with metal frame, seat in beech with upholstered panel, back in beech with upholstered pad.

3.16.Z Sgabello con struttura in metallo, sedile in faggio con pannello rivestito.  
 — Stool with metal frame, seat in beech with upholstered panel.  
 A.03.0/W Sedia girevole con struttura in faggio, sedile in faggio con pannello rivestito, schienale rivestito. — Swivel chair with frame in beech, seat in beech with upholstered panel, upholstered back.





A.05.0

A.05.0 Sedia girevole con struttura in metallo, sedile in faggio con pannello rivestito, schienale in faggio rivestito frontalmente.  
 — Swivel chair with metal frame, seat in beech with upholstered panel, back in beech with upholstered pad.



A.05.0  
 A.03.0/W  
 A.03.0

A.05.0 Sedia girevole con struttura in metallo, sedile in faggio con pannello rivestito, schienale in faggio rivestito frontalmente.  
 — Swivel chair with metal frame, seat in beech with upholstered panel, back in beech with upholstered pad.

A.03.0/W Sedia girevole con struttura in faggio, sedile in faggio con pannello rivestito, schienale rivestito.  
 — Swivel chair with frame in beech, seat in beech with upholstered panel, upholstered back.  
 A.03.0 Sedia girevole con struttura in metallo, sedile in faggio con pannello rivestito, schienale rivestito.  
 — Swivel chair with metal frame, seat in beech with upholstered panel, upholstered back.



B.05.0  
B.03.0

**LUCIDIPEVERE**  
Paolo Lucidi e Luca Pevero lavorano insieme dal 2003. Nel 2006 hanno fondato LucidiPevero, uno studio di design con base a Palmanova (Udine), riconosciuto a livello internazionale.

Paolo Lucidi and Luca Pevero have worked together since 2003. In 2006 they founded LucidiPevero, an internationally known design firm based in Palmanova (Udine).



- B.05.0** Poltrona girevole con struttura in metallo, sedile in faggio con pannello rivestito, schienale in faggio rivestito frontalmente.  
— Swivel armchair with metal frame, seat in beech with upholstered panel, back in beech with upholstered pad.
- B.03.0** Poltrona girevole con struttura in metallo, sedile in faggio con pannello rivestito, schienale rivestito. — Swivel armchair with metal frame, seat in beech with upholstered panel, upholstered back.



B.05.0/W



- B.05.0/W** Poltrona girevole con struttura in faggio, sedile in faggio con pannello rivestito, schienale in faggio rivestito frontalmente.  
— Swivel armchair with frame in beech, seat in beech with upholstered panel, back in beech with upholstered pad.





C.03.0/R  
C.05.0/R



3.16.Z



C.10.0/R  
C.09.0/R

C.03.0/R Sgabello girevole e regolabile con struttura in metallo, sedile in faggio con pannello rivestito, schienale rivestito. — Swivel and adjustable stool with metal frame, seat in beech with upholstered panel, upholstered back.  
C.05.0/R Sgabello girevole e regolabile con struttura in metallo, sedile in faggio con pannello rivestito, schienale in faggio rivestito frontalmente. — Swivel and adjustable stool with metal frame, seat in beech with upholstered panel, back in beech with upholstered pad.

3.16.Z Sgabello con struttura in metallo, sedile in faggio con pannello rivestito. — Stool with metal frame, seat in beech with upholstered panel.

C.10.0/R Sgabello girevole e regolabile con struttura in metallo, sedile in faggio con pannello rivestito, schienale in faggio rivestito frontalmente. — Swivel and adjustable stool with metal frame, seat in beech with upholstered panel, back in beech with upholstered pad.  
C.09.0/R Sgabello girevole e regolabile con struttura in metallo, sedile in faggio con pannello rivestito, schienale rivestito. — Swivel and adjustable stool with metal frame, seat in beech with upholstered panel, upholstered back.

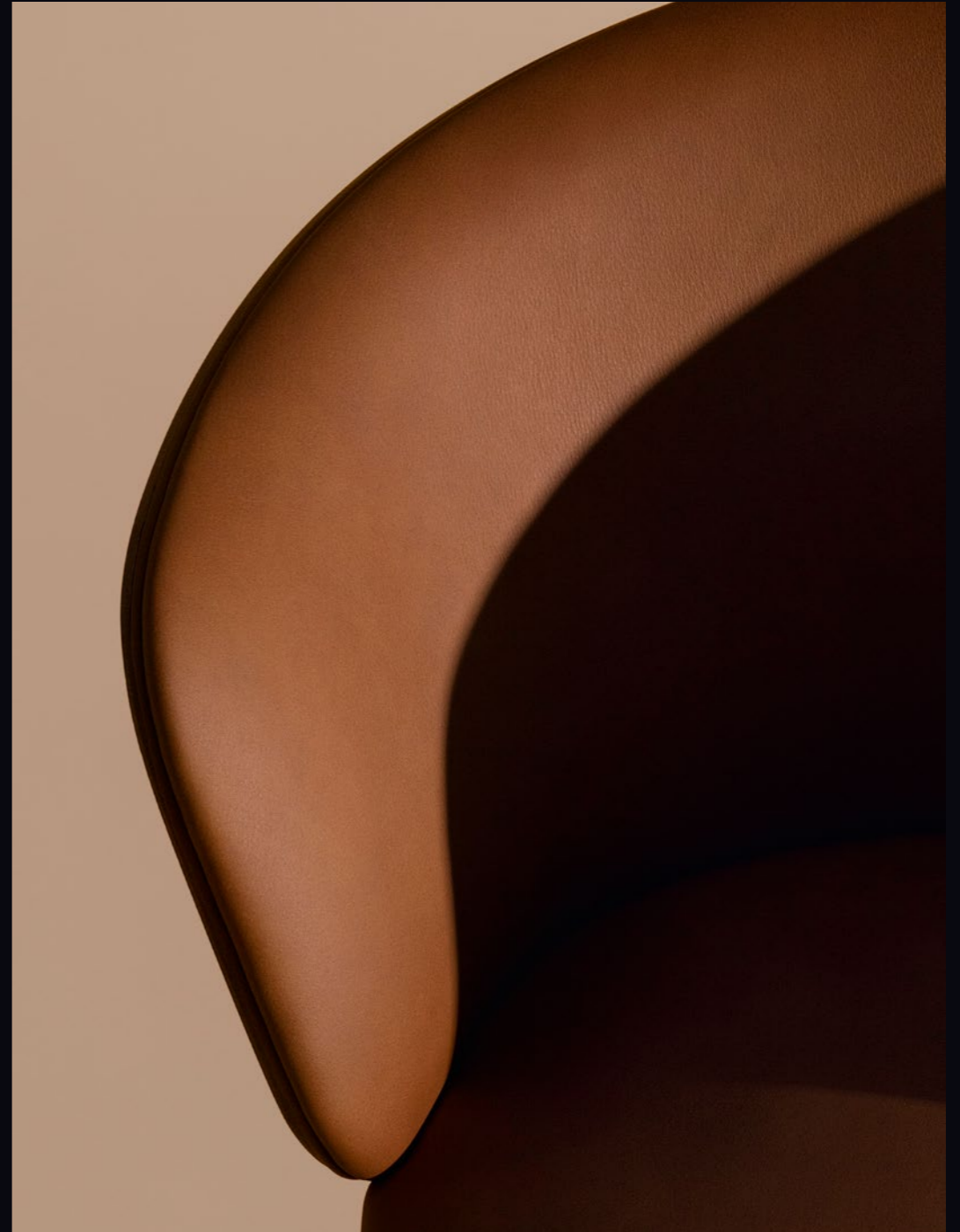



## HYPPO by Valerio Sommella

Sottili elementi lignei affiorano tra volumi pieni e generosi, creando un dettaglio che cattura l'attenzione e unisce i vari componenti della collezione disegnata da Valerio Sommella. Hyppo riesce a valorizzare il legno con una presenza discreta, che passa quasi in secondo piano rispetto a sagome imponenti e delicatamente delineate dalla totale assenza di spigoli. Hyppo si adatta a diverse interpretazioni che trovano posto in contesti e situazioni legate alla pausa e al relax. Formata da numerosi elementi, questa vasta famiglia di imbottiti può essere rivestita in pelle o tessuto per creare molteplici combinazioni in grado di trasmettere una sensazione di calda accoglienza e comfort assoluto.

Categorie: lounge, pouf,  
divano, panca, tavolo  
→ p. 370  
Informazioni tecniche

Subtle wooden elements emerge between full and generous volumes, creating a detail that captures the attention, and unites the various components of the collection designed by Valerio Sommella. Hyppo enhances the wood with a discreet presence, superimposed on silhouettes delicately outlined by the total absence of edges. Hyppo's adaptability lends itself to different interpretations that settle easily within contexts and situations related to pause and relaxation. Made up of numerous elements, this vast family of upholstered items can be finished in leather or fabric, to create multiple combinations and evoke a feeling of warm welcome and absolute comfort.

Categorie: lounge chair,  
pouf, sofa, bench, table  
→ p. 370  
Technical information



6.03.L  
7.01.L

- 6.03.L Divano con gambe in faggio e struttura in legno, sedile e schienale rivestiti. — Sofa with legs in beech and wooden frame, upholstered seat and back.
- 7.01.L Panca con gambe in faggio e struttura in legno, sedile rivestito. — Bench with legs in beech and wooden frame, upholstered seat.



- 5.09.L Lounge con gambe in faggio e struttura in legno, sedile e schienale rivestiti. — Lounge chair with legs in beech and wooden frame, upholstered seat and back.



5.09.L



5.03.L  
9.40.J

- 5.09.L Lounge con gambe in faggio e struttura in legno, sedile e schienale rivestiti.  
— Lounge chair with legs in beech and wooden frame, upholstered seat and back.
- 5.03.L Lounge con gambe in faggio e struttura in legno, sedile e schienale rivestiti.  
— Lounge chair with legs in beech and wooden frame, upholstered seat and back.
- 9.40.J Tavolino con struttura in faggio e base in legno, top in laminato. — Coffee table with frame in beech and wooden base, laminate top.



5.09.L  
C.HY.0

- 5.09.L Lounge con gambe in faggio e struttura in legno, sedile e schienale rivestiti.  
— Lounge chair with legs in beech and wooden frame, upholstered seat and back.
- C.HY.0 Cuscino — Cushion





5.03.L Lounge con gambe in faggio e struttura in legno, sedile e schienale rivestiti.  
— Lounge chair with legs in beech and wooden frame, upholstered seat and back.  
C.HY.0 Cuscino — Cushion

7.01.L Panca con gambe in faggio e struttura in legno, sedile rivestito. — Bench with legs in beech and wooden frame, upholstered seat.  
4.01.ML Pouf con gambe in faggio e struttura in legno, sedile rivestito. — Pouf with legs in beech and wooden frame, upholstered seat.

6.03.L Divano con gambe in faggio e struttura in legno, sedile e schienale rivestiti.  
— Sofa with legs in beech and wooden frame, upholstered seat and back.  
C.HY.0 Cuscino — Cushion

4.01.ML Pouf con gambe in faggio e struttura in legno, sedile rivestito. — Pouf with legs in beech and wooden frame, upholstered seat.  
4.01.PL Pouf con gambe in faggio e struttura in legno, sedile rivestito. — Pouf with legs in beech and wooden frame, upholstered seat.  
5.03.L Lounge con gambe in faggio e struttura in legno, sedile e schienale rivestiti. — Lounge chair with legs in beech and wooden frame, upholstered seat and back.



6.03.L  
7.01.L



4.01.PL  
4.01.GL  
4.01.ML

6.03.L Divano con gambe in faggio e struttura in legno, sedile e schienale rivestiti. — Sofa with legs in beech and wooden frame, upholstered seat and back.  
7.01.L Panca con gambe in faggio e struttura in legno, sedile rivestito. — Bench with legs in beech and wooden frame, upholstered seat.

4.01.PL Pouf con gambe in faggio e struttura in legno, sedile rivestito. — Pouf with legs in beech and wooden frame, upholstered seat.  
4.01.GL Pouf con gambe in faggio e struttura in legno, sedile rivestito. — Pouf with legs in beech and wooden frame, upholstered seat.  
4.01.ML Pouf con gambe in faggio e struttura in legno, sedile rivestito. — Pouf with legs in beech and wooden frame, upholstered seat.



6.03.L  
C.HY.0  
4.01.ML

6.03.L Divano con gambe in faggio e struttura in legno, sedile e schienale rivestiti. — Sofa with legs in beech and wooden frame, upholstered seat and back.  
C.HY.0 Cuscino — Cushion

4.01.ML Pouf con gambe in faggio e struttura in legno, sedile rivestito. — Pouf with legs in beech and wooden frame, upholstered seat.





6.09.L  
C.HY.0



**VALERIO SOMMELLA**  
Nasce a Cortona nel 1980, cresce professionalmente a Milano dove studia e si laurea in industrial design al Politecnico. Considera ogni progetto come un'opportunità per definire la sua idea di design, ovvero un delicato equilibrio tra contesto, pubblico, materiali, tecnologie, forma e funzione.

Born in Cortona in 1980, he grew up professionally in Milan where he studied and graduated in industrial design at the Politecnico. He considers each project as an opportunity to define his idea of design, or a delicate balance between context, public, materials, technologies, form and function.



6.09.L Divano con gambe in faggio e struttura in legno, sedile e schienale rivestiti.  
— Sofa with legs in beech and wooden frame, upholstered seat and back.  
C.HY.0 Cuscino — Cushion



4.01.TL

4.01.TL Pouf con gambe in faggio e struttura in legno, sedile rivestito. — Pouf with legs in beech and wooden frame, upholstered seat.



4.01.RL

4.01.RL Pouf con gambe in faggio e struttura in legno, sedile rivestito. — Pouf with legs in beech and wooden frame, upholstered seat.



4.01.RL  
9.40.0

4.01.RL Pouf con gambe in faggio e struttura in legno, sedile rivestito. — Pouf with legs in beech and wooden frame, upholstered seat.  
9.40.0 Tavolino con struttura in faggio e top in laminato. — Coffee table with frame in beech, laminate top





4.01.RL



4.01.RL  
9.40.J

4.01.RL Pouf con gambe in faggio e struttura in legno, sedile rivestito. — Pouf with legs in beech and wooden frame, upholstered seat.

4.01.RL Pouf con gambe in faggio e struttura in legno, sedile rivestito. — Pouf with legs in beech and wooden frame, upholstered seat.  
9.40.J Tavolino con struttura in faggio e base in legno, top in laminato. — Coffee table with frame in beech and wooden base, laminate top.



## FLY

Linee agili ed essenziali tracciano i profili di Fly, collezione dal design in grado di valorizzare gli interni di ristoranti e caffetterie, sale da pranzo e cucine domestiche. La forma delle sedute evoca una sensazione di dinamica leggerezza che unisce gli elementi della famiglia. Fly fonde comfort ed estetica in una sintesi perfetta. Morbide giunzioni e materiali di diverse consistenze e colori mettono in luce la ricercata attenzione rivolta a ogni singolo dettaglio.

Categorie: sedia,  
sedia impilabile, sgabello  
↳ p. 364  
Informazioni tecniche

Agile and essential lines trace the profiles of Fly, a collection with a design capable of enhancing the interiors of restaurants and cafes, dining rooms and domestic kitchens. The shape of the seats evokes feelings of dynamic lightness that links the elements of the family. Fly blends comfort and aesthetics in a perfect synthesis. Soft joints and materials of varied textures and colours highlight the refined attention paid to every single detail.

Categorie: chair,  
stackable chair, stool  
↳ p. 364  
Technical information



1.01.I Sedia impilabile con struttura in faggio, sedile rivestito.  
— Stackable chair with frame in beech, upholstered seat.



1.03.I Sedia impilabile con struttura in faggio, sedile rivestito, schienale in faggio con pannello rivestito.  
— Stackable chair with frame in beech, upholstered seat, back in beech with upholstered panel.





1.01.1 Sedia impilabile con struttura in faggio, sedile rivestito.  
— Stackable chair with frame in beech, upholstered seat.

1.02.1 Sedia impilabile con struttura, sedile e schienale in faggio.  
— Stackable chair with frame, seat and back in beech.

1.01.1 Sedia impilabile con struttura in faggio, sedile rivestito.  
— Stackable chair with frame in beech, upholstered seat.

3.01.0 Sgabello con struttura in faggio, sedile rivestito. — Stool with frame in beech, upholstered seat.  
3.02.0 Sgabello con struttura, sedile e schienale in faggio. — Stool with frame, seat and back in beech.



1.03.1



1.03.1



1.03.1  
1.02.1

1.03.1 Sedia impilabile con struttura in faggio, sedile rivestito, schienale in faggio con pannello rivestito. — Stackable chair with frame in beech, upholstered seat, back in beech with upholstered panel.

1.03.1 Sedia impilabile con struttura in faggio, sedile rivestito, schienale in faggio con pannello rivestito. — Stackable chair with frame in beech, upholstered seat, back in beech with upholstered panel.  
1.02.1 Sedia impilabile con struttura, sedile e schienale in faggio. — Stackable chair with frame, seat and back in beech.





1.02.1



1.02.1



1.02.1  
3.02.0

1.02.1 Sedia impilabile con struttura,  
sedile e schienale in faggio.  
— Stackable chair with frame,  
seat and back in beech.

1.02.1 Sedia impilabile con struttura,  
sedile e schienale in faggio.  
— Stackable chair with frame,  
seat and back in beech.  
3.02.0 Sgabello con struttura, sedile  
e schienale in faggio. — Stool with  
frame, seat and back in beech.



3.01.0  
3.03.0

3.01.0 Sgabello con struttura in faggio, sedile rivestito. — Stool with frame in beech, upholstered seat.  
3.03.0 Sgabello con struttura in faggio, sedile rivestito, schienale in faggio con pannello rivestito. — Stool with frame in beech, upholstered seat, back in beech with upholstered panel.

3.01.0

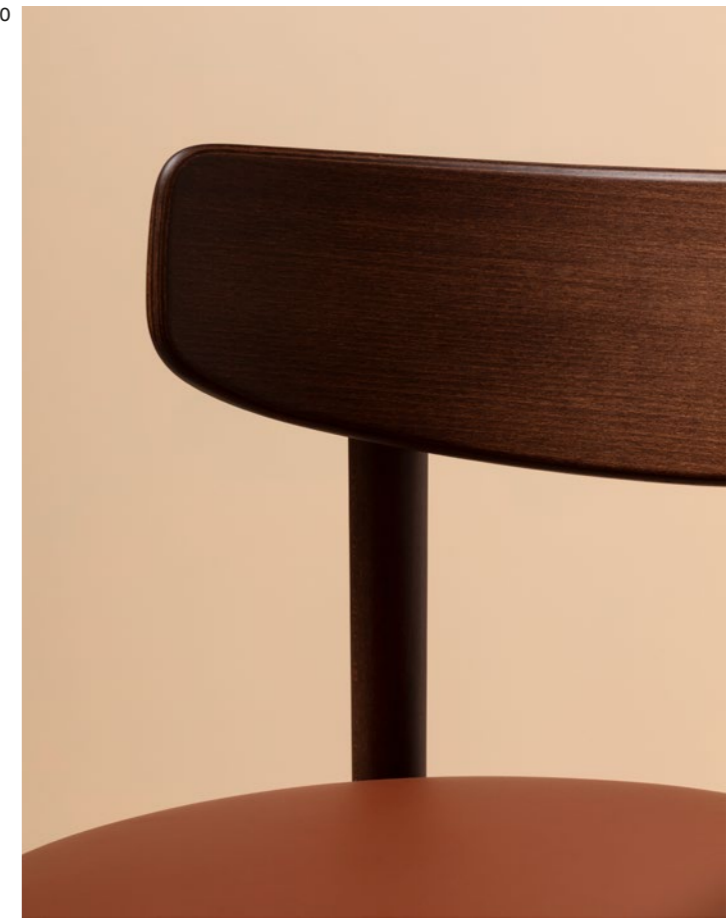

3.03.0

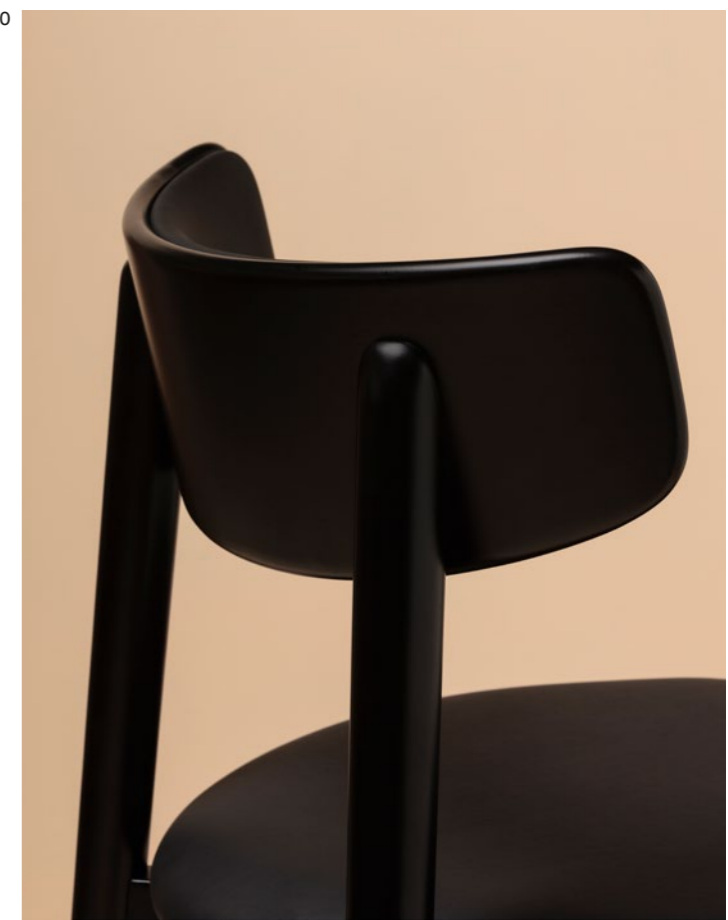

3.01.0 Sgabello con struttura in faggio, sedile rivestito. — Stool with frame in beech, upholstered seat.  
3.03.0 Sgabello con struttura in faggio, sedile rivestito, schienale in faggio con pannello rivestito. — Stool with frame in beech, upholstered seat, back in beech with upholstered panel.



## OBI by LucidiPevere

Tra nette geometrie e linee morbide e sinuose, la collezione di LucidiPevere svela proporzioni equilibrate e dettagli accurati. La cintura in legno che abbraccia l'intera seduta delinea un carattere forte e distintivo, esaltato da finiture che disegnano con precisione il profilo dell'avvolgente schienale. Con Obi la classica sedia da bistrot diventa un elemento in grado di conferire uno stile peculiare agli spazi in cui viene inserita. Obi è disponibile in diverse versioni. Sedia e poltrona sottolineano le eleganti forme dello schienale e della seduta con il rivestimento in pelle o tessuto di svariati colori. Panca e sgabelli offrono ulteriori soluzioni d'arredo che permettono a questa famiglia di inserirsi con eleganza e personalità anche in ambienti contract.

Categorie: sedia, poltrona,  
sgabello, panca  
p. 378  
Informazioni tecniche

Clear geometries and soft sinuous lines combine in the collection by LucidiPevere, revealing balanced proportions and precise details. The wooden belt that embraces the entire seat outlines a strong and distinctive character, enhanced by finishes that accurately draw the profile of the enveloping backrest. With Obi the classic bistro chair becomes an element capable of giving a unique style to the spaces in which it resides. Obi is available in different versions. Chair and armchair emphasize the elegant shapes of the backrest and seat with the upholstery in leather or fabric of various colours. Bench and stools offer further furnishing solutions that allow this family to fit with elegance and personality even into contract environments.

Categorie: chair, armchair,  
stool, bench  
p. 378  
Technical information



1.03.0 Sedia con struttura in faggio,  
sedile e schienale rivestiti.  
— Chair with frame in beech,  
upholstered seat and back.



1.03.0 Sedia con struttura in faggio,  
sedile e schienale rivestiti.  
— Chair with frame in beech,  
upholstered seat and back.



2.03.0



2.03.0

2.03.0 Poltroncina con struttura in faggio, sedile e schienale rivestiti.  
— Armchair with frame in beech, upholstered seat and back.

2.03.0 Poltroncina con struttura in faggio, sedile e schienale rivestiti.  
— Armchair with frame in beech, upholstered seat and back.





3.03.0  
1.03.0  
3.16.A



3.03.0

3.03.0 Sgabello con struttura in faggio, sedile e schienale rivestiti. — Stool with frame in beech, upholstered seat and back.

1.03.0 Sedia con struttura in faggio, sedile e schienale rivestiti. — Chair with frame in beech, upholstered seat and back.  
3.16.A Sgabello con struttura in faggio, sedile rivestito. — Stool with frame in beech, upholstered seat.



3.16.B  
1.03.0

3.16.B Sgabello con struttura in faggio, sedile rivestito. — Stool with frame in beech, upholstered seat.  
1.03.0 Sedia con struttura in faggio, sedile e schienale rivestiti. — Chair with frame in beech, upholstered seat and back.



1.03.0 Sedia con struttura in faggio, sedile e schienale rivestiti. — Chair with frame in beech, upholstered seat and back.  
3.16.B Sgabello con struttura in faggio, sedile rivestito. — Stool with frame in beech, upholstered seat.

3.16.A Sgabello con struttura in faggio, sedile rivestito. — Stool with frame in beech, upholstered seat.

3.03.0 Sgabello con struttura in faggio, sedile e schienale rivestiti. — Stool with frame in beech, upholstered seat and back.

7.01.0 Panca con struttura in faggio, sedile rivestito. — Bench with frame in beech, upholstered seat.





3.16.A



3.16.A  
1.03.0  
3.03.0

3.16.A Sgabello con struttura in faggio,  
sedile rivestito. — Stool with frame  
in beech, upholstered seat.

3.16.A Sgabello con struttura in faggio,  
sedile rivestito. — Stool with frame  
in beech, upholstered seat.  
1.03.0 Sedia con struttura in faggio, sedile  
e schienale rivestiti. — Chair with frame  
in beech, upholstered seat and back.

3.03.0 Sgabello con struttura in faggio,  
sedile e schienale rivestiti.  
— Stool with frame in beech,  
upholstered seat and back.



1.03.0  
3.16.A  
7.01.0

1.03.0 Sedia con struttura in faggio, sedile e schienale rivestiti. — Chair with frame in beech, upholstered seat and back.  
3.16.A Sgabello con struttura in faggio, sedile rivestito. — Stool with frame in beech, upholstered seat.

7.01.0 Panca con struttura in faggio, sedile rivestito. — Bench with frame in beech, upholstered seat.



3.16.B  
3.03.0

3.16.B Sgabello con struttura in faggio, sedile rivestito. — Stool with frame in beech, upholstered seat.  
3.03.0 Sgabello con struttura in faggio, sedile e schienale rivestiti. — Stool with frame in beech, upholstered seat and back.



## CORI by Andrea Steidl

Linee sinuose e naturali seguono il profilo di Cori, la collezione di Andrea Steidl che invita a prendersi una pausa tra forme comode e rasserenanti. La scocca lascia cogliere la sua essenza nella versione senza rivestimento: una sagoma morbida, dalla curvatura magistrale, e un sottile gioco di pieni e vuoti mostrano come solo una sapiente lavorazione possa incontrare i progetti creativi più audaci. Cori è adattabile a svariati contesti. Dalle hall degli hotel alle sale d'attesa, dalle zone lounge agli ambienti domestici, questa trasversale collezione fa incontrare comfort e ricerca estetica con una visione contemporanea. Può essere tappezzata in una vasta gamma di colori e materiali o, su richiesta, realizzata nella preziosa versione in legno.

Categorie: poltrona,  
poltrona girevole,  
lounge, lounge girevole  
↳ p. 363  
Informazioni tecniche

Gentle curves and natural lines follow the profile of Cori, the Andrea Steidl collection that invites you to relax between comfortable and soothing shapes. The shells essence is captured in the version without upholstery: a soft shape, with masterful curvature, and a subtle play of solids and voids demonstrate how only skillful workmanship can meet the most daring creative projects. Cori is adaptable to various contexts. From hotel lobbies to waiting rooms, from lounge areas to domestic environments, this transversal collection is the culmination of comfort, aesthetic research and contemporary vision. It can be upholstered in a wide range of colours and materials or, upon request, realised in the precious wooden version.

Categorie: armchair,  
swivel armchair, lounge chair,  
swivel lounge chair  
↳ p. 363  
Technical information



5.39.0  
2.39.0

- 5.39.0 Lounge con struttura in frassino, scocca rivestita. — Lounge chair with frame in ash, upholstered shell.  
2.39.0 Poltroncina con struttura in frassino, scocca rivestita. — Armchair with frame in ash upholstered shell.



- 5.39.0 Lounge con struttura in frassino, scocca rivestita. — Lounge chair with frame in ash, upholstered shell.





2.39.0 Poltroncina con struttura in frassino, scocca rivestita. — Armchair with frame in ash, upholstered shell.  
B.39.Y Poltroncina girevole con struttura in metallo, scocca rivestita. — Swivel armchair with metal frame, upholstered shell.

E.39.Y Lounge girevole con struttura in metallo, scocca rivestita. — Swivel lounge chair with metal frame, upholstered shell.  
5.39.0 Lounge con struttura in frassino, scocca rivestita. — Lounge chair with frame in ash, upholstered shell.





2.39.0  
5.39.0



2.39.0



E.39.0  
B.39.0

2.39.0 Poltroncina con struttura in frassino, scocca rivestita. — Armchair with frame in ash, upholstered shell.  
5.39.0 Lounge con struttura in frassino, scocca rivestita. — Lounge chair with frame in ash, upholstered shell.

E.39.0 Lounge girevole con struttura in metallo, scocca rivestita. — Swivel lounge chair with metal frame, upholstered shell.  
B.39.0 Poltroncina girevole con struttura in metallo, scocca rivestita. — Swivel armchair with metal frame, upholstered shell.



B.39.0

**ANDREA STEIDL**  
 Andrea Steidl si laurea in Industrial Design al Politecnico di Milano. Intraprende subito la carriera presso lo studio di Patricia Urquiola, dove raggiunge il ruolo di Creative Manager fino al 2016. Nel 2016 con Raquel Pacchini fonda Studio / à r o / progettando per diverse aziende occupandosi di art direction, graphic design, installazioni e progettazione di prodotto industriale.

Andrea Steidl graduated from Politecnico di Milano with a degree in Industrial Design and began his career immediately at Patricia Urquiola's studio. He went on to become a Creative Manager and remained with the firm until 2016. In 2016, he founded the / à r o / design studio with Raquel Pacchini. They work for a range of companies in the fields of art direction, graphic design, installations and product design.



B.39.0 Poltroncina girevole con struttura in metallo, scocca rivestita.  
 — Swivel armchair with metal frame, upholstered shell.



E.39.0

E.39.0 Lounge girevole con struttura in metallo, scocca rivestita.  
 — Swivel lounge chair with metal frame, upholstered shell.





5.01.0



5.01.0



5.03.0



5.03.0

5.03.0 Lounge con struttura in frassino, sedile e schienale rivestito.  
— Lounge chair with frame in ash, upholstered seat and back.

5.03.0 Lounge con struttura in frassino, sedile e schienale rivestito.  
— Lounge chair with frame in ash, upholstered seat and back.









## NIKA

Nika riprende uno stile libero da qualsiasi vincolo temporale. Leggere nelle forme, le sedute di questa collezione interpretano con scioltezza e garbo le esigenze di ogni ambiente. Sedia, poltrona e sgabello sono caratterizzati da una solida ed armoniosa struttura in frassino e da un confortevole sedile rivestito in tessuto, pelle o intrecciato. Lo schienale curvato e il profilo delicato dei braccioli addolciscono una linea che riflette un'idea di comfort essenziale e sobria eleganza.

Categorie: sedia,  
poltrona, sgabello  
↳ p. 377  
Informazioni tecniche

Nika follows a style free from any time constraints. Light in shape, the seats of this collection interpret the needs of any environment with ease and grace. Chair, armchair and stool are characterised by a solid and harmonious ash structure and a comfortable seat upholstered in fabric, leather or woven. The curved backrest and the delicate profile of the armrests soften a line that reflects an idea of essential comfort and sober elegance.

Categories: chair,  
armchair, stool  
↳ p. 377  
Technical information





1.01.0 Sedia con struttura in frassino,  
sedile rivestito. — Chair  
with frame in ash, upholstered seat.

2.01.0 Poltrona con struttura in frassino,  
sedile rivestito. — Armchair  
with frame in ash, upholstered seat.

3.01.0 Sgabello con struttura in frassino,  
sedile rivestito. — Stool with  
frame in ash, upholstered seat.





3.01.0  
1.01.0

3.01.0 Sgabello con struttura in frassino, sedile rivestito. — Stool with frame in ash, upholstered seat.  
1.01.0 Sedia con struttura in frassino, sedile rivestito. — Chair with frame in ash, upholstered seat.

1.01.0



3.01.0



1.01.0 Sedia con struttura in frassino, sedile rivestito. — Chair with frame in ash, upholstered seat.  
3.01.0 Sgabello con struttura in frassino, sedile rivestito. — Stool with frame in ash, upholstered seat.



2.12.0

2.12.0 Poltrona con struttura in frassino, sedile in filato. — Armchair with frame in ash, paper cord seat.



1.12.0  
3.12.0  
2.12.0

1.12.0 Sedia con struttura in frassino, sedile in filato. — Chair with frame in ash, paper cord seat.

3.12.0 Sgabello con struttura in frassino, sedile in filato. — Stool with frame in ash, paper cord seat.  
2.12.0 Poltrona con struttura in frassino, sedile in filato. — Armchair with frame in ash, paper cord seat.







## STILO by Enzo Berti

Stilo, nata dalla creatività di Enzo Berti, esprime il comfort in chiave moderna e dinamica. Sottili fianchi in legno disegnano l'inconfondibile profilo che caratterizza l'intera collezione. Volumi leggeri enfatizzano la pulizia delle forme, morbide e accoglienti, e il rivestimento sartoriale in pelle o tessuto che si adatta alla struttura come un abito, sottolineandone la silhouette asciutta e precisa. Con la sua estetica marcata, Stilo conferisce un accento distintivo agli ambienti professionali e privati dedicati all'attesa e all'incontro. Sedia e lounge, con base girevole in metallo, si uniscono all'accoglienza dell'ottoman in una collezione che cattura lo sguardo con garbata eleganza e comfort ergonomico.

Categorie: sedia girevole,  
lounge girevole, ottoman  
↳ p. 393  
Informazioni tecniche

Stilo, born from the creativity of Enzo Berti, expresses comfort in a modern and dynamic way. Thin wooden sides draw the unique profile that characterises the entire collection. Light volumes emphasize the clean lines, soft and welcoming, and the tailored upholstery in leather or fabric adapts to the structure like a suit, highlighting its precise silhouette. With its marked aesthetics, Stilo gives a distinctive accent to professional and private environments dedicated to waiting and meeting. Chair and lounges, with a metal swivel base, combine with the warmth of the ottoman in a collection that catches the eye with graceful elegance and ergonomic comfort.

Categorie: swivel chair,  
swivel lounge chair, ottoman  
↳ p. 393  
Technical information



G.30.0  
B.30.0

- G.30.0 Lounge girevole con struttura in metallo, fianchi e braccioli in faggio, scocca rivestita. — Swivel lounge chair with metal frame, sides and armrests in beech, upholstered shell.
- B.30.0 Sedia girevole con struttura in metallo, fianchi e braccioli in faggio, scocca rivestita. — Swivel chair with metal frame, sides and armrests in beech, upholstered shell.



- G.30.A Lounge girevole con struttura in metallo, fianchi e braccioli in faggio, scocca e cuscino rivestiti. — Swivel lounge chair with metal frame, sides and armrests in beech, upholstered shell and cushion.





B.30.0



G.30.0

B.30.0 Sedia girevole con struttura in metallo, fianchi e braccioli in faggio, scocca rivestita. — Swivel chair with metal frame, sides and armrests in beech, upholstered shell.

G.30.0 Lounge girevole con struttura in metallo, fianchi e braccioli in faggio, scocca rivestita. — Swivel lounge chair with metal frame, sides and armrests in beech, upholstered shell.



A.30.0



A.30.0

A.30.0 Sedia girevole con struttura in metallo, fianchi in faggio, scocca rivestita.  
— Swivel chair with metal frame, sides in beech, upholstered shell.



E.30.0

E.30.0 Lounge girevole con struttura in metallo, fianchi in faggio, scocca rivestita.  
— Swivel lounge chair with metal frame, sides in beech, upholstered shell.





G.30.A

G.30.A Lounge girevole con struttura in metallo, fianchi e braccioli in faggio, scocca e cuscino rivestiti. — Swivel lounge chair with metal frame, sides and armrests in beech, upholstered shell and cushion.



8.01.0  
G.30.A

8.01.0 Ottoman con struttura in metallo, fianchi in faggio, sedile rivestito. — Ottoman with metal frame, sides in beech, upholstered seat.  
G.30.A Lounge girevole con struttura in metallo, fianchi e braccioli in faggio, scocca e cuscino rivestiti. — Swivel lounge chair with metal frame, sides and armrests in beech, upholstered shell and cushion.



E.30.A  
8.01.0

E.30.A Lounge girevole con struttura in metallo, fianchi in faggio, scocca e cuscino rivestiti. — Swivel lounge chair with metal frame, sides in beech, upholstered shell and cushion.  
8.01.0 Ottoman con struttura in metallo, fianchi in faggio, sedile rivestito. — Ottoman with frame in metal, sides in beech, upholstered seat



E.30.A



E.30.A

E.30.A Lounge girevole con struttura in metallo, fianchi in faggio, scocca e cuscino rivestiti. — Swivel lounge chair with metal frame, sides in beech, upholstered shell and cushion.





## HART by Christoph Jenni

Forme dai contorni leggeri incontrano il calore del legno e delle sue venature. Disegnata da Christoph Jenni, Hart è una collezione dalle linee semplici basata su un progetto costruttivo complesso. Hart si adatta a diverse combinazioni di colori e finiture. Sedia e poltroncina, impilabili, sono disponibili in legno o con seduta e schienale rivestiti. Lo sgabello, con o senza braccioli, completa una collezione in grado di unire eleganza e razionalità a una vasta gamma di possibilità.

Categorie: sedia, sedia impilabile, poltrona, poltrona impilabile, sgabello  
↳ p. 367  
Informazioni tecniche

Shapes with light contours meet the warmth of wood and its grain. Designed by Christoph Jenni, Hart is a collection with simple lines founded upon a complex construction project. Hart adapts to different combinations of colours and finishes. Stackable chair and armchair are available in wood or with upholstered seat and back. The stool, with or without armrests, completes a collection capable of combining elegance and rationality with a wide range of possibilities.

Categorie: chair, stackable chair, armchair, stackable armchair, stool  
↳ p. 367  
Technical information



2.02.1 Poltroncina impilabile con struttura, sedile e schienale in faggio.  
— Stackable armchair with frame, seat and back in beech.



2.23.1 Poltroncina impilabile con struttura in faggio, pannello sedile rivestito.  
— Stackable armchair with frame in beech, upholstered seat panel.





2.24.1 Poltroncina impilabile con struttura in faggio, pannello sedile e schienale rivestiti. — Stackable armchair with frame in beech, upholstered seat and back panels.



1.24.1 Sedia impilabile con struttura in faggio, pannello sedile e schienale rivestiti. — Stackable chair with frame in beech, upholstered seat and back panels.  
1.02.1 Sedia impilabile con struttura, sedile e schienale in faggio. — Stackable chair with frame, seat and back in beech.  
1.01.1 Sedia impilabile con struttura in faggio, sedile rivestito. — Stackable chair with frame in beech, upholstered seat.



3.09.0 Sgabello con struttura in faggio, sedile e schienale rivestiti. — Stool with frame in beech, upholstered seat and back.



3.01.0 Sgabello con struttura in faggio, sedile rivestito. — Stool with frame in beech, upholstered seat.  
3.14.0 Sgabello con struttura, sedile e schienale in faggio. — Stool with frame, seat and back in beech.





1.01.I  
1.02.I  
1.24.I



1.01.I  
1.24.I



2.02.I  
2.24.I

#### CHRISTOPH JENNI

Christoph è nato nel 1976 a Rio de Janeiro, Brasile. A 14 anni si è trasferito in Svizzera, dove ha studiato Disegno Industriale presso FHNW. Ha lavorato per 5 anni nello studio di Hannes Wettstein e nel 2012 ha aperto il suo studio a Berna. È docente presso l'HSLU di Lucerna. Christoph descrive il suo lavoro come una sintesi delle sue origini brasiliane e dell'educazione svizzera, che si combinano con la scrupolosità maturata durante l'esperienza lavorativa presso lo studio di Hannes Wettstein.

Christoph was born 1976 in Rio de Janeiro, Brasil. After moving to Switzerland at 14 he finished school in Switzerland and studied Industrial Design at FHNW. 5 years of working experience at Hannes Wettstein design studio followed, and in 2012 he opened his own Studio in Bern. He is a lecturer at HSLU in Lucerne. Christoph describes his work as a synthesis of his Brazilian heritage and Swiss education, combined with the scrupulousness gained during the work experience he made while working for Hannes Wettstein.



- 1.01.I Sedia impilabile con struttura in faggio, sedile rivestito. — Stackable chair with frame in beech, upholstered seat.
- 1.02.I Sedia impilabile con struttura, sedile e schienale in faggio. — Stackable chair with frame, seat and back in beech.
- 1.24.I Sedia impilabile con struttura in faggio, pannello sedile e schienale rivestiti. — Stackable chair with frame in beech, upholstered seat and back panels.

- 2.02.I Poltroncina impilabile con struttura, sedile e schienale in faggio. — Stackable armchair with frame, seat and back in beech.
- 2.24.I Poltroncina impilabile con struttura in faggio, pannello sedile e schienale rivestiti. — Stackable armchair with frame in beech, upholstered seat and back panels.





2.02.1

2.02.1 Poltroncina impilabile con struttura, sedile e schienale in faggio.  
— Stackable armchair with frame, seat and back in beech.



3.01.0  
3.09.0

3.01.0 Sgabello con struttura in faggio, sedile rivestito. — Stool with frame in beech, upholstered seat.  
3.09.0 Sgabello con struttura in faggio, sedile e schienale rivestiti.  
— Stool with frame in beech, upholstered seat and back panels.

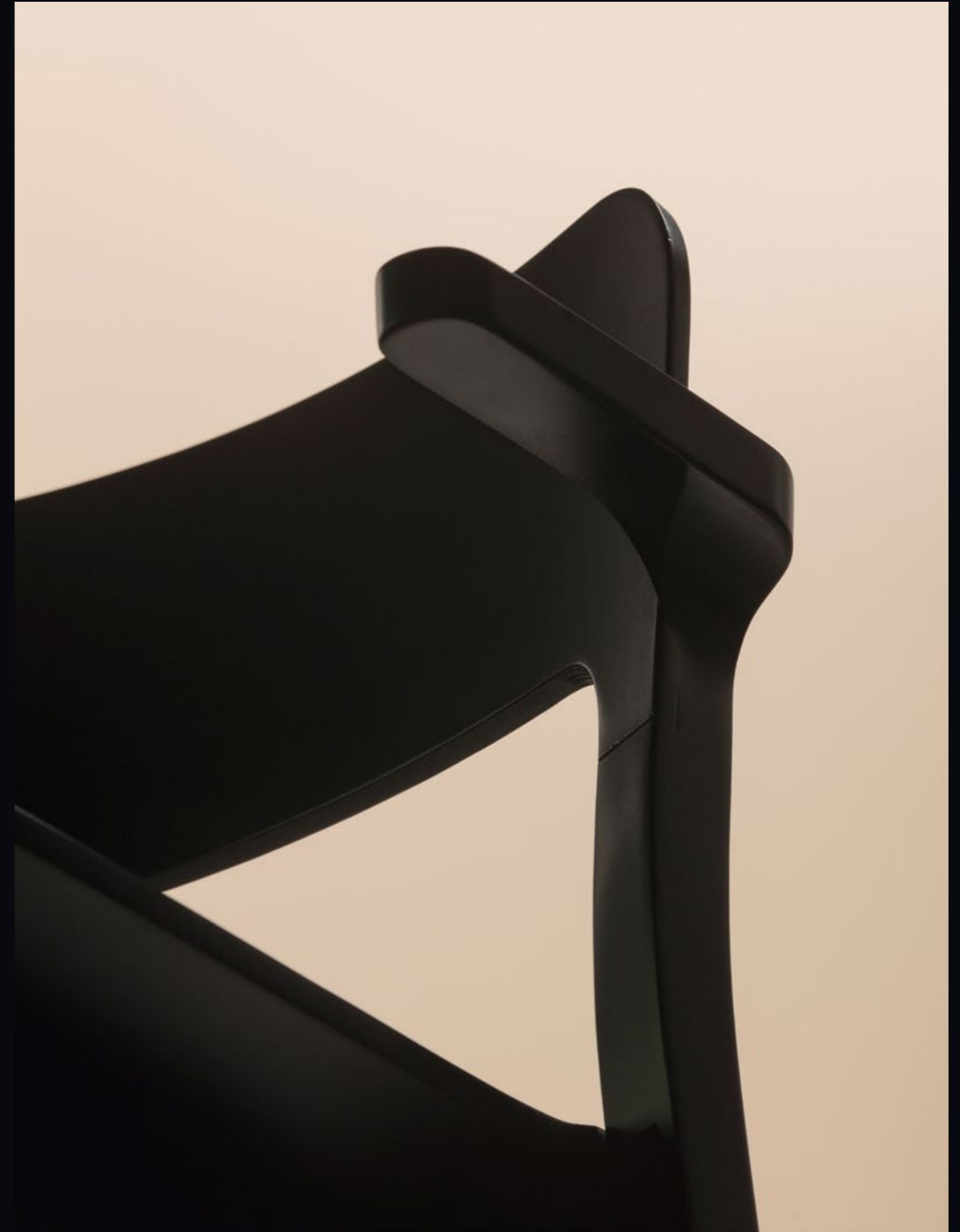



## FRIDA

Elegante e raffinata, Frida riesce a bilanciare leggerezza e solidità con un design che si delinea tra morbidi rivestimenti e dettagli curati: linee razionali e tratti espressivi portano comfort e relax in luoghi pubblici e privati. Il segno essenziale della struttura in legno bilancia la linea fluida e morbida di seduta e schienale, in un equilibrio costante tra solidità e leggerezza. Frida è una collezione che trova posto in diversi contesti grazie alla possibilità di personalizzare le combinazioni cromatiche di struttura e seduta imbottita.

Categorie: sedia, sedia girevole, poltrona, poltrona girevole, sgabello, sgabello girevole e regolabile, lounge, divano, panca, ottoman, bergère  
↳ p. 365  
Informazioni tecniche

Elegant and refined, Frida manages to balance lightness and solidity with a design that is outlined between soft upholstery and considered details: rational lines and expressive features bring comfort and relaxation to public and private places. The essential sign of the wooden structure balances the fluid and soft line of the seat and back, in a constant balance between solidity and lightness. Frida is a collection that finds its place in different contexts thanks to the possibility of customising the chromatic combinations of structure and upholstered seat.

Categorie: chair, swivel chair, armchair, swivel armchair, stool, swivel and adjustable stool, lounge chair, sofa, bench, ottoman, wingback chair  
↳ p. 365  
Technical information



1.03.0 Sedia con struttura in faggio, sedile e schienale rivestiti.  
— Chair with frame in beech, upholstered seat and back.



1.03.0 Sedia con struttura in faggio, sedile e schienale rivestiti.  
— Chair with frame in beech, upholstered seat and back.



2.03.0 Poltrona con struttura in faggio,  
sedile e schienale rivestiti.  
— Armchair with frame in beech,  
upholstered seat and back.

3.09.0 Sgabello con struttura in faggio,  
sedile e schienale rivestiti.  
— Stool with frame in beech,  
upholstered seat and back.

3.16.B Sgabello con struttura in faggio,  
sedile rivestito. — Stool with frame  
in beech, upholstered seat.  
3.03.0 Sgabello con struttura in faggio,  
sedile e schienale rivestiti. — Stool  
with frame in beech, upholstered  
seat and back.

1.03.0 Sedia con struttura in faggio,  
sedile e schienale rivestiti.  
— Chair with frame in beech,  
upholstered seat and back.





2.03.0

2.03.0 Poltrona con struttura in faggio,  
sedile e schienale rivestiti.  
— Armchair with frame in beech,  
upholstered seat and back.



2.03.0

2.03.0 Poltrona con struttura in faggio,  
sedile e schienale rivestiti.  
— Armchair with frame in beech,  
upholstered seat and back.



A.03.0  
B.03.0

- A.03.0 Sedia girevole con base in metallo, sedile e schienale rivestiti.  
— Swivel chair with metal frame, upholstered seat and back.
- B.03.0 Poltrona girevole con base in metallo, sedile e schienale rivestiti.  
— Swivel armchair with metal frame, upholstered seat and back.



B.03.0

- B.03.0 Poltrona girevole con base in metallo, sedile e schienale rivestiti.  
— Swivel armchair with metal frame, upholstered seat and back.



C.03.0/R  
C.09.0/R

- C.03.0/R Sgabello girevole e regolabile con base in metallo, sedile e schienale rivestiti.  
— Swivel and adjustable stool with metal frame, upholstered seat and back.
- C.09.0/R Sgabello girevole e regolabile con base in metallo, sedile e schienale rivestiti.  
— Swivel and adjustable stool with metal frame, upholstered seat and back.





5.09.0  
8.01.0

5.09.0 Lounge con struttura in faggio,  
sedile e schienale rivestiti.  
— Lounge chair with frame in beech,  
upholstered seat and back.  
8.01.0 Ottoman con struttura in faggio,  
sedile rivestito. — Ottoman with  
frame in beech, upholstered seat.



5.09.0

5.09.0 Lounge con struttura in faggio,  
sedile e schienale rivestiti.  
— Lounge chair with frame in beech,  
upholstered seat and back.



P.03.0



P.03.0  
8.01.0





3.09.0  
3.03.0

3.09.0 Sgabello con struttura in faggio, sedile e schienale rivestiti.  
— Stool with frame in beech, upholstered seat and back.  
3.03.0 Sgabello con struttura in faggio, sedile e schienale rivestiti.  
— Stool with frame in beech, upholstered seat and back.

6.03.0



7.01.0



6.03.0 Divano con struttura in faggio, sedile e schienale rivestiti. — Sofa with frame in beech, upholstered seat and back.  
7.01.0 Panca con struttura in faggio, sedile rivestito. — Bench with frame in beech, upholstered seat.

## WHY by LucidiPevere

Why interpreta l'essenza del legno, forte e resistente ma anche leggero e flessibile, attraverso un'espressione grafica essenziale, dall'estetica decisa e sinuosa. Segni definiti e lineari tracciano il profilo della struttura, forme armoniose e dettagli eleganti si combinano in un equilibrio semplice e pulito. La collezione di LucidiPevere trova posto in qualsiasi interno, dagli spazi legati all'ospitalità a quelli residenziali, più intimi e personali. Sedia e sgabello, con struttura in legno in varie finiture, incontrano i diversi rivestimenti disponibili, perfezionando un'eleganza invitante e raffinata.

Categorie: sedia, sgabello  
p. 405  
Informazioni tecniche

Why interprets the essence of wood, strong and resistant but also light and flexible, through an essential graphic expression, a decisive and sinuous aesthetic. Defined and linear signs trace the profile of the structure, harmonious shapes and elegant details combine in a simple and clean balance. The LucidiPevere collection finds its place in any interior, from public hospitality spaces, to more intimate and personal ones. Chair and stool, with structure in wood in various finishes, meet with different available coverings, perfecting an inviting and fine elegance.

Categorie: chair, stool  
p. 405  
Technical information



1.07.0 Sedia con struttura in frassino, sedile in laminato. — Chair with frame in ash, laminated seat.



1.02.0 Sedia con struttura e sedile in frassino. — Chair with frame and seat in ash.





1.23.0 Sedia con struttura in frassino, pannello sedile rivestito. — Chair with frame in ash, upholstered seat panel.  
1.02.0 Sedia con struttura e sedile in frassino. — Chair with frame and seat in ash.

3.23.0 Sgabello con struttura in frassino, pannello sedile rivestito. — Stool with frame in ash, upholstered seat panel.

3.24.0 Sgabello con struttura in frassino, pannelli sedile e schienale rivestiti. — Stool with frame in ash, upholstered seat and back panels.



1.02.0

1.02.0 Sedia con struttura e sedile in frassino. — Chair with frame and seat in ash.

1.23.0  
3.23.0



3.24.0



3.24.0 Sgabello con struttura in frassino, pannello sedile e schienale rivestiti. — Stool with frame in ash, upholstered seat and back panels.

1.23.0 Sedia con struttura in frassino, pannello sedile rivestito. — Chair with frame in ash, upholstered seat panel.  
3.23.0 Sgabello con struttura in frassino, pannello sedile rivestito. — Stool with frame in ash, upholstered seat panel.





## TIMBER by Adam Goodrum

Linee precise disegnano una figura solida e confortevole. Proporzioni equilibrate delineano una collezione che mostra come la semplicità possa esprimersi attraverso forme, rivestimenti e accostamenti diversi: Timber si presta a essere interpretata in base alle finiture in legno, pelle o tessuto e agli accostamenti tra colori e materiali, per entrare in spazi pubblici e privati che richiedono soluzioni concrete e durevoli. Progettata da Adam Goodrum, Timber è una famiglia da vivere in ambienti diversi, come locali e zone pranzo, angoli relax e sale riunioni. Una pratica sedia impilabile, con schienale disponibile in diverse versioni, si accompagna a sgabelli, poltrona e lounge in una collezione che asseconda le esigenze dello spazio in cui si inserirà grazie a un'accorta flessibilità e ampie possibilità di personalizzazione.

Precise lines draw a solid and comfortable figure. Balanced proportions outline a collection that shows how simplicity can be expressed through different shapes, coatings and combinations: Timber lends itself to being interpreted according to wood, leather or fabric finishes, and to the combinations of colours and materials to enter public and private spaces that require concrete and lasting solutions. Designed by Adam Goodrum, Timber lives perfectly in different environments, such as public spaces and dining areas, relaxation corners and meeting rooms. A practical stackable chair, with backrest available in different versions, is accompanied by stools, armchair and lounge in a collection that meets the needs of the space in which it will fit, thanks to careful flexibility and wide customisation possibilities.



Categorie: sedia, sedia impilabile, poltrona, poltrona impilabile, sgabello, lounge  
↳ p. 394  
Informazioni tecniche

Categorie: chair, stackable chair, armchair, stackable armchair, stool, lounge chair  
↳ p. 394  
Technical information

2.03.0-J Poltrona con struttura in faggio, sedile rivestito, schienale in faggio con pannello rivestito. — Armchair with frame in beech, upholstered seat, back in beech with upholstered panel.



2.01.0-J Poltrona con struttura in faggio, sedile rivestito. — Armchair with frame in beech, upholstered seat.





3.17.A-J Sgabello con struttura e sedile in faggio.  
— Stool with frame and seat in beech.  
3.01.0-X Sgabello con struttura in faggio, sedile  
rivestito. — Stool with frame in beech,  
upholstered seat.

2.03.0-J Poltrona con struttura in faggio, sedile  
rivestito, schienale in faggio con pannello  
rivestito. — Armchair with frame  
in beech, upholstered seat, back in  
beech with upholstered panel.

1.03.I-W Sedia impilabile con struttura in faggio, sedile  
e schienale rivestiti. — Stackable chair with frame  
in beech, upholstered seat and back.  
1.03.I-J Sedia impilabile con struttura in faggio, sedile  
rivestito, schienale in faggio con pannello rivestito.  
— Stackable chair with frame in beech, upholstered  
seat, back in beech with upholstered panel.

1.01.I-X Sedia impilabile con struttura in faggio,  
sedile rivestito. — Stackable chair with  
frame in beech, upholstered seat.



1.02.I-J



1.02.I-J



5.03.0-J

1.02.I-J Sedia impilabile con struttura e sedile in faggio. — Stackable chair with frame and seat in beech.

5.03.0-J Lounge con struttura in faggio, sedile rivestito, schienale in faggio con pannello rivestito. — Lounge chair with frame in beech, upholstered seat, back in beech with upholstered panel.





1.01.I-X



1.02.I-X



1.01.I-X  
1.02.I-X

1.01.I-X Sedia impilabile con struttura in faggio, sedile rivestito. — Stackable chair with frame in beech, upholstered seat.

**ADAM GOODRUM**

Adam Goodrum è cresciuto in Australia Occidentale e poi si è trasferito a Sydney per studiare Industrial Design. Concentrandosi sull'arredamento, sul prodotto e sull'interior design, il suo lavoro unisce funzionalità ed estetica.

Adam Goodrum grew up in Western Australia then moved to Sydney to study Industrial Design. Focusing on furniture, product and interior design, his work unifies functionality with aesthetic.



1.02.I-X Sedia impilabile con struttura e sedile in faggio. — Stackable chair with frame and seat in beech.

1.01.I-X Sedia impilabile con struttura in faggio, sedile rivestito. — Stackable chair with frame in beech, upholstered seat.



1.01.I-K  
1.02.I-K



1.03.I-W

1.01.I-K Sedia impilabile con struttura in faggio, sedile rivestito. — Stackable chair with frame in beech, upholstered seat.  
1.02.I-K Sedia impilabile con struttura e sedile in faggio. — Stackable chair with frame and seat in beech.

1.03.I-W Sedia impilabile con struttura in faggio, sedile e schienale rivestiti. — Stackable chair with frame in beech, upholstered seat and back.



3.03.0-W  
3.01.0-J  
3.01.0-X

3.03.0-W Sgabello con struttura in faggio, sedile e schienale rivestiti. — Stool with frame in beech, upholstered seat and back.

3.01.0-J Sgabello con struttura in faggio, sedile rivestito. — Stool with frame in beech, upholstered seat.  
3.01.0-X Sgabello con struttura in faggio, sedile rivestito. — Stool with frame in beech, upholstered seat.



## DIXIE

Una famiglia di sedute moderne e flessibili che delinea un modello di stile sempre attuale. Forme ergonomiche si inseriscono in linee semplici e accoglienti: la morbida seduta e l'avvolgente schienale della poltroncina diventano espressione di un design riconoscibile, in grado di farsi notare in qualsiasi ambiente senza risultare invadente. Dagli spazi domestici agli ambienti pubblici e conviviali, Dixie si fa testimone di comfort ed eleganza. Sedia e poltroncina sono personalizzabili grazie a un'ampia gamma di rivestimenti in pelle o tessuto. Lo sgabello si inserisce nella collezione confermando la perfetta armonia espressiva che lega tra loro i diversi elementi.

Categorie: sedia,  
poltrona, sgabello  
↳ p. 364  
Informazioni tecniche

A family of flexible seating that outlines an enduring contemporary style. Ergonomic shapes fit into simple and welcoming lines: the soft seat and the enveloping back of the armchair become the expression of a recognisable design, able to stand out in any environment without being intrusive. From domestic spaces to public and convivial environments, Dixie is a collection of comfort and elegance. Chair and armchair are fully customisable thanks to a wide variety of leather or fabric upholstery. The stool completes the collection, confirming the perfect expressive harmony that binds the different elements together.

Categorie: chair,  
armchair, stool  
↳ p. 364  
Technical information



2.03.0 Poltroncina con struttura in faggio,  
sedile e schienale rivestiti.  
— Amchair with frame in beech,  
upholstered seat and back.



2.03.0 Poltroncina con struttura in faggio,  
sedile e schienale rivestiti.  
— Amchair with frame in beech,  
upholstered seat and back.



1.03.0 Sedia con struttura in faggio,  
sedile e schienale rivestiti.  
— Chair with frame in beech,  
upholstered seat and back.

3.03.0 Sgabello con struttura in faggio,  
sedile e schienale rivestiti.  
— Stool with frame in beech,  
upholstered seat and back.

2.03.0 Poltroncina con struttura in faggio,  
sedile e schienale rivestiti.  
— Armchair with frame in beech,  
upholstered seat and back.

3.09.0 Sgabello con struttura in faggio, sedile  
e schienale rivestiti. — Stool with frame  
in beech, upholstered seat and back.





1.03.0

1.03.0 Sedia con struttura in faggio, sedile e schienale rivestiti.  
— Chair with frame in beech, upholstered seat and back.



3.03.0

3.03.0 Sgabello con struttura in faggio, sedile e schienale rivestiti.  
— Stool with frame in beech, upholstered seat and back.



3.03.0  
3.09.0

3.09.0 Sgabello con struttura in faggio, sedile e schienale rivestiti.  
— Stool with frame in beech, upholstered seat and back.

## VIKI

Confortevole e dal look accattivante, Viki è una collezione dal carattere fresco che si presta ad interpretare molte soluzioni personalizzate. Sedia e sgabello sono contraddistinti dallo schienale ergonomico in legno sostenuto da una struttura flessibile in metallo verniciato che offre una comoda postura. La versione con sedile imbottito completa la possibilità di creare esclusive combinazioni tra la calda texture del legno, raffinati tessuti e pelli disponibili in un'ampia gamma. Il tavolino, disponibile in due altezze, completa questa collezione fresca e funzionale, adatta a diversi ambienti e ideale per infondere un tocco elegante e giocoso in locali dedicati al relax e alla convivialità.

Categorie: sedia,  
sgabello, tavolo  
↳ p. 403  
Informazioni tecniche

With its comfortable and attractive look, Viki is a collection with a fresh personality that lends itself to interpreting many customised solutions. Chair and stool are characterised by the ergonomic wooden back, supported by a flexible painted metal structure that offers a comfortable posture. The versatile combination of exclusive finishes, the warm texture of wood, refined fabrics and wide range of leathers, is completed in the version of comfortable upholstered seat. The coffee table, available in two heights, completes this fresh and functional collection, suitable for different environments and ideal for instilling an elegant and playful touch in rooms dedicated to relaxation and conviviality.

Categorie: chair,  
stool, table  
↳ p. 403  
Technical information



1.01.0  
3.17.B

- 1.01.0 Sedia con struttura in faggio, supporto schienale in metallo, sedile rivestito. — Chair with frame in beech, back metal bracket, upholstered seat.
- 3.17.B Sgabello con struttura e sedile in faggio. — Stool with frame and seat in beech.



- 1.03.0 Sedia con struttura in faggio, supporto schienale in metallo, sedile e schienale rivestiti. — Chair with frame in beech, back metal bracket, upholstered seat and back.





3.02.0 Sgabello con struttura e sedile in faggio, supporto schienale in metallo. — Stool with frame and seat in beech, back metal bracket.  
 3.01.0 Sgabello con struttura in frassino (su richiesta), supporto schienale in metallo, sedile rivestito. — Stool with frame in ash (on request), back metal bracket, upholstered seat.

3.16.A Sgabello con struttura in faggio, sedile rivestito. — Stool with frame in beech, upholstered seat.

1.01.0 Sedia con struttura in frassino (su richiesta), supporto schienale in metallo, sedile rivestito. — Chair with frame in ash (on request), back metal bracket, upholstered seat.  
 1.02.0 Sedia con struttura, sedile e schienale in faggio, supporto schienale in metallo. In versione opzionale bicolore. — Chair with frame, seat and back in beech, back metal bracket. Optional two tone version.

9.40.A Tavolo con struttura in faggio, top in laminato. — Table with frame in beech, laminate top.  
 3.17.B Sgabello con struttura e sedile in faggio. — Stool with frame and seat in beech.



1.01.0  
1.03.0  
1.02.0

1.01.0 Sedia con struttura in frassino (su richiesta), supporto schienale in metallo, sedile rivestito. — Chair with frame in ash (on request), back metal bracket, upholstered seat.  
1.03.0 Sedia con struttura in faggio, supporto schienale in metallo, sedile e schienale rivestiti. — Chair with frame in beech, back metal bracket, upholstered seat and back.

1.02.0 Sedia con struttura, sedile e schienale in faggio, supporto schienale in metallo. In versione opzionale bicolore. — Chair with frame, seat and back in beech, back metal bracket. Optional two tone version.



1.01.0

1.01.0 Sedia con struttura in frassino (su richiesta), supporto schienale in metallo, sedile rivestito. — Chair with frame in ash (on request), back metal bracket, upholstered seat.





3.02.0  
3.03.0



3.02.0

- 3.02.0 Sgabello con struttura e sedile in faggio, supporto schienale in metallo. — Stool with frame and seat in beech, back metal bracket.
- 3.03.0 Sgabello con struttura in faggio, supporto schienale in metallo, sedile e schienale rivestiti. — Stool with frame in beech, back metal bracket, upholstered seat and back.



9.40.A  
9.40.B

- 9.40.A Tavolo con struttura in faggio, top in laminato. — Table with frame in beech, laminate top.
- 9.40.B Tavolo con struttura in faggio, top in laminato. — Table with frame in beech, laminate top.

## KARMA

Diversi volumi delineano proporzioni leggere ed equilibrate. Uno schienale dolcemente curvato, ricavato da un unico elemento di frassino, definisce un design che caratterizza l'intera collezione e trova nella poltrona, ampia e avvolgente, la sua massima espressione. Generosa senza essere ingombrante, valorizza qualsiasi interno con eleganza e dinamismo. Karma conferisce un'accoglienza senza tempo a spazi pubblici e residenziali. La seduta, intrecciata o rivestita, esalta i tratti minimali della struttura in legno, andando a rifinire il fascino semplice e sofisticato di questa confortevole famiglia di sedute.

Categorie: sedia,  
poltrona, sgabello  
↳ p. 374  
Informazioni tecniche

Different volumes outline light and balanced proportions. A gently curved backrest, made from a single element of ash, defines a design that characterises the entire collection and finds its maximum expression in the wide and enveloping armchair. Generous without being bulky, it enhances any interior with elegance and dynamism. Karma gives a timeless welcome to public and residential spaces. The seat, woven or upholstered, enhances the minimal features of the wooden structure, finishing the simple and sophisticated charm of this comfortable seating family.

Categorie: chair,  
armchair, stool  
↳ p. 374  
Technical information







1.01.0 Sedia con struttura in frassino,  
sedile rivestito. — Chair with frame  
in ash, upholstered seat.  
2.01.0 Poltrona con struttura in frassino,  
sedile rivestito. — Armchair  
with frame in ash, upholstered seat.

3.01.0 Sgabello con struttura in frassino,  
sedile rivestito. — Stool with  
frame in ash, upholstered seat.

2.01.0 Poltrona con struttura in frassino,  
sedile rivestito. — Armchair  
with frame in ash, upholstered seat.



2.01.0

2.01.0 Poltrona con struttura in frassino, sedile rivestito. — Armchair with frame in ash, upholstered seat.



2.12.0  
1.12.0  
3.12.0

2.12.0 Poltrona con struttura in frassino, sedile in filato. — Armchair with frame in ash, paper cord seat.  
1.12.0 Sedia con struttura in frassino, sedile in filato. — Chair with frame in ash, paper cord seat.



2.12.0

3.12.0 Sgabello con struttura in frassino, sedile in filato. — Stool with frame in ash, paper cord seat.





1.01.0

1.01.0 Sedia con struttura in frassino, sedile rivestito. — Chair with frame in ash, upholstered seat.

3.01.0



3.01.0



3.01.0 Sgabello con struttura in frassino, sedile rivestito. — Stool with frame in ash, upholstered seat.





## LEA

Essenziale nel design, quanto confortevole nella seduta, Lea si esprime attraverso una figura che combina estetica moderna e assoluta semplicità funzionale. Rigide geometrie confluiscono in morbidi rivestimenti imbottiti che lasciano trasparire un senso di ricercata eleganza e comfort essenziale. Una collezione di sedute confortevoli e raffinate derivata da un pensiero che fonde ergonomia ed eleganza delle proporzioni. Con sedia, poltrona e sgabello realizzabili in varie finiture e rivestimenti, Lea si presta ad arredare diversi ambienti.

Categorie: sedia, sedia girevole,  
poltrona, poltrona girevole,  
sgabello, sgabello girevole e regolabile  
↳ p. 375  
Informazioni tecniche

Essential in design and comfortable in seat, Lea expresses itself through a figure that combines modern aesthetics and absolute functional simplicity. Rigid geometries converge in soft padded coverings that reveal a sense of refined elegance and essential comfort. A comfortable and refined collection derived from a thought that blends ergonomics and elegance of proportions. With chair, armchair and stool completed in various finishes and coverings, Lea lends itself to furnishing different environments.

Categorie: chair, swivel chair,  
armchair, swivel armchair,  
stool, swivel and adjustable stool  
↳ p. 375  
Technical information



2.03.0 Poltrona con struttura in faggio, sedile e schienale rivestiti. — Armchair with frame in beech, upholstered seat and back.



2.03.0 Poltrona con struttura in faggio, sedile e schienale rivestiti. — Armchair with frame in beech, upholstered seat and back.





1.03.0 Sedia con struttura in faggio, sedile e schienale rivestiti. — Chair with frame in beech, upholstered seat and back.  
3.03.0 Sgabello con struttura in faggio, sedile e schienale rivestiti. — Stool with frame in beech, upholstered seat and back.

3.09.0 Sgabello con struttura in faggio, sedile e schienale rivestiti. — Stool with frame in beech, upholstered seat and back.

2.03.0 Poltrona con struttura in faggio, sedile e schienale rivestiti. — Armchair with frame in beech, upholstered seat and back.





2.03.0  
1.03.0

2.03.0 Poltrona con struttura in faggio, sedile e schienale rivestiti. — Armchair with frame in beech, upholstered seat and back.  
1.03.0 Sedia con struttura in faggio, sedile e schienale rivestiti. — Chair with frame in beech, upholstered seat and back.



3.09.0  
3.03.0

3.09.0 Sgabello con struttura in faggio, sedile e schienale rivestiti. — Stool with frame in beech, upholstered seat and back.  
3.03.0 Sgabello con struttura in faggio, sedile e schienale rivestiti. — Stool with frame in beech, upholstered seat and back.



B.03.0  
A.03.0

B.03.0 Poltrona girevole con struttura in metallo, sedile e schienale rivestiti. — Swivel armchair with metal frame, upholstered seat and back.  
A.03.0 Sedia girevole con struttura in metallo, sedile e schienale rivestiti. — Swivel chair with metal frame, upholstered seat and back.



C.09.0/R



C.09.0/R  
C.03.0/R

C.09.0/R Sgabello girevole e regolabile con base in metallo, sedile e schienale rivestiti. — Swivel and adjustable stool with metal base, upholstered seat and back.  
C.03.0/R Sgabello girevole e regolabile con base in metallo, sedile e schienale rivestiti. — Swivel and adjustable stool with metal base, upholstered seat and back.



## INGA

Con la sua struttura semplice, pulita e lineare, Inga trasmette leggerezza e serenità. La sua figura snella, ma robusta, è esaltata da un profilo elegante in netta contrapposizione con la rigidità della struttura. La poltroncina, impilabile come la sedia, si distingue per la sagoma dei braccioli, dotati di un carattere proprio e specifico. Le sfumature del legno e i materiali scelti per il rivestimento sottolineano un'estetica ordinata, funzionale e rassicurante che infonde calore e solidità: sensazioni che Inga riesce a portare con estrema naturalezza in qualsiasi interno si collochi.

With its simple, clean and linear structure, Inga conveys lightness and serenity. Its slim but robust figure is enhanced by an elegant profile in stark contrast to the rigidity of the structure. The armchair, stackable like the chair, is distinguished by the shape of the armrests, which have their own particular character. The shades of the wood and the materials chosen for the upholstery emphasize an orderly, functional and reassuring aesthetic that infuses warmth and solidity: sensations that Inga manages to bring with effortless naturalness to any interior it resides.



Categorie: sedia, sedia impilabile, poltrona, poltrona impilabile, sgabello  
↳ p. 372  
Informazioni tecniche

Categorie: chair, stackable chair, armchair, stackable armchair, stool  
↳ p. 372  
Technical information

1.01.I Sedia impilabile con struttura in faggio, sedile rivestito. — Stackable chair with frame in beech, upholstered seat.



1.03.I Sedia impilabile con struttura in faggio, sedile rivestito e schienale con pannello rivestito. — Stackable chair with frame in beech, upholstered seat, back with upholstered panel.



- 1.01.1 Sedia impilabile con struttura in faggio, sedile rivestito. — Stackable chair with frame in beech, upholstered seat.
- 2.01.1 Poltroncina impilabile con struttura in faggio, sedile rivestito. — Stackable armchair with frame in beech, upholstered seat.

- 3.02.0 Sgabello con struttura in faggio, sedile e schienale in faggio. — Stool with frame in beech, seat and back in beech.

- 3.01.0 Sgabello con struttura in faggio, sedile rivestito. — Stool with frame in beech, upholstered seat.





2.01.1



2.01.1



3.01.0

## SEELI

Una famiglia di sedute accomunate da un'estetica sobria ed equilibrata, espressione di una personalità solida e funzionale al tempo stesso, pensate per gli ambienti della convivialità. Sedia, poltrona e sgabello con struttura in faggio, tutte con seduta e schienali dalla forma ergonomica, disponibili anche nella versione rivestita in tessuto o pelle, per assicurare il massimo comfort. Il design curato e la vasta scelta di finiture fanno di Seeli una famiglia perfetta per arredare con eleganza e stile luoghi e contesti diversi.

Categorie: sedia,  
poltrona, sgabello  
↳ p. 390  
Informazioni tecniche

Designed for convivial environments, this collection united by a pure and balanced aesthetic, express a solid and functional personality. Chair, armchair and stool with beech frame, all with ergonomically shaped seat and backrests are also available in the version with upholstery in fabric or leather, to ensure maximum comfort. The careful design and the wide choice of finishes make Seeli a perfect family to furnish different places and contexts with elegance and style.

Categorie: chair,  
armchair, stool  
↳ p. 390  
Technical information



2.03.0 Poltroncina con struttura in faggio, sedile rivestito, schienale in faggio con pannello rivestito. — Armchair with frame in beech, upholstered seat, back in beech with upholstered panel.

2.03.0 Poltroncina con struttura in faggio, sedile rivestito, schienale in faggio con pannello rivestito. — Armchair with frame in beech, upholstered seat, back in beech with upholstered panel.





3.02.0 Sgabello con struttura e sedile in faggio.  
— Stool with frame and seat in beech.

3.03.0 Sgabello con struttura in faggio, sedile rivestito,  
schienale in faggio con pannello rivestito.  
— Stool with frame in beech, upholstered seat,  
back in beech with upholstered panel.

1.01.0 Sedia con struttura in faggio,  
sedile rivestito. — Chair with frame  
in beech, upholstered seat.

2.02.0 Poltroncina con struttura e sedile  
in faggio. — Armchair with  
frame, seat and back in beech.

1.03.0 Sedia con struttura in faggio, sedile  
rivestito, schienale in faggio con  
pannello rivestito. — Chair with frame  
in beech, upholstered seat, back  
in beech with upholstered panel.



1.01.0



1.03.0



1.03.0  
1.02.0

- 1.01.0 Sedia con struttura in faggio, sedile rivestito. — Chair with frame in beech, upholstered seat.
- 1.03.0 Sedia con struttura in faggio, sedile rivestito, schienale in faggio con pannello rivestito. — Chair with frame in beech, upholstered seat, back in beech with upholstered panel.

- 1.03.0 Sedia con struttura in faggio, sedile rivestito, schienale in faggio con pannello rivestito. — Chair with frame in beech, upholstered seat, back in beech with upholstered panel.
- 1.02.0 Sedia con struttura e sedile in faggio. — Chair with frame, seat and back in beech.





3.01.0  
3.03.0



3.01.0



3.03.0

3.01.0 Sgabello con struttura in faggio, sedile rivestito. — Stool with frame in beech, upholstered seat.  
3.03.0 Sgabello con struttura in faggio, sedile rivestito, schienale in faggio con pannello rivestito. — Stool with frame in beech, upholstered seat, back in beech with upholstered panel.

3.01.0 Sgabello con struttura in faggio, sedile rivestito. — Stool with frame in beech, upholstered seat.  
3.03.0 Sgabello con struttura in faggio, sedile rivestito, schienale in faggio con pannello rivestito. — Stool with frame in beech, upholstered seat, back in beech with upholstered panel.



Outdoor Collection





## COCO

Coco è una collezione pensata per arredare terrazze e spazi aperti di bar, ristoranti e hotel con lo stesso appeal di un'area living o di un salotto. Una linea di sedute derivata dal design concettuale di Coco che, con il suo equilibrio di forme leggere e volumi morbidi, rappresenta la risposta ideale alla crescente esigenza di vivere gli spazi esterni come un'estensione degli ambienti interni. La struttura è in metallo, trattato per resistere agli agenti atmosferici e realizzabile in varie tinte. L'imbottitura in gomma offre un appoggio confortevole garantendo al tempo stesso l'impermeabilità del materiale, rivestito con tessuti idrorepellenti selezionati per qualità e caratteristiche estetiche. La comoda eleganza di Coco si esprime nel prevalere delle forme arrotondate, che la rendono una famiglia di sedute accogliente, dal mood fresco e dinamico, seppur robusta e funzionale, per arredare con stile gli spazi outdoor pubblici e privati.

Categorie: sedia,  
poltrona, sgabello, lounge,  
panca, ottoman  
p. 362  
Informazioni tecniche

Coco is a collection designed to furnish terraces and open spaces of bars, restaurants and hotels with the same appeal of a living area or lounge. A seating line derived from Coco's conceptual design which, with its balance of light shapes and soft volumes, represents the ideal response to the growing need to experience outdoor spaces as an extension of indoor environments. The structure in metal is treated to resist atmospheric agents and can be specified in a variety of colours. The foam padding offers a comfortable support while ensuring the impermeability of the material, upholstered with water-repellent fabrics selected for quality and aesthetic characteristics. The comfortable elegance of Coco is expressed in the prevalence of rounded shapes, which make it a welcoming collection, with a fresh and dynamic mood, albeit robust and functional, to furnish public and private outdoor spaces with style.

Categorie: chair,  
armchair, stool, lounge chair,  
bench, ottoman  
p. 362  
Technical information



2.03.Z/O Poltroncina con struttura in metallo, sedile e schienale rivestiti. — Armchair with metal frame, upholstered seat and back.



2.03.Z/O Poltroncina con struttura in metallo, sedile e schienale rivestiti. — Armchair with metal frame, upholstered seat and back.

1.03.Z/O Sedia con struttura in metallo, sedile e schienale rivestiti. — Chair with metal frame, upholstered seat and back.



5.03.Z/O Lounge con struttura in metallo, sedile e schienale rivestiti. — Lounge chair with metal frame, upholstered seat and back.  
 8.01.Z/O Ottoman con struttura in metallo, sedile rivestito. — Ottoman with metal frame, upholstered seat.

2.03.Z/O Poltroncina con struttura in metallo, sedile e schienale rivestiti. — Armchair with metal frame, upholstered seat and back.  
 1.03.Z/O Sedia con struttura in metallo, sedile e schienale rivestiti. — Chair with metal frame, upholstered seat and back.

3.03.Z/O Sgabello con struttura in metallo, sedile e schienale rivestiti. — Stool with metal frame, upholstered seat and back.  
 3.09.Z/O Sgabello con struttura in metallo, sedile e schienale rivestiti. — Stool with metal frame, upholstered seat and back.

7.01.Z/O Panca con struttura in metallo, sedile rivestito. — Bench with metal frame, upholstered seat.





2.03.Z/O  
3.16.B/Z/O



7.01.Z/O

2.03.Z/O Poltrona con struttura in metallo, sedile e schienale rivestiti. — Armchair with metal frame, upholstered seat and back.  
3.16.B/Z/O Sgabello con struttura in metallo, sedile rivestito. — Stool with metal frame, upholstered seat.

7.01.Z/O Panca con struttura in metallo, sedile rivestito. — Bench with metal frame, upholstered seat.



5.03.Z/O  
8.01.Z/O

5.03.Z/O Lounge con struttura in metallo, sedile e schienale rivestiti. — Lounge chair with metal frame, upholstered seat and back.  
8.01.Z/O Ottoman con struttura in metallo, sedile rivestito. — Ottoman with metal frame, upholstered seat.

5.03.Z/O



5.03.Z/O



5.03.Z/O Lounge con struttura in metallo, sedile e schienale rivestiti. — Lounge chair with metal frame, upholstered seat and back.





3.09.Z/O



3.09.Z/O

3.09.Z/O  
3.03.Z/O



## BABA

Tratti sottili ed essenziali si combinano in una struttura semplice e funzionale. Linee morbide e sinuose disegnano una scocca continua ed ergonomica. Baba porta comfort, leggerezza e flessibilità anche negli spazi esterni che necessitano di dinamismo e praticità: da un estroverso locale estivo al plateatico di un bistrot, da un evento formale a situazioni poliedriche che richiedono rapidi spostamenti e trasformazioni. Baba è un sistema di sedute che coglie le esigenze degli ambienti all'aperto e le reinterpreta con energia e personalità. Sedie impilabili e sgabelli sono realizzati con materiali appositamente trattati per resistere agli agenti atmosferici: la struttura in metallo, disponibile in versione slitta o quattro gambe, le gomme e i rivestimenti idrorepellenti garantiscono soluzioni resistenti e configurabili per qualsiasi contesto all'aria aperta.

Categorie: sedia, sedia impilabile, sgabello, sgabello impilabile  
↳ p. 358  
Informazioni tecniche

Subtle and essential features combine in a simple and functional structure. Soft and sinuous lines draw a continuous and ergonomic shell. Baba brings comfort, lightness and flexibility to interior and exterior environments alike that require dynamism and practicality: from an extroverted summer club to the stalls of a bistro, from formal events to multipurpose situations that require rapid transitions in layout. Baba is a seating system that captures the needs of outdoor environments and reinterprets them with energy and personality. Stackable chairs and stools are made with materials specially treated to withstand atmospheric agents: the metal structure, available in a sled or four-legged version, the foam and water-repellent coatings guarantee resistant and configurable solutions for any outdoor setting.



1.30.ZS/I/O Sedia impilabile con struttura in metallo, scocca rivestita. — Stackable chair with metal frame, upholstered shell.



Categorie: sedia, sedia impilabile, sgabello, sgabello impilabile  
↳ p. 358  
Informazioni tecniche

1.30.ZS/I/O Sedia impilabile con struttura in metallo, scocca rivestita. — Stackable chair with metal frame, upholstered shell.





1.30.ZS/1/O Sedia impilabile con struttura in metallo, scocca rivestita. – Stackable chair with metal frame, upholstered shell.

1.30.Z/O Sedia impilabile con struttura in metallo, scocca rivestita. – Stackable chair with metal frame, upholstered shell.

3.30.ZS/1/O Sgabello impilabile con base in metallo, scocca rivestita. – Stackable stool with metal base, upholstered shell.

3.30.Z/O Sgabello con base in metallo, scocca rivestita. – Stool with metal base, upholstered shell.



1.30.ZS/1/O

Nella foto in versione con gancio opzionale.  
Image, optional version with linking system.

1.30.ZS/1/O Sedia impilabile con struttura in metallo,  
scocca rivestita. – Stackable chair  
with metal frame, upholstered shell.



1.30.Z/1/O

1.30.Z/1/O Sedia impilabile con struttura in metallo,  
scocca rivestita. – Stackable chair  
with metal frame, upholstered shell.



1.30.Z/1/O





3.30.ZS/1/O  
3.30.Z/O

3.30.ZS/1/O Sgabello impilabile con base in metallo,  
scocca rivestita. — Stackable stool  
with metal base, upholstered shell.  
3.30.Z/O Sgabello con base in metallo,  
scocca rivestita. — Stool with metal  
base, upholstered shell.

3.30.ZS/1/O



3.30.ZS/1/O



3.30.ZS/1/O Sgabello impilabile con base in metallo,  
scocca rivestita. — Stackable stool  
with metal base, upholstered shell.

Informazioni tecniche 353  
 Technical information

Materiali e finiture 412  
 Materials and finishes

A	Arco	353
B	Baba	354
C	Coco	359
	Cori	363
D	Dixie	364
F	Fly	364
	Frida	365
H	Hart	367
	Hyppo	370
I	Inga	372
K	Karma	374
L	Lea	375
M	Maki	376
N	Nika	377
O	Obi	378
P	Palmo	379
R	Ribbon	383
S	Seeli	390
	Sprint	392
	Stilo	393
T	Timber	394
	Tipi	397
	Tuilli	402
V	Viki	403
W	Why	405
Y	Yumi	407

Outdoor

B	Baba	358
C	Coco	362

Arco



Misure (cm) Measurements (cm)	Categoria Category	Struttura Structure	Descrizione Description
Arco 	Cod. 1.01.1 Sedia impilabile	Faggio	Sedile: rivestito. Schienale: legno.
	Cod. 1.01.1 Stackable chair	Beech	Seat: upholstered. Back: wood.
Arco 	Cod. 1.02.1 Sedia impilabile	Faggio	Sedile: legno. Schienale: legno.
	Cod. 1.02.1 Stackable chair	Beech	Seat: wood. Back: wood.
Arco 	Cod. 1.03.1 Sedia impilabile	Faggio	Sedile: rivestito. Schienale: legno rivestito.
	Cod. 1.03.1 Stackable chair	Beech	Seat: upholstered. Back: upholstered wood.
Arco 	Cod. 1.04.1 Sedia impilabile	Faggio	Sedile: legno. Schienale: legno rivestito.
	Cod. 1.04.1 Stackable chair	Beech	Seat: wood. Back: upholstered wood.
Arco 	Cod. 3.01.0 Sgabello	Faggio	Sedile: rivestito. Schienale: legno.
	Cod. 3.01.0 Stool	Beech	Seat: upholstered. Back: wood.
Arco 	Cod. 3.02.0 Sgabello	Faggio	Sedile: legno. Schienale: legno.
	Cod. 3.02.0 Stool	Beech	Seat: wood. Back: wood.
Arco 	Cod. 3.03.0 Sgabello	Faggio	Sedile: rivestito. Schienale: legno rivestito.
	Cod. 3.03.0 Stool	Beech	Seat: upholstered. Back: upholstered wood.
Arco 	Cod. 3.04.0 Sgabello	Faggio	Sedile: legno. Schienale: legno rivestito.
	Cod. 3.04.0 Stool	Beech	Seat: wood. Back: upholstered wood.

Legenda  
Keys

Impilabile  
Stackable

Bicolore  
Bicolour

Agganciabile  
Linking

Con ruote  
With wheels



Baba



Misure (cm) Measurements (cm)	Categoria Category	Struttura Structure	Descrizione Description
<b>Baba</b>	Cod. 1.30.0 Sedia	Faggio	Scocca legno rivestita.
	Cod. 1.30.0 Chair	Beech	Upholstered wooden shell.



<b>Baba</b>	Cod. 1.31.0 Sedia	Faggio	Scocca legno.
	Cod. 1.31.0 Chair	Beech	Wooden shell.



<b>Baba</b>	Cod. 1.32.0 Sedia	Faggio	Scocca legno e pannello rivestito.
	Cod. 1.32.0 Chair	Beech	Wooden shell and upholstered panel.



<b>Baba</b>	Cod. 1.37.0 Sedia	Faggio	Scocca legno e pannello sedile rivestito.
	Cod. 1.37.0 Chair	Beech	Wooden shell and upholstered seat panel.



<b>Baba</b>	Cod. 1.30.Z/1 Sedia impilabile	Metallo	Scocca legno rivestita.
	Cod. 1.30.Z/1 Stackable chair	Metal	Upholstered wooden shell.



<b>Baba</b>	Cod. 1.31.Z/1 Sedia impilabile	Metallo	Scocca legno.
	Cod. 1.31.Z/1 Stackable chair	Metal	Wooden shell.



<b>Baba</b>	Cod. 1.32.Z/1 Sedia impilabile	Metallo	Scocca legno e pannello rivestito.
	Cod. 1.32.Z/1 Stackable chair	Metal	Wooden shell and upholstered panel.



<b>Baba</b>	Cod. 1.37.Z/1 Sedia impilabile	Metallo	Scocca legno e pannello sedile rivestito.
	Cod. 1.37.Z/1 Stackable chair	Metal	Wooden shell and upholstered seat panel.

Baba



Misure (cm) Measurements (cm)	Categoria Category	Struttura Structure	Descrizione Description
<b>Baba</b>	Cod. 1.30.ZS/1 Sedia impilabile	Metallo	Scocca legno rivestita.
	Cod. 1.30.ZS/1 Stackable chair	Metal	Upholstered wooden shell.



<b>Baba</b>	Cod. 1.31.ZS/1 Sedia impilabile	Metallo	Scocca legno.
	Cod. 1.31.ZS/1 Stackable chair	Metal	Wooden shell.



<b>Baba</b>	Cod. 1.32.ZS/1 Sedia impilabile	Metallo	Scocca legno e pannello rivestito.
	Cod. 1.32.ZS/1 Stackable chair	Metal	Wooden shell and upholstered panel.



<b>Baba</b>	Cod. 1.37.ZS/1 Sedia impilabile	Metallo	Scocca legno e pannello sedile rivestito.
	Cod. 1.37.ZS/1 Stackable chair	Metal	Wooden shell and upholstered seat panel.



<b>Baba</b>	Cod. A.30.0 Sedia girevole	Metallo	Scocca legno rivestita. Versione opzionale con ruote.
	Cod. A.30.0 Swivel chair	Metal	Upholstered wooden shell. Optional: castors.



<b>Baba</b>	Cod. A.31.0 Sedia girevole	Metallo	Scocca legno. Versione opzionale con ruote.
	Cod. A.31.0 Swivel chair	Metal	Wooden shell. Optional: castors.



<b>Baba</b>	Cod. A.32.0 Sedia girevole	Metallo	Scocca legno e pannello rivestito. Versione opzionale con ruote.
	Cod. A.32.0 Swivel chair	Metal	Wooden shell and upholstered panel. Optional: castors.



<b>Baba</b>	Cod. A.37.0 Sedia girevole	Metallo	Scocca legno e pannello sedile rivestito. Versione opzionale con ruote.
	Cod. A.37.0 Swivel chair	Metal	Wooden shell and upholstered seat panel. Optional: castors.

Baba



Misure (cm)  
Measurements (cm)

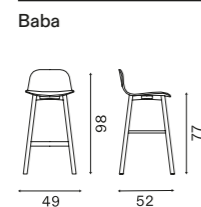

Categoria  
Category

Cod. 3.30.0  
Sgabello



Struttura  
Structure

Faggio

Beech

Descrizione  
Description

Scocca legno rivestita.

Upholstered wooden shell.

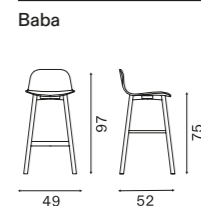

Cod. 3.31.0  
Sgabello

Cod. 3.31.0  
Stool



Faggio

Beech

Scocca legno.

Wooden shell.

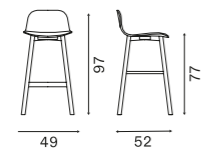

Cod. 3.32.0  
Sgabello

Cod. 3.32.0  
Stool



Faggio

Beech

Scocca legno e pannello rivestito.

Wooden shell and upholstered panel.

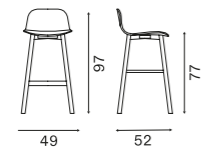

Cod. 3.37.0  
Sgabello

Cod. 3.37.0  
Stool



Faggio

Beech

Scocca legno e pannello sedile rivestito.

Wooden shell and upholstered seat panel.

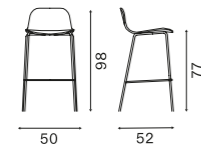

Cod. 3.30.Z  
Sgabello

Cod. 3.30.Z  
Stool



Metallo

Metal

Scocca legno rivestita.

Upholstered wooden shell.

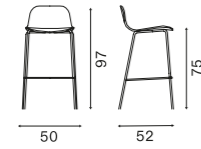

Cod. 3.31.Z  
Sgabello

Cod. 3.31.Z  
Stool



Metallo

Metal

Scocca legno.

Wooden shell.

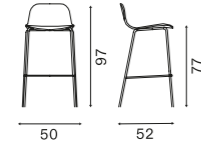

Cod. 3.32.Z  
Sgabello

Cod. 3.32.Z  
Stool



Metallo

Metal

Scocca legno e pannello rivestito.

Wooden shell and upholstered panel.

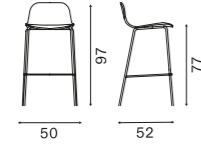

Cod. 3.37.Z  
Sgabello

Cod. 3.37.Z  
Stool



Metallo

Metal

Scocca legno e pannello sedile rivestito.

Wooden shell and upholstered seat panel.

Baba



Misure (cm)  
Measurements (cm)

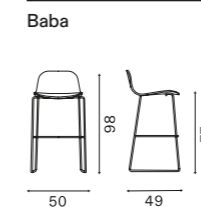

Categoria  
Category

Cod. 3.30.ZS/1  
Sgabello impilabile



Struttura  
Structure

Metallo

Metal

Descrizione  
Description

Scocca legno rivestita.

Upholstered wooden shell.

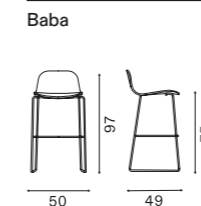

Cod. 3.31.ZS/1  
Sgabello impilabile

Cod. 3.31.ZS/1  
Stackable stool



Metallo

Metal

Scocca legno.

Wooden shell.

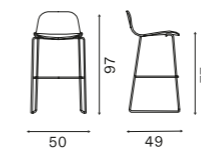

Cod. 3.32.ZS/1  
Sgabello impilabile

Cod. 3.32.ZS/1  
Stackable stool



Metallo

Metal

Scocca legno e pannello rivestito.

Wooden shell and upholstered panel.

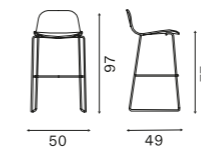

Cod. 3.37.ZS/1  
Sgabello impilabile

Cod. 3.37.ZS/1  
Stackable stool



Metallo

Metal

Scocca legno e pannello sedile rivestito.

Wooden shell and upholstered seat panel.

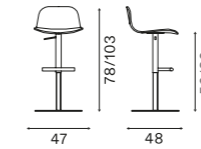

Cod. C.30.0/R  
Sgabello girevole e regolabile

Cod. C.30.0/R  
Swivel and adjustable stool



Metallo

Metal

Scocca legno rivestita.

Upholstered wooden shell.

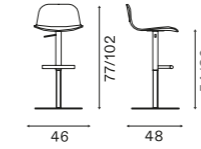

Cod. C.31.0/R  
Sgabello girevole e regolabile

Cod. C.31.0/R  
Swivel and adjustable stool



Metallo

Metal

Scocca legno.

Wooden shell.

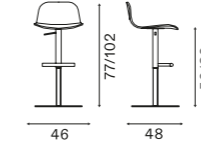

Cod. C.32.0/R  
Sgabello girevole e regolabile

Cod. C.32.0/R  
Swivel and adjustable stool



Metallo

Metal

Scocca legno e pannello rivestito.

Wooden shell and upholstered panel.

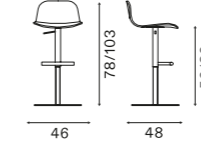

Cod. C.37.0/R  
Sgabello girevole e regolabile

Cod. C.37.0/R  
Swivel and adjustable stool



Metallo







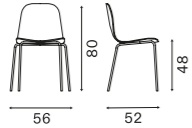

Metal

Scocca legno e pannello sedile rivestito.

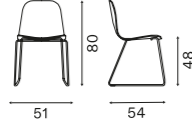

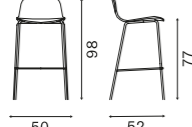

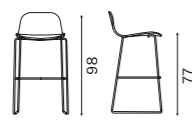
Wooden shell and upholstered seat panel.





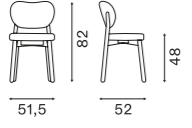

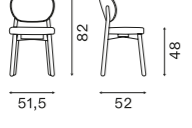

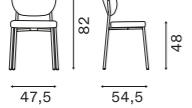



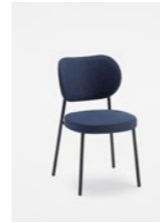
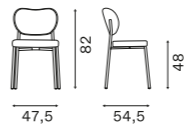

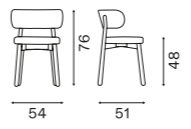

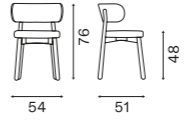

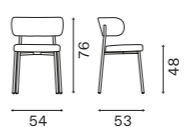
## Baba Outdoor

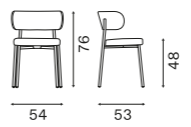
Misure (cm) Measurements (cm)	Categoria Category	Struttura Structure	Descrizione Description
	<b>Baba Outdoor</b> Cod. 1.30.Z/1/O Sedia impilabile Stackable chair	Metallo Metal	Scocca legno rivestita. Upholstered wooden shell.
			
	<b>Baba Outdoor</b> Cod. 1.30.ZS/1/O Sedia impilabile Stackable chair	Metallo Metal	Scocca legno rivestita. Upholstered wooden shell.
			
	<b>Baba Outdoor</b> Cod. 3.30.Z/O Sgabello Stool	Metallo Metal	Scocca legno rivestita. Upholstered wooden shell.
			
	<b>Baba Outdoor</b> Cod. 3.30.ZS/1/O Sgabello impilabile Stackable stool	Metallo Metal	Scocca legno rivestita. Upholstered wooden shell.
			

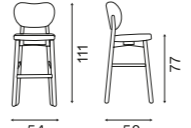

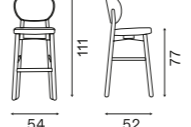







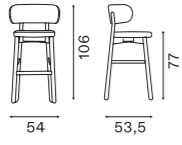

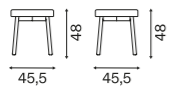
## Coco

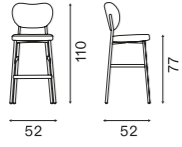
Misure (cm) Measurements (cm)	Categoria Category	Struttura Structure	Descrizione Description
	<b>Coco</b> Cod. 1.03.0 Sedia Chair	Faggio Beech	Sedile: rivestito. Schienale: rivestito. Seat: upholstered. Back: upholstered.
			
	<b>Coco</b> Cod. 1.05.0 Sedia Chair	Faggio Beech	Sedile: rivestito. Schienale: legno rivestito frontalmente. Seat: upholstered. Back: wood with upholstered pad.
			
	<b>Coco</b> Cod. 1.03.Z Sedia Chair	Metallo Metal	Sedile: rivestito. Schienale: rivestito. Seat: upholstered. Back: upholstered.
			

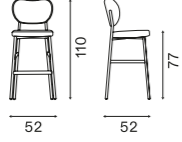

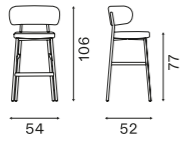

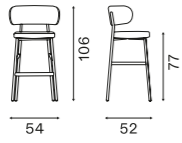

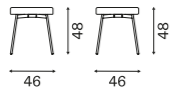

## Coco

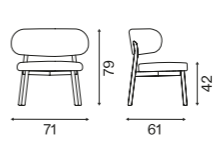
Misure (cm) Measurements (cm)	Categoria Category	Struttura Structure	Descrizione Description
	<b>Coco</b> Cod. 1.05.Z Sedia Chair	Metallo Metal	Sedile: rivestito. Schienale: legno rivestito frontalmente. Seat: upholstered. Back: wood with upholstered pad.
			
	<b>Coco</b> Cod. 2.03.0 Poltrona Armchair	Faggio Beech	Sedile: rivestito. Schienale: rivestito. Seat: upholstered. Back: upholstered.
			
	<b>Coco</b> Cod. 2.05.0 Poltrona Armchair	Faggio Beech	Sedile: rivestito. Schienale: legno rivestito frontalmente. Seat: upholstered. Back: wood with upholstered pad.
			
	<b>Coco</b> Cod. 2.03.Z Poltrona Armchair	Metallo Metal	Sedile: rivestito. Schienale: rivestito. Seat: upholstered. Back: upholstered.
			
	<b>Coco</b> Cod. 2.05.Z Poltrona Armchair	Metallo Metal	Sedile: rivestito. Schienale: legno rivestito frontalmente. Seat: upholstered. Back: wood with upholstered pad.
			
	<b>Coco</b> Cod. 3.03.0 Sgabello Stool	Faggio Beech	Sedile: rivestito. Schienale: rivestito. Seat: upholstered. Back: upholstered.
			
	<b>Coco</b> Cod. 3.05.0 Sgabello Stool	Faggio Beech	Sedile: rivestito. Schienale: legno rivestito frontalmente. Seat: upholstered. Back: wood with upholstered pad.
			
	<b>Coco</b> Cod. 3.09.0 Sgabello Stool	Faggio Beech	Sedile: rivestito. Schienale: rivestito. Seat: upholstered. Back: upholstered.
			

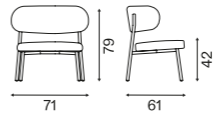
## Coco

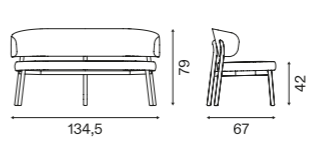

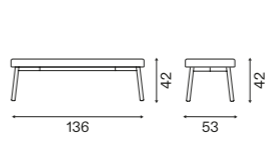

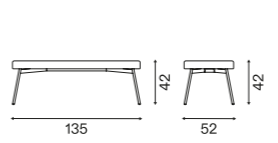
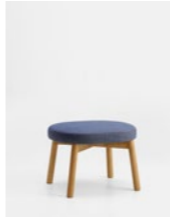
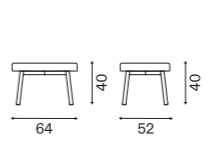
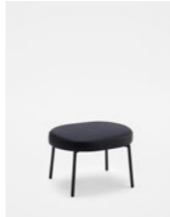
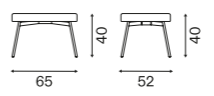





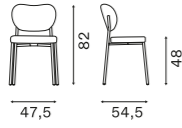

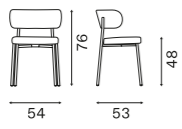

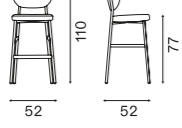
Misure (cm) Measurements (cm)	Categoria Category	Struttura Structure	Descrizione Description
	Coco	Faggio	Sedile: rivestito. Schienale: legno rivestito frontalmente.
	Cod. 3.10.0 Sgabello	Beech	Seat: upholstered. Back: wood with upholstered pad.
	Coco	Faggio	Sedile: rivestito.
	Cod. 3.16.B Sgabello	Beech	Seat: upholstered.
	Coco	Metallo	Sedile: rivestito. Schienale: rivestito.
	Cod. 3.03.Z Sgabello	Metal	Seat: upholstered. Back: upholstered.
	Coco	Metallo	Sedile: rivestito. Schienale: legno rivestito frontalmente.
	Cod. 3.05.Z Sgabello	Metal	Seat: upholstered. Back: wood with upholstered pad.
	Coco	Metallo	Sedile: rivestito. Schienale: rivestito.
	Cod. 3.09.Z Sgabello	Metal	Seat: upholstered. Back: upholstered.
	Coco	Metallo	Sedile: rivestito. Schienale: legno rivestito frontalmente.
	Cod. 3.10.Z Sgabello	Metal	Seat: upholstered. Back: wood with upholstered pad.
	Coco	Metallo	Sedile: rivestito.
	Cod. 3.16.B/Z Sgabello	Metal	Seat: upholstered.

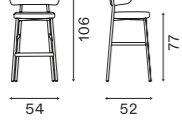
## Coco

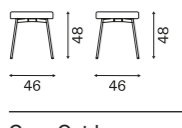

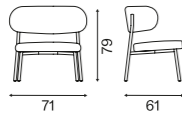

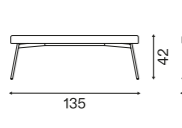

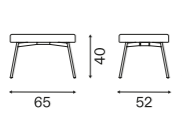

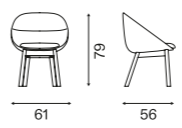
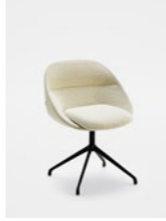
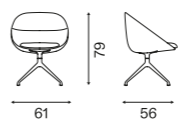
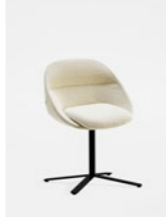
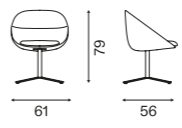

Misure (cm) Measurements (cm)	Categoria Category	Struttura Structure	Descrizione Description
	Coco	Faggio	Sedile: rivestito. Schienale: rivestito.
	Cod. 5.03.0 Lounge	Beech	Seat: upholstered. Back: upholstered.
	Coco	Metallo	Sedile: rivestito. Schienale: rivestito.
	Cod. 5.03.Z Lounge chair	Metal	Seat: upholstered. Back: upholstered.
	Coco	Faggio	Sedile: rivestito. Schienale: rivestito.
	Cod. 6.03.0 Divano	Beech	Seat: upholstered. Back: upholstered.
	Coco	Faggio	Sedile: rivestito.
	Cod. 7.01.0 Panca	Beech	Seat: upholstered.
	Coco	Metallo	Sedile: rivestito.
	Cod. 7.01.Z Panca	Metal	Seat: upholstered.
	Coco	Faggio	Sedile: rivestito.
	Cod. 8.01.0 Ottoman	Beech	Seat: upholstered.
	Coco	Metallo	Sedile: rivestito.
	Cod. 8.01.Z Ottoman	Metal	Seat: upholstered.

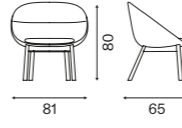

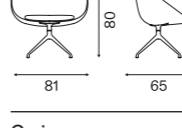
## Coco Outdoor

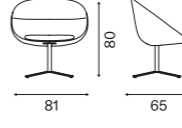
Misure (cm) Measurements (cm)	Categoria Category	Struttura Structure	Descrizione Description
 	Coco Outdoor Cod. 1.03.Z/O Sedia Cod. 1.03.Z/O Chair	Metallo Metal	Sedile: rivestito. Schienale: rivestito. Seat: upholstered. Back: upholstered.
 	Coco Outdoor Cod. 2.03.Z/O Poltrona Cod. 2.03.Z/O Armchair	Metallo Metal	Sedile: rivestito. Schienale: rivestito. Seat: upholstered. Back: upholstered.
 	Coco Outdoor Cod. 3.03.Z/O Sgabello Cod. 3.03.Z/O Stool	Metallo Metal	Sedile: rivestito. Schienale: rivestito. Seat: upholstered. Back: upholstered.
 	Coco Outdoor Cod. 3.09.Z/O Sgabello Cod. 3.09.Z/O Stool	Metallo Metal	Sedile: rivestito. Schienale: rivestito. Seat: upholstered. Back: upholstered.
 	Coco Outdoor Cod. 3.16.B/Z/O Sgabello Cod. 3.16.B/Z/O Stool	Metallo Metal	Sedile: rivestito. Seat: upholstered.
 	Coco Outdoor Cod. 5.03.Z/O Lounge Cod. 5.03.Z/O Lounge chair	Metallo Metal	Sedile: rivestito. Schienale: rivestito. Seat: upholstered. Back: upholstered.
 	Coco Outdoor Cod. 7.01.Z/O Panca Cod. 7.01.Z/O Bench	Metallo Metal	Sedile: rivestito. Seat: upholstered.
 	Coco Outdoor Cod. 8.01.Z/O Ottoman Cod. 8.01.Z/O Ottoman	Metallo Metal	Sedile: rivestito. Seat: upholstered.

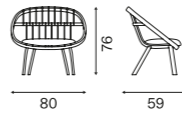
## Cori

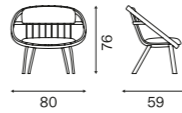
Misure (cm) Measurements (cm)	Categoria Category	Struttura Structure	Descrizione Description
 	Cori Cod. 2.39.0 Poltrona Cod. 2.39.0 Armchair	Frassino Ash	Sedile: rivestito. Schienale: rivestito. Seat: upholstered. Back: upholstered.
 	Cori Cod. B.39.0 Poltrona girevole Cod. B.39.0 Swivel armchair	Metallo Metal	Sedile: rivestito. Schienale: rivestito. Versione opzionale con ruote. Seat: upholstered. Back: upholstered. Optional: castors.
 	Cori Cod. B.39.Y Poltrona girevole Cod. B.39.Y Swivel armchair	Metallo Metal	Sedile: rivestito. Schienale: rivestito. Seat: upholstered. Back: upholstered.
 	Cori Cod. 5.39.0 Lounge Cod. 5.39.0 Lounge chair	Frassino Ash	Sedile: rivestito. Schienale: rivestito. Seat: upholstered. Back: upholstered.
 	Cori Cod. E.39.0 Lounge girevole Cod. E.39.0 Swivel lounge chair	Metallo Metal	Sedile: rivestito. Schienale: rivestito. Seat: upholstered. Back: upholstered.
 	Cori Cod. E.39.Y Lounge girevole Cod. E.39.Y Swivel lounge chair	Metallo Metal	Sedile: rivestito. Schienale: rivestito. Seat: upholstered. Back: upholstered.
 	Cori Cod. 5.01.0 Lounge Cod. 5.01.0 Lounge chair	Frassino Ash	Sedile: rivestito. Seat: upholstered.
 	Cori Cod. 5.03.0 Lounge Cod. 5.03.0 Lounge chair	Frassino Ash	Sedile: rivestito. Schienale: rivestito. Seat: upholstered. Back: upholstered.

## Dixie

Misure (cm) Measurements (cm)	Categoria Category	Struttura Structure	Descrizione Description
	Cod. 1.03.0 Sedia	Faggio	Sedile: rivestito. Schienale: rivestito.
	Cod. 1.03.0 Chair	Beech	Seat: upholstered. Back: upholstered.
	Cod. 2.03.0 Poltrona	Faggio	Sedile: rivestito. Schienale: rivestito.
	Cod. 2.03.0 Armchair	Beech	Seat: upholstered. Back: upholstered.
	Cod. 3.03.0 Sgabello	Faggio	Sedile: rivestito. Schienale: rivestito.
	Cod. 3.03.0 Stool	Beech	Seat: upholstered. Back: upholstered.
	Cod. 3.09.0 Sgabello	Faggio	Sedile: rivestito. Schienale: rivestito.
	Cod. 3.09.0 Stool	Beech	Seat: upholstered. Back: upholstered.

## Fly

Misure (cm) Measurements (cm)	Categoria Category	Struttura Structure	Descrizione Description
	Cod. 1.01.1 Sedia impilabile	Faggio	Sedile: rivestito. Schienale: legno.
	Cod. 1.01.1 Stackable chair	Beech	Seat: upholstered. Back: wood.
	Cod. 1.02.1 Sedia impilabile	Faggio	Sedile: legno. Schienale: legno.
	Cod. 1.02.1 Stackable chair	Beech	Seat: wood. Back: wood.
	Cod. 1.03.1 Sedia impilabile	Faggio	Sedile: rivestito. Schienale: legno e pannello rivestito.
	Cod. 1.03.1 Stackable chair	Beech	Seat: upholstered. Back: wood and upholstered panel.

## Fly











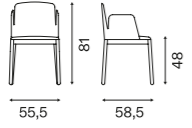

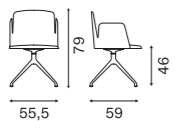

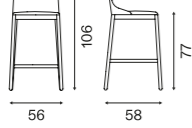
Misure (cm) Measurements (cm)	Categoria Category	Struttura Structure	Descrizione Description
	Cod. 1.04.1 Sedia impilabile	Faggio	Sedile: legno. Schienale: legno e pannello rivestito.
	Cod. 1.04.1 Stackable chair	Beech	Seat: wood. Back: wood and upholstered panel.
	Cod. 3.01.0 Sgabello	Faggio	Sedile: rivestito. Schienale: legno.
	Cod. 3.01.0 Stool	Beech	Seat: upholstered. Back: wood.
	Cod. 3.02.0 Sgabello	Faggio	Sedile: legno. Schienale: legno.
	Cod. 3.02.0 Stool	Beech	Seat: wood. Back: wood.
	Cod. 3.03.0 Sgabello	Faggio	Sedile: rivestito. Schienale: legno e pannello rivestito.
	Cod. 3.03.0 Stool	Beech	Seat: upholstered. Back: wood and upholstered panel.
	Cod. 3.04.0 Sgabello	Faggio	Sedile: legno. Schienale: legno e pannello rivestito.
	Cod. 3.04.0 Stool	Beech	Seat: wood. Back: wood and upholstered panel.

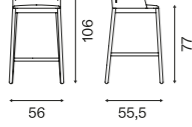
## Frida

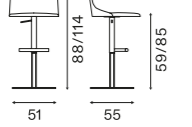

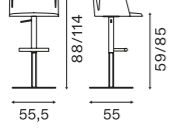

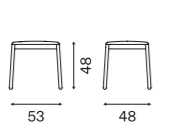

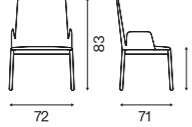
Misure (cm) Measurements (cm)	Categoria Category	Struttura Structure	Descrizione Description
	Cod. 1.03.0 Sedia	Faggio	Sedile: rivestito. Schienale: rivestito.
	Cod. 1.03.0 Chair	Beech	Seat: upholstered. Back: upholstered.
	Cod. A.03.0 Sedia girevole	Metallo	Sedile: rivestito. Schienale: rivestito. Versione opzionale con ruote.
	Cod. A.03.0 Swivel chair	Metal	Seat: upholstered. Back: upholstered. Optional: castors.



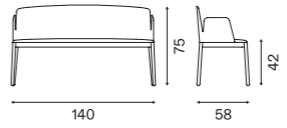

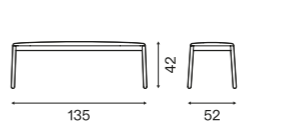

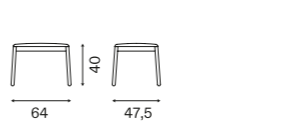
## Frida

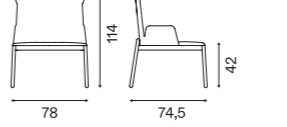
Misure (cm) Measurements (cm)	Categoria Category	Struttura Structure	Descrizione Description
 	Cod. 2.03.0 Poltrona Cod. 2.03.0 Armchair	Faggio Beech	Sedile: rivestito. Schienale: rivestito. Seat: upholstered. Back: upholstered.
 	Cod. B.03.0 Poltrona girevole Cod. B.03.0 Swivel armchair	Metallo Metal	Sedile: rivestito. Schienale: rivestito. Versione opzionale con ruote. Optional: castors.
 	Cod. 3.03.0 Sgabello Cod. 3.03.0 Stool	Faggio Beech	Sedile: rivestito. Schienale: rivestito. Seat: upholstered. Back: upholstered.
 	Cod. 3.09.0 Sgabello Cod. 3.09.0 Stool	Faggio Beech	Sedile: rivestito. Schienale: rivestito. Seat: upholstered. Back: upholstered.
 	Cod. C.03.0/R Sgabello girevole e regolabile Cod. C.03.0/R Swivel and adjustable stool	Metallo Metal	Sedile: rivestito. Schienale: rivestito. Seat: upholstered. Back: upholstered.
 	Cod. C.09.0/R Sgabello girevole e regolabile Cod. C.09.0/R Swivel and adjustable stool	Metallo Metal	Sedile: rivestito. Schienale: rivestito. Seat: upholstered. Back: upholstered.
 	Cod. 3.16.B Sgabello Cod. 3.16.B Stool	Faggio Beech	Sedile: rivestito. Seat: upholstered.
 	Cod. 5.09.0 Lounge Cod. 5.09.0 Lounge chair	Faggio Beech	Sedile: rivestito. Schienale: rivestito. Seat: upholstered. Back: upholstered.



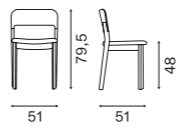

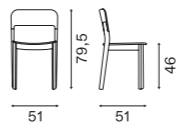

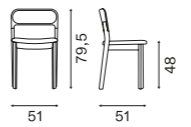



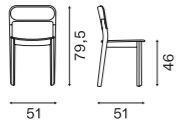

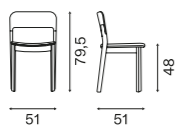

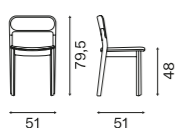
## Frida

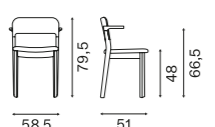
Misure (cm) Measurements (cm)	Categoria Category	Struttura Structure	Descrizione Description
 	Cod. 6.03.0 Divano Cod. 6.03.0 Sofa	Faggio Beech	Sedile: rivestito. Schienale: rivestito. Seat: upholstered. Back: upholstered.
 	Cod. 7.01.0 Panca Cod. 7.01.0 Bench	Faggio Beech	Sedile: rivestito. Seat: upholstered.
 	Cod. 8.01.0 Ottoman Cod. 8.01.0 Ottoman	Faggio Beech	Sedile: rivestito. Seat: upholstered.
 	Cod. P.03.0 Bergère Cod. P.03.0 Wingback Chair	Faggio Beech	Sedile: rivestito. Schienale: rivestito. Seat: upholstered. Back: upholstered.

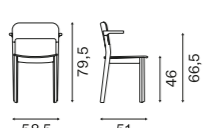
## Hart

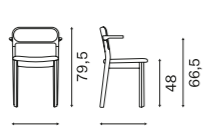
Misure (cm) Measurements (cm)	Categoria Category	Struttura Structure	Descrizione Description
 	Cod. 1.01.1 Sedia impilabile Cod. 1.01.1 Stackable chair	Faggio Beech	Sedile: rivestito. Schienale: legno. Seat: upholstered. Back: wood.
 	Cod. 1.02.1 Sedia impilabile Cod. 1.02.1 Stackable chair	Faggio Beech	Sedile: legno. Schienale: legno. Seat: wood. Back: wood.
 	Cod. 1.03.1 Sedia impilabile Cod. 1.03.1 Stackable chair	Faggio Beech	Sedile: rivestito. Schienale: legno con pannello rivestito. Seat: upholstered. Back: wood with upholstered panel.

Hart

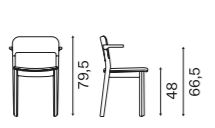
Misure (cm) Measurements (cm)	Categoria Category	Struttura Structure	Descrizione Description
	<b>Hart</b> Cod. 1.04.I Sedia impilabile Stackable chair	Faggio Beech	Sedile: legno. Schienale: legno con pannello rivestito. Seat: wood. Back: wood with upholstered panel.
			
	<b>Hart</b> Cod. 1.23.I Sedia impilabile Stackable chair	Faggio Beech	Sedile: legno con pannello rivestito. Schienale: legno. Seat: wood with upholstered panel. Back: wood.
			
	<b>Hart</b> Cod. 1.24.I Sedia impilabile Stackable chair	Faggio Beech	Sedile: legno con pannello rivestito. Schienale: legno con pannello rivestito. Seat: wood with upholstered panel. Back: wood with upholstered panel.
			
	<b>Hart</b> Cod. 2.01.I Poltrona impilabile Stackable armchair	Faggio Beech	Sedile: rivestito. Schienale: legno. Seat: upholstered. Back: wood.
			
	<b>Hart</b> Cod. 2.02.I Poltrona impilabile Stackable armchair	Faggio Beech	Sedile: legno. Schienale: legno. Seat: wood. Back: wood.
			
	<b>Hart</b> Cod. 2.03.I Poltrona impilabile Stackable armchair	Faggio Beech	Sedile: rivestito. Schienale: legno con pannello rivestito. Seat: upholstered. Back: wood with upholstered panel.
			
	<b>Hart</b> Cod. 2.04.I Poltrona impilabile Stackable armchair	Faggio Beech	Sedile: legno. Schienale: legno con pannello rivestito. Seat: wood. Back: wood with upholstered panel.
			
	<b>Hart</b> Cod. 2.23.I Poltrona impilabile Stackable armchair	Faggio Beech	Sedile: legno con pannello rivestito. Schienale: legno. Seat: wood with upholstered panel. Back: wood.
			

Hart

Misure (cm) Measurements (cm)	Categoria Category	Struttura Structure	Descrizione Description
	<b>Hart</b> Cod. 2.24.I Poltrona impilabile Stackable armchair	Faggio Beech	Sedile: legno con pannello rivestito. Schienale: legno con pannello rivestito. Seat: wood with upholstered panel. Back: wood with upholstered panel.
			
	<b>Hart</b> Cod. 3.01.0 Sgabello Stool	Faggio Beech	Sedile: rivestito. Schienale: legno. Seat: upholstered. Back: wood.
			
	<b>Hart</b> Cod. 3.02.0 Sgabello Stool	Faggio Beech	Sedile: legno. Schienale: legno. Seat: wood. Back: wood.
			
	<b>Hart</b> Cod. 3.03.0 Sgabello Stool	Faggio Beech	Sedile: rivestito. Schienale: legno con pannello rivestito. Seat: upholstered. Back: wood with upholstered panel.
			
	<b>Hart</b> Cod. 3.04.0 Sgabello Stool	Faggio Beech	Sedile: legno. Schienale: legno con pannello rivestito. Seat: wood. Back: wood with upholstered panel.
			
	<b>Hart</b> Cod. 3.23.0 Sgabello Stool	Faggio Beech	Sedile: legno con pannello rivestito. Schienale: legno. Seat: wood with upholstered panel. Back: wood.
			
	<b>Hart</b> Cod. 3.24.0 Sgabello Stool	Faggio Beech	Sedile: legno con pannello rivestito. Schienale: legno con pannello rivestito. Seat: wood with upholstered panel. Back: wood with upholstered panel.
			
	<b>Hart</b> Cod. 3.09.0 Sgabello Stool	Faggio Beech	Sedile: rivestito. Schienale: legno con pannello rivestito. Seat: upholstered. Back: wood with upholstered panel.
			



## Hart



Misure (cm)  
Measurements (cm)

Hart

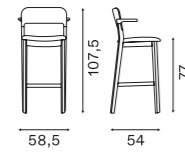

Categoria  
Category

Cod. 3.13.0  
Sgabello

Struttura  
Structure

Faggio

Descrizione  
Description

Sedile: rivestito.  
Schienale: legno.

Cod. 3.13.0  
Stool

Beech

Seat: upholstered.  
Back: wood.

Hart

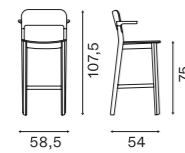

Cod. 3.14.0  
Sgabello

Faggio

Sedile: legno.  
Schienale: legno.

Cod. 3.14.0  
Stool

Beech

Seat: wood.  
Back: wood.



Hart

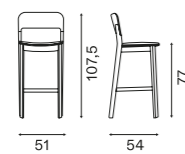

Cod. 3.26.0  
Sgabello

Faggio

Sedile: legno con pannello rivestito.  
Schienale: legno.

Cod. 3.26.0  
Stool

Beech

Seat: wood with upholstered panel.  
Back: wood.

Hart

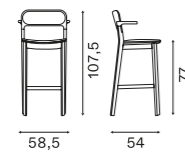

Cod. 3.27.0  
Sgabello

Faggio

Sedile: legno con pannello rivestito.  
Schienale: legno con pannello rivestito.

Cod. 3.27.0  
Stool

Beech

Seat: wood with upholstered panel.  
Back: wood with upholstered panel.

Hart

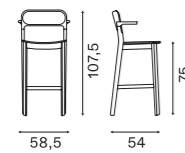

Cod. 3.28.0  
Sgabello

Faggio

Sedile: legno.  
Schienale: legno con pannello rivestito.

Cod. 3.28.0  
Stool

Beech

Seat: wood.  
Back: wood with upholstered panel.

## Hyppo



Misure (cm)  
Measurements (cm)

Hyppo

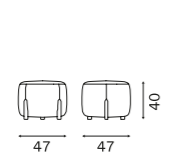

Categoria  
Category

Cod. 4.01.TL  
Pouf

Struttura  
Structure

Faggio

Descrizione  
Description

Sedile: rivestito.

Cod. 4.01.TL  
Pouf

Beech

Seat: upholstered.

Hyppo

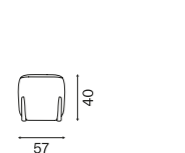

Cod. 4.01.PL  
Pouf

Faggio

Sedile: rivestito.

Cod. 4.01.PL  
Pouf

Beech

Seat: upholstered.

## Hyppo



Misure (cm)  
Measurements (cm)

Hyppo

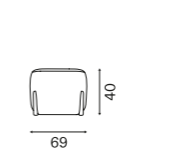

Categoria  
Category

Cod. 4.01.ML  
Pouf

Struttura  
Structure

Faggio

Descrizione  
Description

Sedile: rivestito.

Cod. 4.01.ML  
Pouf

Beech

Seat: upholstered.

Hyppo

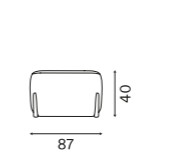

Cod. 4.01.GL  
Pouf

Faggio

Sedile: rivestito.

Cod. 4.01.GL  
Pouf

Beech

Seat: upholstered.

Hyppo

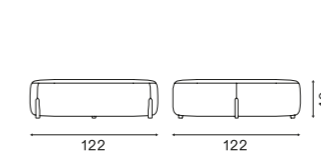

Cod. 4.01.RL  
Pouf

Faggio

Sedile: rivestito.

Cod. 4.01.RL  
Pouf

Beech

Seat: upholstered.

Hyppo

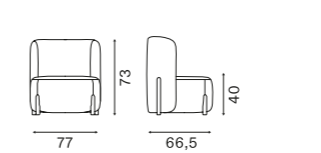

Cod. 5.03.L  
Lounge

Faggio

Sedile: rivestito.  
Schienale: rivestito.

Cod. 5.03.L  
Lounge chair

Beech

Seat: upholstered.  
Back: upholstered.

Hyppo

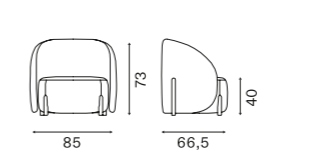

Cod. 5.09.L  
Lounge

Faggio

Sedile: rivestito.  
Schienale: rivestito.

Cod. 5.09.L  
Lounge chair

Beech

Seat: upholstered.  
Back: upholstered.

Hyppo

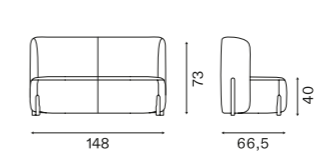

Cod. 6.03.L  
Divano

Faggio

Sedile: rivestito.  
Schienale: rivestito.

Cod. 6.03.L  
Sofa

Beech

Seat: upholstered.  
Back: upholstered.

Hyppo

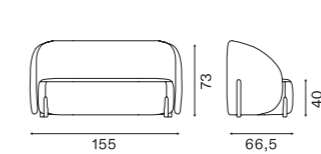

Cod. 6.09.L  
Divano

Faggio

Sedile: rivestito.  
Schienale: rivestito.

Cod. 6.09.L  
Sofa

Beech

Seat: upholstered.  
Back: upholstered.

Hyppo

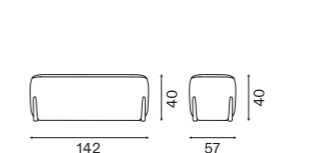

Cod. 7.01.L  
Panca

Faggio

Sedile: rivestito.

Cod. 7.01.L  
Bench

Beech

Seat: upholstered.

## Hyppo



Misure (cm) Measurements (cm)	Categoria Category	Struttura Structure	Descrizione Description
	Cod. 9.40.0 Tavolo	Faggio	Piano: laminato.
	Cod. 9.40.0 Table	Beech	Top: laminated.
	Cod. 9.40.J Tavolo	Faggio	Piano: laminato.
	Cod. 9.40.J Table	Beech	Top: laminated.
Hyppo	Cod. C.HY.0 Cuscino		
	Cod. C.HY.0 Cushion		

## Inga



Misure (cm) Measurements (cm)	Categoria Category	Struttura Structure	Descrizione Description
	Cod. 1.01.I Sedia impilabile	Faggio	Sedile: rivestito. Schienale: legno.
	Cod. 1.01.I Stackable chair	Beech	Seat: upholstered. Back: wood.
	Cod. 1.02.I Sedia impilabile	Faggio	Sedile: legno. Schienale: legno.
	Cod. 1.02.I Stackable chair	Beech	Seat: wood. Back: wood.
	Cod. 1.03.I Sedia impilabile	Faggio	Sedile: rivestito. Schienale: legno con pannello rivestito.
	Cod. 1.03.I Stackable chair	Beech	Seat: upholstered. Back: wood with upholstered panel.
	Cod. 1.04.I Sedia impilabile	Faggio	Sedile: legno. Schienale: legno con pannello rivestito.
	Cod. 1.04.I Stackable chair	Beech	Seat: wood. Back: wood with upholstered panel.









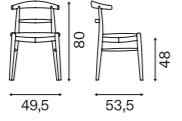

## Inga

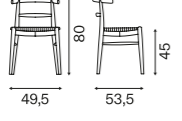

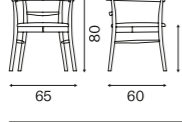

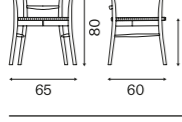

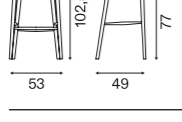





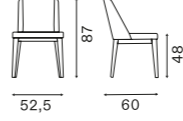

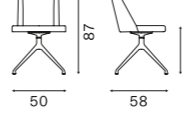
Misure (cm) Measurements (cm)	Categoria Category	Struttura Structure	Descrizione Description
	Cod. 2.01.I Poltrona impilabile	Faggio	Sedile: rivestito. Schienale: legno.
	Cod. 2.01.I Stackable armchair	Beech	Seat: upholstered. Back: wood.
	Cod. 2.02.I Poltrona impilabile	Faggio	Sedile: legno. Schienale: legno.
	Cod. 2.02.I Stackable armchair	Beech	Seat: wood. Back: wood.
	Cod. 2.03.I Poltrona impilabile	Faggio	Sedile: rivestito. Schienale: legno con pannello rivestito.
	Cod. 2.03.I Stackable armchair	Beech	Seat: upholstered. Back: wood with upholstered panel.
	Cod. 2.04.I Poltrona impilabile	Faggio	Sedile: legno. Schienale: legno con pannello rivestito.
	Cod. 2.04.I Stackable armchair	Beech	Seat: wood. Back: wood with upholstered panel.
	Cod. 3.01.0 Sgabello	Faggio	Sedile: rivestito. Schienale: legno.
	Cod. 3.01.0 Stool	Beech	Seat: upholstered. Back: wood.
	Cod. 3.02.0 Sgabello	Faggio	Sedile: legno. Schienale: legno.
	Cod. 3.02.0 Stool	Beech	Seat: wood. Back: wood.
	Cod. 3.03.0 Sgabello	Faggio	Sedile: rivestito. Schienale: legno con pannello rivestito.
	Cod. 3.01.0 Stool	Beech	Seat: upholstered. Back: wood with upholstered panel.
	Cod. 3.04.0 Sgabello	Faggio	Sedile: legno. Schienale: legno con pannello rivestito.
	Cod. 3.04.0 Stool	Beech	Seat: wood. Back: wood with upholstered panel.

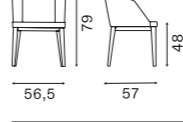

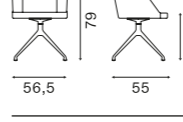

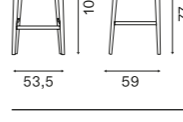
## Karma

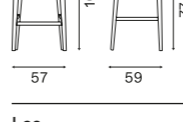
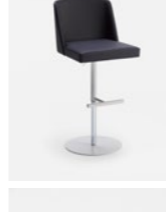
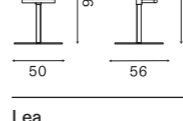
Misure (cm) Measurements (cm)	Categoria Category	Struttura Structure	Descrizione Description
	<b>Karma</b>	Frassino	Sedile: rivestito. Schienale: legno.
	Cod. 1.01.0 Sedia	Ash	Seat: upholstered. Back: wood.
	<b>Karma</b>	Frassino	Sedile: filato di carta. Schienale: legno.
	Cod. 1.12.0 Chair	Ash	Seat: paper cord. Back: wood.
	<b>Karma</b>	Frassino	Sedile: rivestito. Schienale: legno.
	Cod. 2.01.0 Poltrona	Ash	Seat: upholstered. Back: wood.
	<b>Karma</b>	Frassino	Sedile: filato di carta. Schienale: legno.
	Cod. 2.12.0 Poltrona	Ash	Seat: paper cord. Back: wood.
	<b>Karma</b>	Frassino	Sedile: rivestito. Schienale: legno.
	Cod. 3.01.0 Sgabello	Ash	Seat: upholstered. Back: wood.
	<b>Karma</b>	Frassino	Sedile: filato di carta. Schienale: legno.
	Cod. 3.12.0 Sgabello	Ash	Seat: paper cord. Back: wood.

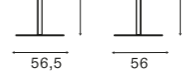

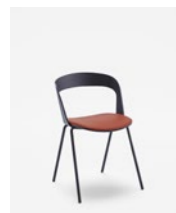
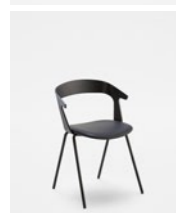
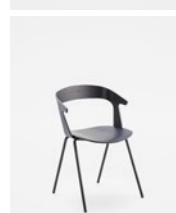
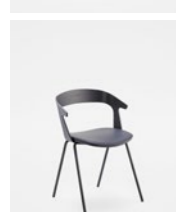
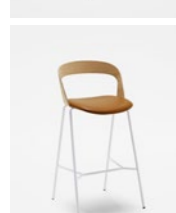
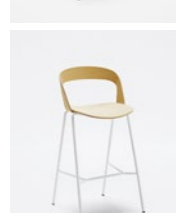
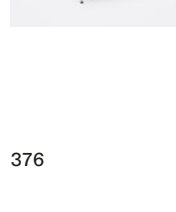

## Lea

Misure (cm) Measurements (cm)	Categoria Category	Struttura Structure	Descrizione Description
	<b>Lea</b>	Faggio	Sedile: rivestito. Schienale: rivestito.
	Cod. 1.03.0 Sedia	Beech	Seat: upholstered. Back: upholstered.
	<b>Lea</b>	Metallo	Sedile: rivestito. Schienale: rivestito. Versione opzionale con ruote.
	Cod. A.03.0 Sedia girevole	Metal	Seat: upholstered. Back: upholstered. Optional: castors.
	<b>Lea</b>	Faggio	Sedile: rivestito. Schienale: rivestito.
	Cod. 2.03.0 Poltrona	Beech	Seat: upholstered. Back: upholstered.
	<b>Lea</b>	Metallo	Sedile: rivestito. Schienale: rivestito. Versione opzionale con ruote.
	Cod. B.03.0 Poltrona girevole	Metal	Seat: upholstered. Back: upholstered. Optional: castors.
	<b>Lea</b>	Faggio	Sedile: rivestito. Schienale: rivestito.
	Cod. 3.03.0 Sgabello	Beech	Seat: upholstered. Back: upholstered.
	<b>Lea</b>	Faggio	Sedile: rivestito. Schienale: rivestito.
	Cod. 3.09.0 Sgabello	Beech	Seat: upholstered. Back: upholstered.
	<b>Lea</b>	Metallo	Sedile: rivestito. Schienale: rivestito.
	Cod. C.03.0/R Sgabello girevole e regolabile	Metal	Seat: upholstered. Back: upholstered.
	<b>Lea</b>	Metallo	Sedile: rivestito. Schienale: rivestito.
	Cod. C.09.0/R Sgabello girevole e regolabile	Metal	Seat: upholstered. Back: upholstered.



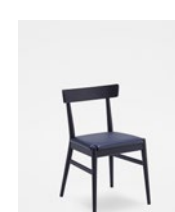
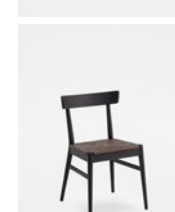
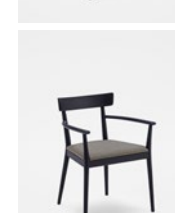

## Maki

Misure (cm) Measurements (cm)	Categoria Category	Struttura Structure	Descrizione Description
 54,5 79 51 48	Cod. 1.01.Z/1 Sedia impilabile	Metallo	Sedile: rivestito. Schienale: legno.
 54,5 79 51 46	Cod. 1.01.Z/1 Stackable chair	Metal	Seat: upholstered. Back: wood.
 57 79 51 48	Cod. 1.02.Z/1 Sedia impilabile	Metallo	Sedile: legno. Schienale: legno.
 57 79 51 48	Cod. 1.02.Z/1 Stackable chair	Metal	Seat: wood. Back: wood.
 57 79 51 48	Cod. 1.23.Z/1 Sedia impilabile	Metallo	Sedile: legno con pannello rivestito. Schienale: legno.
 57 79 51 48	Cod. 1.23.Z/1 Stackable chair	Metal	Seat: wood with upholstered panel. Back: wood.
 57 79 51 46	Cod. 2.01.Z/1 Poltrona impilabile	Metallo	Sedile: rivestito. Schienale: legno.
 57 79 51 46	Cod. 2.01.Z/1 Stackable armchair	Metal	Seat: upholstered. Back: wood.
 57 79 51 48	Cod. 2.02.Z/1 Poltrona impilabile	Metallo	Sedile: legno. Schienale: legno.
 57 79 51 48	Cod. 2.02.Z/1 Stackable armchair	Metal	Seat: wood. Back: wood.
 56 104,5 52 77	Cod. 2.23.Z/1 Poltrona impilabile	Metallo	Sedile: legno con pannello rivestito. Schienale: legno.
 56 104,5 52 77	Cod. 2.23.Z/1 Stackable armchair	Metal	Seat: wood with upholstered panel. Back: wood.
 56 104,5 52 75	Cod. 3.01.Z Sgabello	Metallo	Sedile: rivestito. Schienale: legno.
 56 104,5 52 75	Cod. 3.01.Z Stool	Metal	Seat: upholstered. Back: wood.
 56 104,5 52 75	Cod. 3.02.Z Sgabello	Metallo	Sedile: legno. Schienale: legno.
 56 104,5 52 75	Cod. 3.02.Z Stool	Metal	Seat: wood. Back: wood.

## Maki





Misure (cm) Measurements (cm)	Categoria Category	Struttura Structure	Descrizione Description
 56 104,5 52 77	Cod. 3.23.Z Sgabello	Metallo	Sedile: legno con pannello rivestito. Schienale: legno.
 56 104,5 52 77	Cod. 3.23.Z Stool	Metal	Seat: wood with upholstered panel. Back: wood.
 57 104,5 52 77	Cod. 3.13.Z Sgabello	Metallo	Sedile: rivestito. Schienale: legno.
 57 104,5 52 77	Cod. 3.13.Z Stool	Metal	Seat: upholstered. Back: wood.
 57 104,5 52 75	Cod. 3.14.Z Sgabello	Metallo	Sedile: legno. Schienale: legno.
 57 104,5 52 75	Cod. 3.14.Z Stool	Metal	Seat: wood. Back: wood.
 57 104,5 52 77	Cod. 3.26.Z Sgabello	Metallo	Sedile: legno con pannello rivestito. Schienale: legno.
 57 104,5 52 77	Cod. 3.26.Z Stool	Metal	Seat: wood with upholstered panel. Back: wood.

## Nika



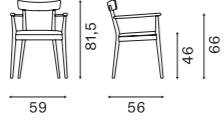

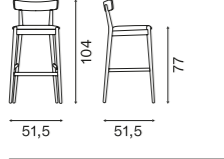

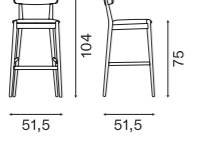
Misure (cm) Measurements (cm)	Categoria Category	Struttura Structure	Descrizione Description
 49 81,5 52 48	Cod. 1.01.0 Sedia	Frassino	Sedile: rivestito. Schienale: legno.
 49 81,5 52 48	Cod. 1.01.0 Chair	Ash	Seat: upholstered. Back: wood.
 49 81,5 52 46	Cod. 1.12.0 Sedia	Frassino	Sedile: filato di carta. Schienale: legno.
 49 81,5 52 46	Cod. 1.12.0 Chair	Ash	Seat: paper cord. Back: wood.
 59 81,5 56 48 66	Cod. 2.01.0 Poltrona	Frassino	Sedile: rivestito. Schienale: legno.
 59 81,5 56 48 66	Cod. 2.01.0 Armchair	Ash	Seat: upholstered. Back: wood.



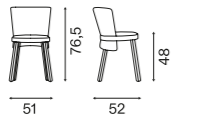

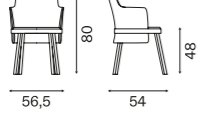
## Nika

Misure (cm) Measurements (cm)	Categoria Category	Struttura Structure	Descrizione Description	
	<b>Nika</b>	Cod. 2.12.0 Poltrona	Frassino	Sedile: filato di carta. Schienale: legno.
	Cod. 2.12.0 Armchair	Ash	Seat: paper cord. Back: wood.	
	<b>Nika</b>	Cod. 3.01.0 Sgabello	Frassino	Sedile: rivestito. Schienale: legno.
	Cod. 3.01.0 Stool	Ash	Seat: upholstered. Back: wood.	
	<b>Nika</b>	Cod. 3.12.0 Sgabello	Frassino	Sedile: filato di carta. Schienale: legno.
	Cod. 3.12.0 Stool	Ash	Seat: paper cord. Back: wood.	

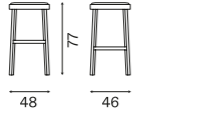





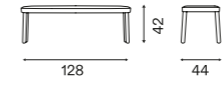

## Obi

Misure (cm) Measurements (cm)	Categoria Category	Struttura Structure	Descrizione Description	
	<b>Obi</b>	Cod. 1.03.0 Sedia	Faggio	Sedile: rivestito. Schienale: rivestito.
	Cod. 1.03.0 Chair	Beech	Seat: upholstered. Back: upholstered.	
	<b>Obi</b>	Cod. 2.03.0 Poltrona	Faggio	Sedile: rivestito. Schienale: rivestito.
	Cod. 2.03.0 Armchair	Beech	Seat: upholstered. Back: upholstered.	
	<b>Obi</b>	Cod. 3.03.0 Sgabello	Faggio	Sedile: rivestito. Schienale: rivestito.
	Cod. 3.03.0 Stool	Beech	Seat: upholstered. Back: upholstered.	
	<b>Obi</b>	Cod. 3.16.A Sgabello	Faggio	Sedile: rivestito.
	Cod. 3.16.A Stool	Beech	Seat: upholstered.	



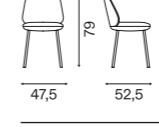

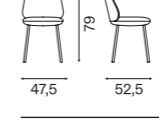

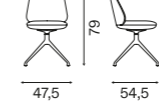



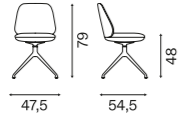

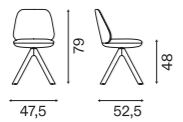

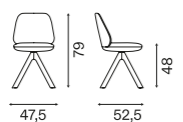

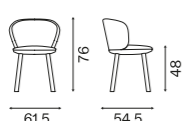
## Obi

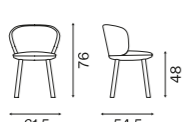
Misure (cm) Measurements (cm)	Categoria Category	Struttura Structure	Descrizione Description	
	<b>Obi</b>	Cod. 3.16.B Sgabello	Faggio	Sedile: rivestito.
	Cod. 3.16.B Stool	Beech	Seat: upholstered.	
	<b>Obi</b>	Cod. 7.01.0 Panca	Faggio	Sedile: rivestito.
	Cod. 7.01.0 Bench	Beech	Seat: upholstered.	

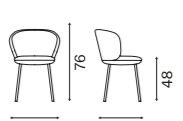



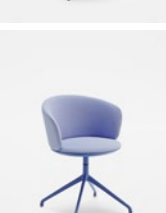





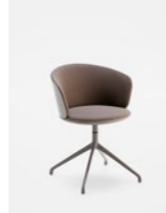
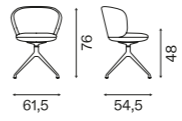
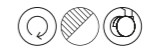
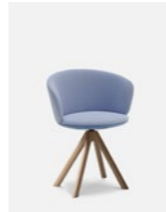

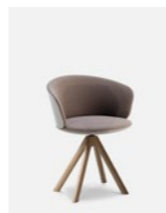
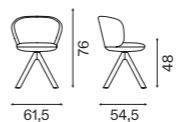

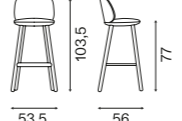
## Palmo

Misure (cm) Measurements (cm)	Categoria Category	Struttura Structure	Descrizione Description	
	<b>Palmo</b>	Cod. 1.03.0 Sedia	Faggio	Sedile: legno con pannello rivestito. Schienale: rivestito.
	Cod. 1.03.0 Chair	Beech	Seat: wood with upholstered panel. Back: upholstered.	
	<b>Palmo</b>	Cod. 1.05.0 Sedia	Faggio	Sedile: legno con pannello rivestito. Schienale: legno rivestito frontalmente.
	Cod. 1.05.0 Chair	Beech	Seat: wood with upholstered panel. Back: wood with upholstered pad.	
	<b>Palmo</b>	Cod. 1.03.Z Sedia	Metallo	Sedile: legno con pannello rivestito. Schienale: rivestito.
	Cod. 1.03.Z Chair	Metal	Seat: wood with upholstered panel. Back: upholstered.	
	<b>Palmo</b>	Cod. 1.05.Z Sedia	Metallo	Sedile: legno con pannello rivestito. Schienale: legno rivestito frontalmente.
	Cod. 1.05.Z Chair	Metal	Seat: wood with upholstered panel. Back: wood with upholstered pad.	
	<b>Palmo</b>	Cod. A.03.0 Sedia girevole	Metallo	Sedile: legno con pannello rivestito. Schienale: rivestito. Versione opzionale con ruote.
	Cod. A.03.0 Swivel chair	Metal	Seat: wood with upholstered panel. Back: upholstered. Optional: castors.	

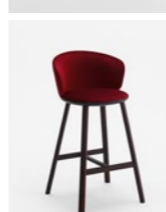
Palmo

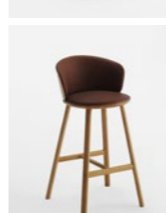

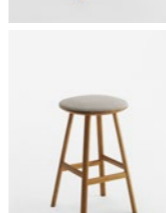







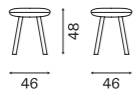

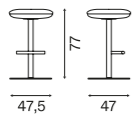
Misure (cm) Measurements (cm)	Categoria Category	Struttura Structure	Descrizione Description
	Palmo Cod. A.05.0 Sedia girevole	Metallo	Sedile: legno con pannello rivestito. Schienale: legno rivestito frontalmente. Versione opzionale con ruote.
	Cod. A.05.0 Swivel chair	Metal	Seat: wood with upholstered panel. Back: wood with upholstered pad. Optional: castors.
			
	Palmo Cod. A.03.0/W Sedia girevole	Faggio	Sedile: legno con pannello rivestito. Schienale: rivestito.
	Cod. A.03.0/W Swivel chair	Beech	Seat: wood with upholstered panel. Back: upholstered.
			
	Palmo Cod. A.05.0/W Sedia girevole	Faggio	Sedile: legno con pannello rivestito. Schienale: legno rivestito frontalmente.
	Cod. A.05.0/W Swivel chair	Beech	Seat: wood with upholstered panel. Back: wood with upholstered pad.
			
	Palmo Cod. 2.03.0 Poltrona	Faggio	Sedile: legno con pannello rivestito. Schienale: rivestito.
	Cod. 2.03.0 Armchair	Beech	Seat: wood with upholstered panel. Back: upholstered.
	Palmo Cod. 2.05.0 Poltrona	Faggio	Sedile: legno con pannello rivestito. Schienale: legno rivestito frontalmente.
	Cod. 2.05.0 Armchair	Beech	Seat: wood with upholstered panel. Back: wood with upholstered pad.
			
	Palmo Cod. 2.03.Z Poltrona	Metallo	Sedile: legno con pannello rivestito. Schienale: rivestito.
	Cod. 2.03.Z Armchair	Metal	Seat: wood with upholstered panel. Back: upholstered.
	Palmo Cod. 2.05.Z Poltrona	Metallo	Sedile: legno con pannello rivestito. Schienale: legno rivestito frontalmente.
	Cod. 2.05.Z Armchair	Metal	Seat: wood with upholstered panel. Back: wood with upholstered pad.
			
	Palmo Cod. B.03.0 Poltrona girevole	Metallo	Sedile: legno con pannello rivestito. Schienale: rivestito. Versione opzionale con ruote.
	Cod. B.03.0 Swivel armchair	Metal	Seat: wood with upholstered panel. Back: upholstered. Optional: castors.
			

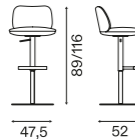
Palmo

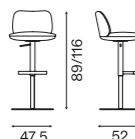

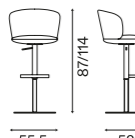

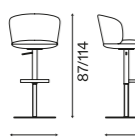

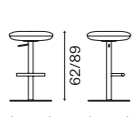
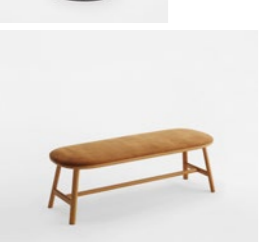
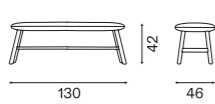

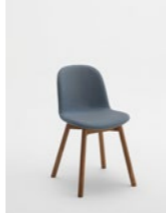
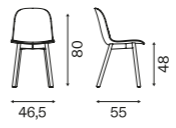

Misure (cm) Measurements (cm)	Categoria Category	Struttura Structure	Descrizione Description
	Palmo Cod. B.05.0 Poltrona girevole	Metallo	Sedile: legno con pannello rivestito. Schienale: legno rivestito frontalmente. Versione opzionale con ruote.
	Cod. B.05.0 Swivel armchair	Metal	Seat: wood with upholstered panel. Back: wood with upholstered pad. Optional: castors.
			
	Palmo Cod. B.03.0/W Poltrona girevole	Faggio	Sedile: legno con pannello rivestito. Schienale: rivestito.
	Cod. B.03.0/W Swivel armchair	Beech	Seat: wood with upholstered panel. Back: upholstered.
			
	Palmo Cod. B.05.0/W Poltrona girevole	Faggio	Sedile: legno con pannello rivestito. Schienale: legno rivestito frontalmente.
	Cod. B.05.0/W Swivel armchair	Beech	Seat: wood with upholstered panel. Back: wood with upholstered pad.
			
	Palmo Cod. 3.03.0 Sgabello	Faggio	Sedile: legno con pannello rivestito. Schienale: rivestito.
	Cod. 3.03.0 Stool	Beech	Seat: wood with upholstered panel. Back: upholstered.
	Palmo Cod. 3.05.0 Sgabello	Faggio	Sedile: legno con pannello rivestito. Schienale: legno rivestito frontalmente.
	Cod. 3.05.0 Stool	Beech	Seat: wood with upholstered panel. Back: wood with upholstered pad.
			
	Palmo Cod. 3.09.0 Sgabello	Faggio	Sedile: legno con pannello rivestito. Schienale: rivestito.
	Cod. 3.09.0 Stool	Beech	Seat: wood with upholstered panel. Back: upholstered.
	Palmo Cod. 3.10.0 Sgabello	Faggio	Sedile: legno con pannello rivestito. Schienale: legno rivestito frontalmente.
	Cod. 3.10.0 Stool	Beech	Seat: wood with upholstered panel. Back: wood with upholstered pad.
			
	Palmo Cod. 3.16.A Sgabello	Faggio	Sedile: legno con pannello rivestito.
	Cod. 3.16.A Stool	Beech	Seat: wood with upholstered panel.

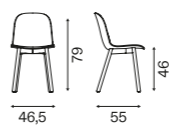
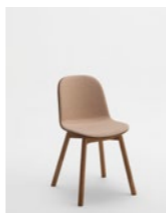
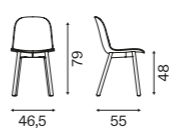
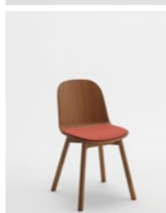
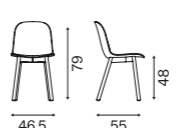
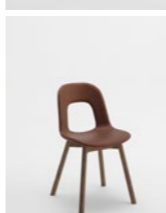

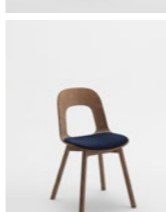

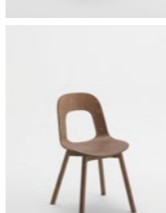

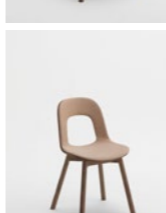







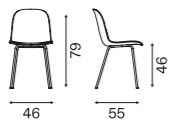

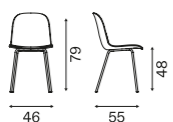
Palmo

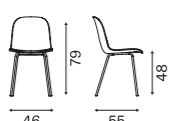
Misure (cm) Measurements (cm)	Categoria Category	Struttura Structure	Descrizione Description
 	Cod. 3.16.B Sgabello	Faggio	Sedile: legno con pannello rivestito.
	Cod. 3.16.B Stool	Beech	Seat: wood with upholstered panel.
 	Cod. 3.16.Z Sgabello	Metallo	Sedile: legno con pannello rivestito.
	Cod. 3.16.Z Stool	Metal	Seat: wood with upholstered panel.
 	Cod. C.03.0/R Sgabello girevole e regolabile	Metallo	Sedile: legno con pannello rivestito. Schienale: rivestito.
	Cod. C.03.0/R Swivel and adjustable stool	Metal	Seat: wood with upholstered panel. Back: upholstered.
 	Cod. C.05.0/R Sgabello girevole e regolabile	Metallo	Sedile: legno con pannello rivestito. Schienale: legno rivestito frontalmente.
	Cod. C.05.0/R Swivel and adjustable stool	Metal	Seat: wood with upholstered panel. Back: wood with upholstered pad.
 	Cod. C.09.0/R Sgabello girevole e regolabile	Metallo	Sedile: legno con pannello rivestito. Schienale: rivestito.
	Cod. C.09.0/R Swivel and adjustable stool	Metal	Seat: wood with upholstered panel. Back: upholstered.
 	Cod. C.10.0/R Sgabello girevole e regolabile	Metallo	Sedile: legno con pannello rivestito. Schienale: legno rivestito frontalmente.
	Cod. C.10.0/R Swivel and adjustable stool	Metal	Seat: wood with upholstered panel. Back: wood with upholstered pad.
 	Cod. C.16.0/R Sgabello girevole e regolabile	Metallo	Sedile: legno con pannello rivestito.
	Cod. C.16.0/R Swivel and adjustable stool	Metal	Seat: wood with upholstered panel.
 	Cod. 7.01.0 Panca	Faggio	Sedile: legno con pannello rivestito.
	Cod. 7.01.0 Bench	Beech	Seat: wood with upholstered panel.





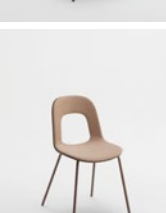

Ribbon

Misure (cm) Measurements (cm)	Categoria Category	Struttura Structure	Descrizione Description
 	Cod. 1.30.0 Sedia	Faggio	Scocca rivestita.
	Cod. 1.30.0 Chair	Beech	Upholstered shell.
 	Cod. 1.31.0 Sedia	Faggio	Scocca legno.
	Cod. 1.31.0 Chair	Beech	Wooden shell.
 	Cod. 1.32.0 Sedia	Faggio	Scocca legno e pannello rivestito.
	Cod. 1.32.0 Chair	Beech	Wooden shell and upholstered panel.
 	Cod. 1.37.0 Sedia	Faggio	Scocca legno e pannello sedile rivestito.
	Cod. 1.37.0 Chair	Beech	Wooden shell and upholstered seat panel.
 	Cod. 1.34.0 Sedia	Faggio	Scocca rivestita.
	Cod. 1.34.0 Chair	Beech	Upholstered shell.
 	Cod. 1.35.0 Sedia	Faggio	Scocca legno e pannello sedile rivestito.
	Cod. 1.35.0 Chair	Beech	Wooden shell and upholstered seat panel.
 	Cod. 1.36.0 Sedia	Faggio	Scocca legno.
	Cod. 1.36.0 Chair	Beech	Wooden shell.
 	Cod. 1.38.0 Sedia	Faggio	Scocca legno e pannello rivestito.
	Cod. 1.38.0 Chair	Beech	Wooden shell and upholstered panel.

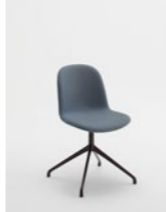
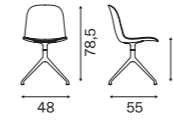
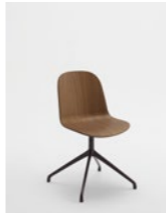
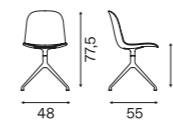
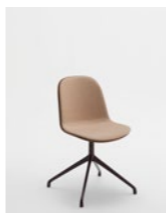
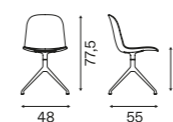
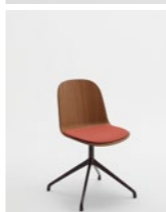
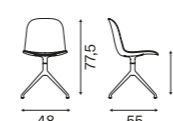
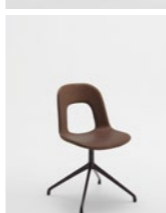
Ribbon

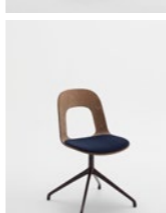
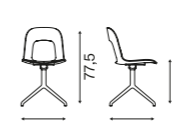
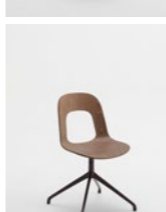
Misure (cm) Measurements (cm)	Categoria Category	Struttura Structure	Descrizione Description
	Ribbon	Cod. 1.30.Z Sedia	Metallo Scocca rivestita.
	Cod. 1.30.Z Chair	Metal	Upholstered shell.
	Ribbon	Cod. 1.31.Z Sedia	Metallo Scocca legno.
	Cod. 1.31.Z Chair	Metal	Wooden shell.
	Ribbon	Cod. 1.32.Z Sedia	Metallo Scocca legno e pannello rivestito.
	Cod. 1.32.Z Chair	Metal	Wooden shell and upholstered panel.
	Ribbon	Cod. 1.37.Z Sedia	Metallo Scocca legno e pannello sedile rivestito.
	Cod. 1.37.Z Chair	Metal	Wooden shell and upholstered seat panel.
	Ribbon	Cod. 1.34.Z Sedia	Metallo Scocca rivestita.
	Cod. 1.34.Z Chair	Metal	Upholstered shell.
	Ribbon	Cod. 1.35.Z Sedia	Metallo Scocca legno e pannello sedile rivestito.
	Cod. 1.35.Z Chair	Metal	Wooden shell and upholstered seat panel.
	Ribbon	Cod. 1.36.Z Sedia	Metallo Scocca legno.
	Cod. 1.36.Z Chair	Metal	Wooden shell.
	Ribbon	Cod. 1.38.Z Sedia	Metallo Scocca legno e pannello rivestito.
	Cod. 1.38.Z Chair	Metal	Wooden shell and upholstered panel.

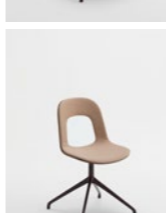
Ribbon

Misure (cm) Measurements (cm)	Categoria Category	Struttura Structure	Descrizione Description
	Ribbon	Cod. A.30.0 Sedia girevole	Metallo Scocca rivestita. Versione opzionale con ruote.
	Cod. A.30.0 Swivel chair	Metal	Upholstered shell. Optional: castors.
	Ribbon	Cod. A.31.0 Sedia girevole	Metallo Scocca legno. Versione opzionale con ruote.
	Cod. A.31.0 Swivel chair	Metal	Wooden shell. Optional: castors.
	Ribbon	Cod. A.32.0 Sedia girevole	Metallo Scocca legno e pannello rivestito. Versione opzionale con ruote.
	Cod. A.32.0 Swivel chair	Metal	Wooden shell and upholstered panel. Optional: castors.
	Ribbon	Cod. A.37.0 Sedia girevole	Metallo Scocca legno e pannello sedile rivestito. Versione opzionale con ruote.
	Cod. A.37.0 Swivel chair	Metal	Wooden shell and upholstered seat panel. Optional: castors.
	Ribbon	Cod. A.34.0 Sedia girevole	Metallo Scocca rivestita. Versione opzionale con ruote.
	Cod. A.34.0 Swivel chair	Metal	Upholstered shell. Optional: castors.
	Ribbon	Cod. A.35.0 Sedia girevole	Metallo Scocca legno e pannello sedile rivestito. Versione opzionale con ruote.
	Cod. A.35.0 Swivel chair	Metal	Wooden shell and upholstered seat panel. Optional: castors.
	Ribbon	Cod. A.36.0 Sedia girevole	Metallo Scocca legno. Versione opzionale con ruote.
	Cod. A.36.0 Swivel chair	Metal	Wooden shell. Optional: castors.
	Ribbon	Cod. A.38.0 Sedia girevole	Metallo Scocca legno e pannello rivestito. Versione opzionale con ruote.
	Cod. A.38.0 Swivel chair	Metal	Wooden shell and upholstered panel. Optional: castors.



Ribbon

Misure (cm) Measurements (cm)	Categoria Category	Struttura Structure	Descrizione Description
	Cod. 2.34.0 Poltrona	Faggio	Scocca legno rivestita.
	Cod. 2.34.0 Armchair	Beech	Upholstered wooden shell.
	Cod. 2.35.0 Poltrona	Faggio	Scocca legno e pannello sedile rivestito.
	Cod. 2.35.0 Armchair	Beech	Wooden shell and upholstered seat panel.
	Cod. 2.36.0 Poltrona	Faggio	Scocca legno.
	Cod. 2.36.0 Armchair	Beech	Wooden shell.
	Cod. 2.38.0 Poltrona	Faggio	Scocca legno e pannello rivestito.
	Cod. 2.38.0 Armchair	Beech	Wooden shell and upholstered panel.
	Cod. 2.34.Z Poltrona	Metallo	Scocca legno rivestita.
	Cod. 2.34.Z Armchair	Metal	Upholstered wooden shell.
	Cod. 2.35.Z Poltrona	Metallo	Scocca legno e pannello sedile rivestito.
	Cod. 2.35.Z Armchair	Metal	Wooden shell and upholstered seat panel.
	Cod. 2.36.Z Poltrona	Metallo	Scocca legno.
	Cod. 2.36.Z Armchair	Metal	Wooden shell.
	Cod. 2.38.Z Poltrona	Metallo	Scocca legno e pannello rivestito.
	Cod. 2.38.Z Armchair	Metal	Wooden shell and upholstered panel.

Ribbon

Misure (cm) Measurements (cm)	Categoria Category	Struttura Structure	Descrizione Description
	Cod. B.34.0 Poltrona girevole	Metallo	Scocca legno rivestita. Versione opzionale con ruote.
	Cod. B.34.0 Swivel armchair	Metal	Upholstered wooden shell. Optional: castors.
	Cod. B.35.0 Poltrona girevole	Metallo	Scocca legno e pannello sedile rivestito. Versione opzionale con ruote.
	Cod. B.35.0 Swivel armchair	Metal	Wooden shell and upholstered seat panel. Optional: castors.
	Cod. B.36.0 Poltrona girevole	Metallo	Scocca legno. Versione opzionale con ruote.
	Cod. B.36.0 Swivel armchair	Metal	Wooden shell. Optional: castors.
	Cod. B.38.0 Poltrona girevole	Metallo	Scocca legno e pannello rivestito. Versione opzionale con ruote.
	Cod. B.38.0 Swivel armchair	Metal	Wooden shell and upholstered panel. Optional: castors.
	Cod. 3.30.0 Sgabello	Faggio	Scocca legno rivestita.
	Cod. 3.30.0 Stool	Beech	Upholstered wooden shell.
	Cod. 3.31.0 Sgabello	Faggio	Scocca legno.
	Cod. 3.31.0 Stool	Beech	Wooden shell.
	Cod. 3.32.0 Sgabello	Faggio	Scocca legno e pannello rivestito.
	Cod. 3.32.0 Stool	Beech	Wooden shell and upholstered panel.
	Cod. 3.37.0 Sgabello	Faggio	Scocca legno e pannello sedile rivestito.
	Cod. 3.37.0 Stool	Beech	Wooden shell and upholstered seat panel.

Ribbon

Misure (cm) Measurements (cm)	Categoria Category	Struttura Structure	Descrizione Description
	Ribbon Cod. 3.34.0 Sgabello	Faggio	Scocca rivestita.
	Cod. 3.34.0 Stool	Beech	Upholstered shell.
	Ribbon Cod. 3.35.0 Sgabello	Faggio	Scocca legno e pannello sedile rivestito.
	Cod. 3.35.0 Stool	Beech	Wooden shell and upholstered seat panel.
	Ribbon Cod. 3.36.0 Sgabello	Faggio	Scocca legno.
	Cod. 3.36.0 Stool	Beech	Wooden shell.
	Ribbon Cod. 3.38.0 Sgabello	Faggio	Scocca legno e pannello rivestito.
	Cod. 3.38.0 Stool	Beech	Wooden shell and upholstered panel.
	Ribbon Cod. 3.30.Z Sgabello	Metallo	Scocca rivestita.
	Cod. 3.30.Z Stool	Metal	Upholstered shell.
	Ribbon Cod. 3.31.Z Sgabello	Metallo	Scocca legno.
	Cod. 3.31.Z Stool	Metal	Wooden shell.
	Ribbon Cod. 3.32.Z Sgabello	Metallo	Scocca legno e pannello rivestito.
	Cod. 3.32.Z Stool	Metal	Wooden shell and upholstered panel.
	Ribbon Cod. 3.37.Z Sgabello	Metallo	Scocca legno e pannello sedile rivestito.
	Cod. 3.37.Z Stool	Metal	Wooden shell and upholstered seat panel.

Ribbon

Misure (cm) Measurements (cm)	Categoria Category	Struttura Structure	Descrizione Description
	Ribbon Cod. 3.34.Z Sgabello	Metallo	Scocca rivestita.
	Cod. 3.34.Z Stool	Metal	Upholstered shell.
	Ribbon Cod. 3.35.Z Sgabello	Metallo	Scocca legno e pannello sedile rivestito.
	Cod. 3.35.Z Stool	Metal	Wooden shell and upholstered seat panel.
	Ribbon Cod. 3.36.Z Sgabello	Metallo	Scocca legno.
	Cod. 3.36.Z Stool	Metal	Wooden shell.
	Ribbon Cod. 3.38.Z Sgabello	Metallo	Scocca legno e pannello rivestito.
	Cod. 3.38.Z Stool	Metal	Wooden shell and upholstered panel.
	Ribbon Cod. C.30.0/R Sgabello girevole e regolabile	Metallo	Scocca rivestita.
	Cod. C.30.0/R Swivel and adjustable stool	Metal	Upholstered shell.
	Ribbon Cod. C.31.0/R Sgabello girevole e regolabile	Metallo	Scocca legno.
	Cod. C.31.0/R Swivel and adjustable stool	Metal	Wooden shell.
	Ribbon Cod. C.32.0/R Sgabello girevole e regolabile	Metallo	Scocca legno e pannello rivestito.
	Cod. C.32.0/R Swivel and adjustable stool	Metal	Wooden shell and upholstered panel.
	Ribbon Cod. C.37.0/R Sgabello girevole e regolabile	Metallo	Scocca legno e pannello sedile rivestito.
	Cod. C.37.0/R Swivel and adjustable stool	Metal	Wooden shell and upholstered seat panel.



## Ribbon

Misure (cm) Measurements (cm)	Categoria Category	Struttura Structure	Descrizione Description
	Cod. C.34.0/R Sgabello girevole e regolabile	Metallo	Scocca rivestita.
	Cod. C.34.0/R Swivel and adjustable stool	Metal	Upholstered shell.
	Cod. C.35.0/R Sgabello girevole e regolabile	Metallo	Scocca legno e pannello sedile rivestito.
	Cod. C.35.0/R Swivel and adjustable stool	Metal	Wooden shell and upholstered seat panel.
	Cod. C.36.0/R Sgabello girevole e regolabile	Metallo	Scocca legno.
	Cod. C.36.0/R Swivel and adjustable stool	Metal	Wooden shell.
	Cod. C.38.0/R Sgabello girevole e regolabile	Metallo	Scocca legno e pannello rivestito.
	Cod. C.38.0/R Swivel and adjustable stool	Metal	Wooden shell and upholstered panel.

## Seeli

Misure (cm) Measurements (cm)	Categoria Category	Struttura Structure	Descrizione Description
	Cod. 1.01.0 Sedia	Faggio	Sedile: rivestito. Schienale: legno.
	Cod. 1.01.0 Chair	Beech	Seat: upholstered. Back: wood.
	Cod. 1.02.0 Sedia	Faggio	Sedile: legno. Schienale: legno.
	Cod. 1.02.0 Chair	Beech	Seat: wood. Back: wood.
	Cod. 1.03.0 Sedia	Faggio	Sedile: rivestito. Schienale: rivestito.
	Cod. 1.03.0 Chair	Beech	Seat: upholstered. Back: upholstered.

## Seeli

Misure (cm) Measurements (cm)	Categoria Category	Struttura Structure	Descrizione Description
	Cod. 1.04.0 Sedia	Faggio	Sedile: legno. Schienale: rivestito.
	Cod. 1.04.0 Chair	Beech	Seat: wood. Back: upholstered.
	Cod. 2.01.0 Poltrona	Faggio	Sedile: rivestito. Schienale: legno.
	Cod. 2.01.0 Armchair	Beech	Seat: upholstered. Back: wood.
	Cod. 2.02.0 Poltrona	Faggio	Sedile: legno. Schienale: legno.
	Cod. 2.02.0 Armchair	Beech	Seat: wood. Back: wood.
	Cod. 2.03.0 Poltrona	Faggio	Sedile: rivestito. Schienale: rivestito.
	Cod. 2.03.0 Armchair	Beech	Seat: upholstered. Back: upholstered.
	Cod. 2.04.0 Poltrona	Faggio	Sedile: legno. Schienale: rivestito.
	Cod. 2.04.0 Armchair	Beech	Seat: wood. Back: upholstered.
	Cod. 3.01.0 Sgabello	Faggio	Sedile: rivestito. Schienale: legno.
	Cod. 3.01.0 Stool	Beech	Seat: upholstered. Back: wood.
	Cod. 3.02.0 Sgabello	Faggio	Sedile: legno. Schienale: legno.
	Cod. 3.02.0 Stool	Beech	Seat: wood. Back: wood.
	Cod. 3.03.0 Sgabello	Faggio	Sedile: rivestito. Schienale: rivestito.
	Cod. 3.03.0 Stool	Beech	Seat: upholstered. Back: upholstered.

## Seeli



Misure (cm) Measurements (cm)	Categoria Category	Struttura Structure	Descrizione Description
	Cod. 3.04.0 Sgabello	Faggio	Sedile: legno. Schienale: rivestito.
	Cod. 3.04.0 Stool	Beech	Seat: wood. Back: upholstered.

## Sprint

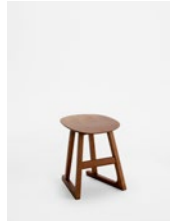

Misure (cm) Measurements (cm)	Categoria Category	Struttura Structure	Descrizione Description
	Cod. 3.17.B Sgabello	Frassino	Sedile: legno.
	Cod. 3.17.B Stool	Ash	Seat: wood.

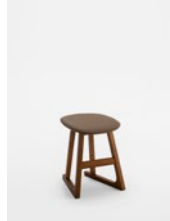

Misure (cm) Measurements (cm)	Categoria Category	Struttura Structure	Descrizione Description
	Cod. 3.18.B Sgabello	Frassino	Sedile: legno con pannello rivestito.
	Cod. 3.18.B Stool	Ash	Seat: wood with upholstered panel.

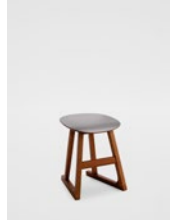

Misure (cm) Measurements (cm)	Categoria Category	Struttura Structure	Descrizione Description
	Cod. 3.19.B Sgabello	Frassino	Sedile: laminato.
	Cod. 3.19.B Stool	Ash	Seat: laminated.



Misure (cm) Measurements (cm)	Categoria Category	Struttura Structure	Descrizione Description
	Cod. 3.17.M Sgabello	Frassino	Sedile: legno.
	Cod. 3.17.M Stool	Ash	Seat: wood.

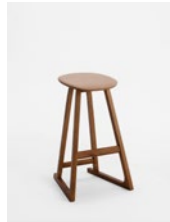

Misure (cm) Measurements (cm)	Categoria Category	Struttura Structure	Descrizione Description
	Cod. 3.18.M Sgabello	Frassino	Sedile: legno con pannello rivestito.
	Cod. 3.18.M Stool	Ash	Seat: wood with upholstered panel.



Misure (cm) Measurements (cm)	Categoria Category	Struttura Structure	Descrizione Description
	Cod. 3.19.M Sgabello	Frassino	Sedile: laminato.
	Cod. 3.19.M Stool	Ash	Seat: laminated.

## Sprint



Misure (cm) Measurements (cm)	Categoria Category	Struttura Structure	Descrizione Description
	Cod. 3.17.A Sgabello	Frassino	Sedile: legno.
	Cod. 3.17.A Stool	Ash	Seat: wood.



Misure (cm) Measurements (cm)	Categoria Category	Struttura Structure	Descrizione Description
	Cod. 3.18.A Sgabello	Frassino	Sedile: legno con pannello rivestito.
	Cod. 3.18.A Stool	Ash	Seat: wood with upholstered panel.



Misure (cm) Measurements (cm)	Categoria Category	Struttura Structure	Descrizione Description
	Cod. 3.19.A Sgabello	Frassino	Sedile: laminato.
	Cod. 3.19.A Stool	Ash	Seat: laminated.

## Stilo



Misure (cm) Measurements (cm)	Categoria Category	Struttura Structure	Descrizione Description
	Cod. A.30.0 Sedia girevole	Metallo	Struttura in faggio rivestita.
	Cod. A.30.0 Swivel chair	Metal	Upholstered frame in beech.



Misure (cm) Measurements (cm)	Categoria Category	Struttura Structure	Descrizione Description
	Cod. B.30.0 Poltrona girevole	Metallo	Struttura in faggio rivestita, braccioli in faggio.
	Cod. B.30.0 Swivel armchair	Metal	Upholstered frame in beech, armrests in beech.



Misure (cm) Measurements (cm)	Categoria Category	Struttura Structure	Descrizione Description
	Cod. E.30.0 Lounge girevole	Metallo	Struttura in faggio rivestita.
	Cod. E.30.0 Swivel lounge chair	Metal	Upholstered frame in beech.



Misure (cm) Measurements (cm)	Categoria Category	Struttura Structure	Descrizione Description
	Cod. G.30.0 Lounge girevole	Metallo	Struttura in faggio rivestita, braccioli in faggio.
	Cod. G.30.0 Swivel lounge chair	Metal	Upholstered frame in beech, armrests in beech.



## Stilo



Misure (cm) Measurements (cm)	Categoria Category	Struttura Structure	Descrizione Description
	Cod. E.30.A Lounge girevole	Metallo	Struttura in faggio rivestita.
	Cod. E.30.A Swivel lounge chair	Metal	Upholstered frame in beech.



	Cod. G.30.A Lounge girevole	Metallo	Struttura in faggio rivestita, braccioli in faggio.
	Cod. G.30.A Swivel lounge chair	Metal	Upholstered frame in beech, armrests in beech.

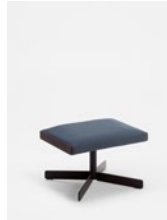

	Cod. 8.01.0 Ottoman	Metallo	Struttura in faggio rivestita.
	Cod. 8.01.0 Ottoman	Metal	Upholstered frame in beech.

## Timber



Misure (cm) Measurements (cm)	Categoria Category	Struttura Structure	Descrizione Description
	Cod. 1.01.1/J Sedia impilabile	Faggio	Sedile: rivestito. Schienale: legno.
	Cod. 1.01.1/J Stackable chair	Beech	Seat: upholstered. Back: wood.



	Cod. 1.02.1/J Sedia impilabile	Faggio	Sedile: legno. Schienale: legno.
	Cod. 1.02.1/J Stackable chair	Beech	Seat: wood. Back: wood.



	Cod. 1.03.1/J Sedia impilabile	Faggio	Sedile: rivestito. Schienale: legno con pannello rivestito.
	Cod. 1.03.1/J Stackable chair	Beech	Seat: upholstered. Back: wood with upholstered panel.

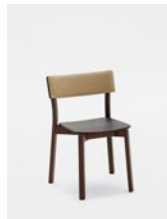

	Cod. 1.04.1/J Sedia impilabile	Faggio	Sedile: legno. Schienale: legno con pannello rivestito.
	Cod. 1.04.1/J Stackable chair	Beech	Seat: wood. Back: wood with upholstered panel.

## Timber



Misure (cm) Measurements (cm)	Categoria Category	Struttura Structure	Descrizione Description
	Cod. 1.01.1/K Sedia impilabile	Faggio	Sedile: rivestito. Schienale: legno.
	Cod. 1.01.1/K Stackable chair	Beech	Seat: upholstered. Back: wood.



	Cod. 1.02.1/K Sedia impilabile	Faggio	Sedile: legno. Schienale: legno.
	Cod. 1.02.1/K Stackable chair	Beech	Seat: wood. Back: wood.



	Cod. 1.03.1/W Sedia impilabile	Faggio	Sedile: rivestito. Schienale: rivestito.
	Cod. 1.03.1/W Stackable chair	Beech	Seat: upholstered. Back: upholstered.



	Cod. 1.01.1/X Sedia impilabile	Faggio	Sedile: rivestito. Schienale: legno.
	Cod. 1.01.1/X Stackable chair	Beech	Seat: upholstered. Back: wood.



	Cod. 1.02.1/X Sedia impilabile	Faggio	Sedile: legno. Schienale: legno.
	Cod. 1.02.1/X Stackable chair	Beech	Seat: wood. Back: wood.



	Cod. 2.01.0/J Poltrona	Faggio	Sedile: rivestito. Schienale: legno.
	Cod. 2.01.0/J Armchair	Beech	Seat: upholstered. Back: wood.











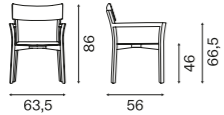

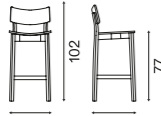

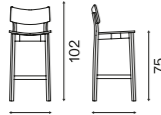

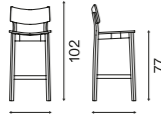

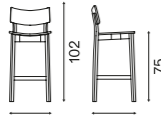
	Cod. 2.02.0/J Poltrona	Faggio	Sedile: legno. Schienale: legno.
	Cod. 2.02.0/J Armchair	Beech	Seat: wood. Back: wood.

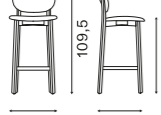

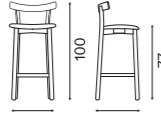

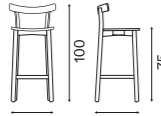
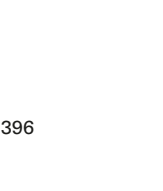



	Cod. 2.03.0/J Poltrona	Faggio	Sedile: rivestito. Schienale: legno con pannello rivestito.
	Cod. 2.03.0/J Armchair	Beech	Seat: upholstered. Back: wood with upholstered panel.

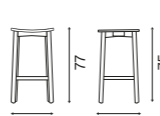

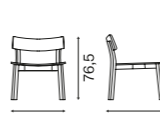

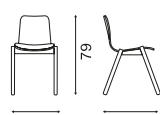
## Timber

Misure (cm) Measurements (cm)	Categoria Category	Struttura Structure	Descrizione Description
 	Cod. 2.04.0/J Poltrona	Faggio	Sedile: legno. Schienale: legno con pannello rivestito.
 	Cod. 2.04.0/J Armchair	Beech	Seat: wood. Back: wood with upholstered panel.
 	Cod. 3.01.0/J Sgabello	Faggio	Sedile: rivestito. Schienale: legno.
 	Cod. 3.01.0/J Stool	Beech	Seat: upholstered. Back: wood.
 	Cod. 3.02.0/J Sgabello	Faggio	Sedile: legno. Schienale: legno.
 	Cod. 3.02.0/J Stool	Beech	Seat: wood. Back: wood.
 	Cod. 3.03.0/J Sgabello	Faggio	Sedile: rivestito. Schienale: legno con pannello rivestito.
 	Cod. 3.03.0/J Stool	Beech	Seat: upholstered. Back: wood with upholstered panel.
 	Cod. 3.04.0/J Sgabello	Faggio	Sedile: legno. Schienale: legno con pannello rivestito.
 	Cod. 3.04.0/J Stool	Beech	Seat: wood. Back: wood with upholstered panel.
 	Cod. 3.03.0/W Sgabello	Faggio	Sedile: rivestito. Schienale: rivestito.
 	Cod. 3.03.0/W Stool	Beech	Seat: upholstered. Back: upholstered.
 	Cod. 3.01.0/X Sgabello	Faggio	Sedile: rivestito. Schienale: legno.
 	Cod. 3.01.0/X Stool	Beech	Seat: upholstered. Back: wood.
 	Cod. 3.02.0/X Sgabello	Faggio	Sedile: legno. Schienale: legno.
 	Cod. 3.02.0/X Stool	Beech	Seat: wood. Back: wood.

## Timber

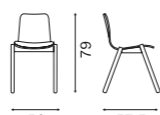
Misure (cm) Measurements (cm)	Categoria Category	Struttura Structure	Descrizione Description
 	Cod. 3.16.A/J Sgabello	Faggio	Sedile: rivestito.
 	Cod. 3.16.A/J Stool	Beech	Seat: upholstered.
 	Cod. 3.17.A/J Sgabello	Faggio	Sedile: legno.
 	Cod. 3.17.A/J Stool	Beech	Seat: wood.
 	Cod. 3.16.B/J Sgabello	Faggio	Sedile: rivestito.
 	Cod. 3.16.B/J Stool	Beech	Seat: upholstered.
 	Cod. 3.17.B/J Sgabello	Faggio	Sedile: legno.
 	Cod. 3.17.B/J Stool	Beech	Seat: wood.
 	Cod. 5.03.0/J Lounge	Faggio	Sedile: rivestito. Schienale: legno con pannello rivestito.
 	Cod. 5.03.0/J Lounge chair	Beech	Seat: upholstered. Back: wood with upholstered panel.

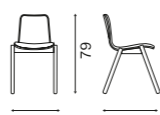
## Tipi







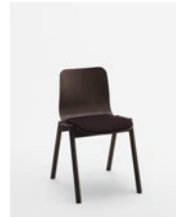
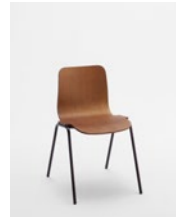
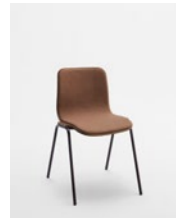
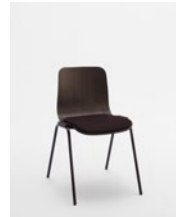
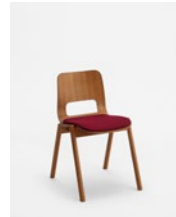
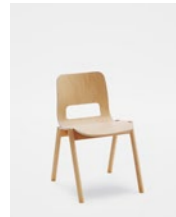
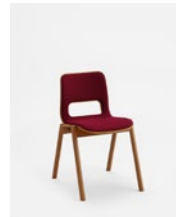
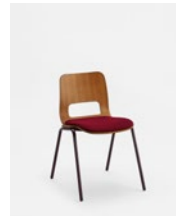

Misure (cm) Measurements (cm)	Categoria Category	Struttura Structure	Descrizione Description
 	Cod. 1.31.1 Sedia impilabile	Faggio	Scocca legno.
 	Cod. 1.31.1 Stackable chair	Beech	Wooden shell.
 	Cod. 1.32.1 Sedia impilabile	Faggio	Scocca legno e pannello rivestito.
 	Cod. 1.32.1 Stackable chair	Beech	Wooden shell and upholstered panel.









Tipi

Misure (cm) Measurements (cm)	Categoria Category	Struttura Structure	Descrizione Description
 50 79 57,5 48	Cod. 1.37.I Sedia impilabile Stackable chair	Faggio Beech	Scocca legno e pannello sedile rivestito. Wooden shell and upholstered seat panel.
 54 79 57,5 46	Cod. 1.31.Z-I Sedia impilabile Stackable chair	Metallo Metal	Scocca legno. Wooden shell.
 54 79 57,5 48	Cod. 1.32.Z-I Sedia impilabile Stackable chair	Metallo Metal	Scocca legno e pannello rivestito. Wooden shell and upholstered panel.
 54 79 57,5 48	Cod. 1.37.Z-I Sedia impilabile Stackable chair	Metallo Metal	Scocca legno e pannello rivestito. Wooden shell and upholstered panel.
 50 79 57,5 48	Cod. 1.35.I Sedia impilabile Stackable chair	Faggio Beech	Scocca legno e pannello sedile rivestito. Wooden shell and upholstered seat panel.
 50 79 57,5 46	Cod. 1.36.I Sedia impilabile Stackable chair	Faggio Beech	Scocca legno. Wooden shell.
 50 79 57,5 48	Cod. 1.38.I Sedia impilabile Stackable chair	Faggio Beech	Scocca legno e pannello rivestito. Wooden shell and upholstered panel.
 54 79 57,5 48	Cod. 1.35.Z-I Sedia impilabile Stackable chair	Metallo Metal	Scocca legno e pannello sedile rivestito. Wooden shell and upholstered seat panel.





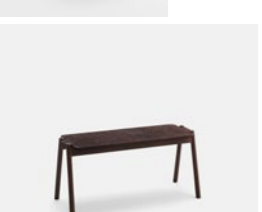
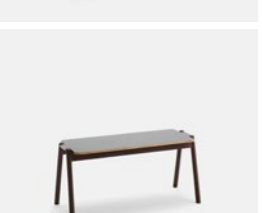

Tipi

Misure (cm) Measurements (cm)	Categoria Category	Struttura Structure	Descrizione Description
 54 79 57,5 46	Cod. 1.36.Z-I Sedia impilabile Stackable chair	Metallo Metal	Scocca legno. Wooden shell.
 54 79 57,5 48	Cod. 1.38.Z-I Sedia impilabile Stackable chair	Metallo Metal	Scocca legno e pannello rivestito. Wooden shell and upholstered panel.
 50 99 58,5 75	Cod. 3.31.0 Sgabello Stool	Faggio Beech	Scocca legno. Wooden shell.
 50 99 58,5 77	Cod. 3.32.0 Sgabello Stool	Faggio Beech	Scocca legno e pannello rivestito. Wooden shell and upholstered panel.
 50 99 58,5 77	Cod. 3.37.0 Sgabello Stool	Faggio Beech	Scocca legno e pannello sedile rivestito. Wooden shell and upholstered seat panel.
 50 99 59 75	Cod. 3.31.Z Sgabello Stool	Metallo Metal	Scocca legno. Wooden shell.
 50 99 59 77	Cod. 3.32.Z Sgabello Stool	Metallo Metal	Scocca legno e pannello rivestito. Wooden shell and upholstered panel.
 50 99 59 77	Cod. 3.37.Z Sgabello Stool	Metallo Metal	Scocca legno e pannello sedile rivestito. Wooden shell and upholstered seat panel.

Tipi





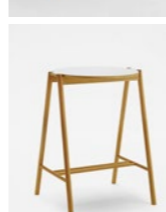
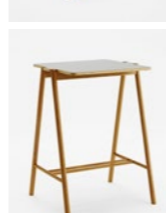



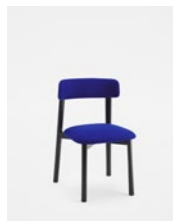
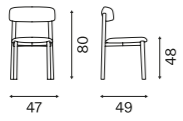
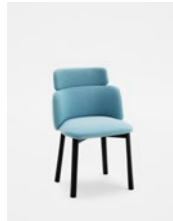
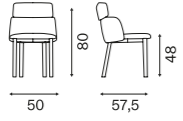
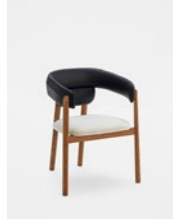
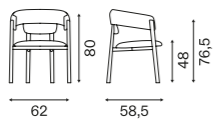

Misure (cm) Measurements (cm)	Categoria Category	Struttura Structure	Descrizione Description
 46,5 75 48,5	Cod. 3.17.A Sgabello	Faggio	Sedile: legno.
	Cod. 3.17.A Stool	Beech	Seat: wood.
 46,5 77 48,5	Cod. 3.18.A Sgabello	Faggio	Sedile: legno con pannello rivestito.
	Cod. 3.18.A Stool	Beech	Seat: wood with upholstered panel.
 46 46 42	Cod. 3.17.B/1 Sgabello impilabile	Faggio	Sedile: legno.
	Cod. 3.17.B/1 Stackable stool	Beech	Seat: wood.
 46 47,5 42	Cod. 3.18.B/1 Sgabello impilabile	Faggio	Sedile: legno con pannello rivestito.
	Cod. 3.18.B/1 Stackable stool	Beech	Seat: wood with upholstered panel.
 46 46 42 Ø39	Cod. 3.19.B/1.T Sgabello impilabile	Faggio	Sedile: laminato.
	Cod. 3.19.B/1.T Stackable stool	Beech	Seat: laminate.
 46 46 40 46 39	Cod. 3.19.B/1.Q Sgabello impilabile	Faggio	Sedile: laminato.
	Cod. 3.19.B/1.Q Stackable stool	Beech	Seat: laminate.
 100 46 40	Cod. 7.02.2/1 Panca impilabile	Faggio	Sedile: legno.
	Cod. 7.02.2/1 Stackable bench	Beech	Seat: wood.
 100 46 40	Cod. 7.07.2/1 Panca impilabile	Faggio	Sedile: laminato.
	Cod. 7.07.2/1 Stackable bench	Beech	Seat: laminate.

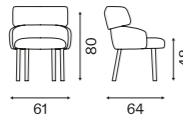
Tipi

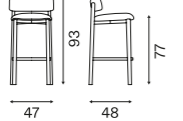

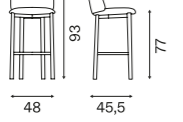

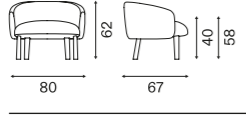

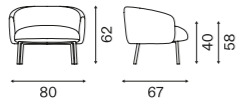
Misure (cm) Measurements (cm)	Categoria Category	Struttura Structure	Descrizione Description
 100 47,5 40	Cod. 7.23.2/1 Panca impilabile	Faggio	Sedile: legno con pannello rivestito.
	Cod. 7.23.2/1 Stackable bench	Beech	Seat: wood with upholstered panel.
 140 46 40	Cod. 7.02.3/1 Panca impilabile	Faggio	Sedile: legno.
	Cod. 7.02.3/1 Stackable bench	Beech	Seat: wood.
 140 46 40	Cod. 7.07.3/1 Panca impilabile	Faggio	Sedile: laminato.
	Cod. 7.07.3/1 Stackable bench	Beech	Seat: laminate.
 140 47,5 40	Cod. 7.23.3/1 Panca impilabile	Faggio	Sedile: legno con pannello rivestito.
	Cod. 7.23.3/1 Stackable bench	Beech	Seat: wood with upholstered panel.
 78 75 70 Ø70	Cod. 9.40.A/1.T Tavolo impilabile	Faggio	Piano: laminato.
	Cod. 9.40.A/1.T Stackable table	Beech	Top: laminate.
 78 75 70	Cod. 9.40.A/1.Q Tavolo impilabile	Faggio	Piano: laminato.
	Cod. 9.40.A/1.Q Stackable table	Beech	Top: laminate.
 78 110 70 Ø70	Cod. 9.40.HT Tavolo	Faggio	Piano: laminato.
	Cod. 9.40.HT Table	Beech	Top: laminate.
 78 110 78	Cod. 9.40.HQ Tavolo	Faggio	Piano: laminato.
	Cod. 9.40.HQ Table	Beech	Top: laminate.

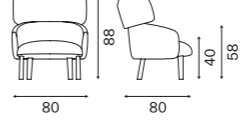

## Tuilli

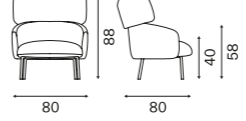
Misure (cm) Measurements (cm)	Categoria Category	Struttura Structure	Descrizione Description
	Cod. 1.03.0/X Sedia	Frassino	Sedile: rivestito. Schienale: rivestito.
	Cod. 1.03.0/X Chair	Ash	Seat: upholstered. Back: upholstered.
	Cod. 1.03.0/W Sedia	Frassino	Sedile: rivestito. Schienale: rivestito.
	Cod. 1.03.0/W Chair	Ash	Seat: upholstered. Back: upholstered.
	Cod. 2.03.0/X Poltrona	Frassino	Sedile: rivestito. Schienale: rivestito.
	Cod. 2.03.0/X Armchair	Ash	Seat: upholstered. Back: upholstered.
	Cod. 2.03.0/W Poltrona	Frassino	Sedile: rivestito. Schienale: rivestito.
	Cod. 2.03.0/W Armchair	Ash	Seat: upholstered. Back: upholstered.
	Cod. 3.03.0/X Sgabello	Frassino	Sedile: rivestito. Schienale: rivestito.
	Cod. 3.03.0/X Stool	Ash	Seat: upholstered. Back: upholstered.
	Cod. 3.03.0/W Sgabello	Frassino	Sedile: rivestito. Schienale: rivestito.
	Cod. 3.03.0/W Stool	Ash	Seat: upholstered. Back: upholstered.
	Cod. 5.03.0 Lounge	Frassino	Sedile: rivestito. Schienale: rivestito.
	Cod. 5.03.0 Lounge chair	Ash	Seat: upholstered. Back: upholstered.
	Cod. 5.03.Z Lounge	Metallo	Sedile: rivestito. Schienale: rivestito.
	Cod. 5.03.Z Lounge chair	Metal	Seat: upholstered. Back: upholstered.

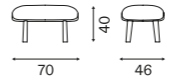

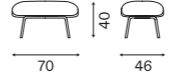







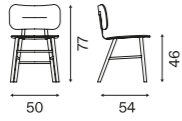

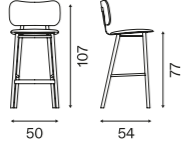

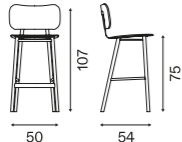
## Tuilli

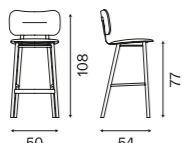
Misure (cm) Measurements (cm)	Categoria Category	Struttura Structure	Descrizione Description
	Cod. 5.09.0 Lounge	Frassino	Sedile: rivestito. Schienale: rivestito.
	Cod. 5.09.0 Lounge chair	Ash	Seat: upholstered. Back: upholstered.
	Cod. 5.09.Z Lounge	Metallo	Sedile: rivestito. Schienale: rivestito.
	Cod. 5.09.Z Lounge chair	Metal	Seat: upholstered. Back: upholstered.
	Cod. 8.01.0 Ottoman	Frassino	Sedile: rivestito.
	Cod. 8.01.0 Ottoman	Ash	Seat: upholstered.
	Cod. 8.01.Z Ottoman	Metallo	Sedile: rivestito.
	Cod. 8.01.Z Ottoman	Metal	Seat: upholstered.

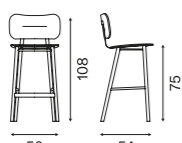

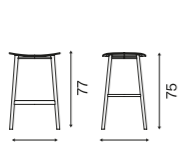

## Viki

Misure (cm) Measurements (cm)	Categoria Category	Struttura Structure	Descrizione Description
	Cod. 1.01.0 Sedia	Faggio	Sedile: rivestito. Schienale: legno.
	Cod. 1.01.0 Chair	Beech	Seat: upholstered. Back: wood.
	Cod. 1.02.0 Sedia	Faggio	Sedile: legno. Schienale: legno.
	Cod. 1.02.0 Chair	Beech	Seat: wood. Back: wood.
	Cod. 1.03.0 Sedia	Faggio	Sedile: rivestito. Schienale: rivestito.
	Cod. 1.03.0 Chair	Beech	Seat: upholstered. Back: upholstered.



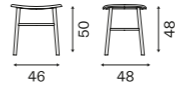

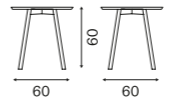

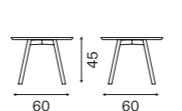
Viki

Misure (cm) Measurements (cm)	Categoria Category	Struttura Structure	Descrizione Description
	Cod. 1.04.0 Sedia	Faggio	Sedile: legno. Schienale: rivestito.
	Cod. 1.04.0 Chair	Beech	Seat: wood. Back: upholstered.
	Cod. 3.01.0 Sgabello	Faggio	Sedile: rivestito. Schienale: legno.
	Cod. 3.01.0 Stool	Beech	Seat: upholstered. Back: wood.
	Cod. 3.02.0 Sgabello	Faggio	Sedile: legno. Schienale: legno.
	Cod. 3.02.0 Stool	Beech	Seat: wood. Back: wood.
	Cod. 3.03.0 Sgabello	Faggio	Sedile: rivestito. Schienale: rivestito.
	Cod. 3.03.0 Stool	Beech	Seat: upholstered. Back: upholstered.
	Cod. 3.04.0 Sgabello	Faggio	Sedile: legno. Schienale: rivestito.
	Cod. 3.04.0 Stool	Beech	Seat: wood. Back: upholstered.
	Cod. 3.17.A Sgabello	Faggio	Sedile: legno.
	Cod. 3.17.A Stool	Beech	Seat: wood.
	Cod. 3.16.A Sgabello	Faggio	Sedile: rivestito.
	Cod. 3.16.A Stool	Beech	Seat: upholstered.
	Cod. 3.17.B Sgabello	Faggio	Sedile: legno.
	Cod. 3.17.B Stool	Beech	Seat: wood.

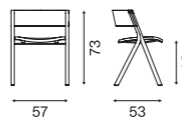
Viki

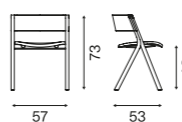
Misure (cm) Measurements (cm)	Categoria Category	Struttura Structure	Descrizione Description
	Cod. 3.16.B Sgabello	Faggio	Sedile: rivestito.
	Cod. 3.16.B Stool	Beech	Seat: upholstered.
	Cod. 9.40.A Tavolo	Faggio	Piano: laminato.
	Cod. 9.40.A Table	Beech	Top: laminate.
	Cod. 9.40.B Tavolo	Faggio	Piano: laminato.
	Cod. 9.40.B Table	Beech	Top: laminate.

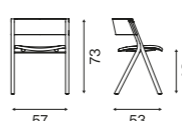
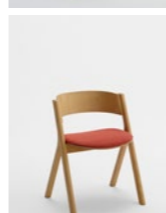
Why

Misure (cm) Measurements (cm)	Categoria Category	Struttura Structure	Descrizione Description
	Cod. 1.02.0 Sedia	Frassino	Sedile: legno. Schienale: legno.
	Cod. 1.02.0 Chair	Ash	Seat: wood. Back: wood.
	Cod. 1.04.0 Sedia	Frassino	Sedile: legno. Schienale: legno con pannello rivestito.
	Cod. 1.04.0 Chair	Ash	Seat: wood. Back: wood with upholstered panel.
	Cod. 1.07.0 Sedia	Frassino	Sedile: laminato. Schienale: legno.
	Cod. 1.07.0 Chair	Ash	Seat: laminate. Back: wood.
	Cod. 1.23.0 Sedia	Frassino	Sedile: legno con pannello rivestito. Schienale: legno.
	Cod. 1.23.0 Chair	Ash	Seat: wood with upholstered panel. Back: wood.



## Why



Misure (cm) Measurements (cm)	Categoria Category	Struttura Structure	Descrizione Description
	Cod. 1.24.0 Sedia	Frassino	Sedile: legno con pannello rivestito. Schienale: legno con pannello rivestito.
	Cod. 1.24.0 Chair	Ash	Seat: wood with upholstered panel. Back: wood with upholstered panel.
	Cod. 3.02.0 Sgabello	Frassino	Sedile: legno. Schienale: legno.
	Cod. 3.02.0 Stool	Ash	Seat: wood. Back: wood.
	Cod. 3.04.0 Sgabello	Frassino	Sedile: legno. Schienale: legno con pannello rivestito.
	Cod. 3.04.0 Stool	Ash	Seat: wood. Back: wood with upholstered panel.
	Cod. 3.07.0 Sgabello	Frassino	Sedile: laminato. Schienale: legno.
	Cod. 3.07.0 Stool	Ash	Seat: laminate. Back: wood.
	Cod. 3.23.0 Sgabello	Frassino	Sedile: legno con pannello rivestito. Schienale: legno.
	Cod. 3.23.0 Stool	Ash	Seat: wood with upholstered panel. Back: wood.
	Cod. 3.24.0 Sgabello	Frassino	Sedile: legno con pannello rivestito. Schienale: legno con pannello rivestito.
	Cod. 3.24.0 Stool	Ash	Seat: wood with upholstered panel. Back: wood with upholstered panel.

## Yumi



Misure (cm) Measurements (cm)	Categoria Category	Struttura Structure	Descrizione Description
	Cod. 1.01.1 Sedia impilabile	Faggio	Sedile: rivestito. Schienale: legno.
	Cod. 1.01.1 Stackable chair	Beech	Seat: upholstered. Back: wood.
	Cod. 1.02.1 Sedia impilabile	Faggio	Sedile: legno. Schienale: legno.
	Cod. 1.02.1 Stackable chair	Beech	Seat: wood. Back: wood.
	Cod. 1.03.1 Sedia impilabile	Faggio	Sedile: rivestito. Schienale: rivestito.
	Cod. 1.03.1 Stackable chair	Beech	Seat: upholstered. Back: upholstered.
	Cod. 1.04.1 Sedia impilabile	Faggio	Sedile: legno. Schienale: rivestito.
	Cod. 1.04.1 Stackable chair	Beech	Seat: wood. Back: upholstered.
	Cod. 1.07.1 Sedia impilabile	Faggio	Sedile: laminato. Schienale: legno.
	Cod. 1.07.1 Stackable chair	Beech	Seat: laminate. Back: wood.
	Cod. 2.01.0 Poltrona	Faggio	Sedile: rivestito. Schienale: legno.
	Cod. 2.01.0 Armchair	Beech	Seat: upholstered. Back: wood.
	Cod. 2.02.0 Poltrona	Faggio	Sedile: legno. Schienale: legno.
	Cod. 2.02.0 Armchair	Beech	Seat: wood. Back: wood.
	Cod. 2.03.0 Poltrona	Faggio	Sedile: rivestito. Schienale: rivestito.
	Cod. 2.03.0 Armchair	Beech	Seat: upholstered. Back: upholstered.

Yumi



Misure (cm) Measurements (cm)	Categoria Category	Struttura Structure	Descrizione Description
	Cod. 2.04.0 Poltrona	Faggio	Sedile: legno. Schienale: rivestito.
	Cod. 2.04.0 Armchair	Beech	Seat: wood. Back: upholstered.
	Cod. 2.07.0 Poltrona	Faggio	Sedile: laminato. Schienale: legno.
	Cod. 2.07.0 Armchair	Beech	Seat: laminate. Back: wood.
	Cod. 3.01.0 Sgabello	Faggio	Sedile: rivestito. Schienale: legno.
	Cod. 3.01.0 Stool	Beech	Seat: upholstered. Back: wood.
	Cod. 3.02.0 Sgabello	Faggio	Sedile: legno. Schienale: legno.
	Cod. 3.02.0 Stool	Beech	Seat: wood. Back: wood.
	Cod. 3.03.0 Sgabello	Faggio	Sedile: rivestito. Schienale: rivestito.
	Cod. 3.03.0 Stool	Beech	Seat: upholstered. Back: upholstered.
	Cod. 3.04.0 Sgabello	Faggio	Sedile: legno. Schienale: rivestito.
	Cod. 3.04.0 Stool	Beech	Seat: wood. Back: upholstered.
	Cod. 3.07.0 Sgabello	Faggio	Sedile: laminato. Schienale: legno.
	Cod. 3.07.0 Stool	Beech	Seat: laminate. Back: wood.
	Cod. 3.09.0 Sgabello	Faggio	Sedile: rivestito. Schienale: rivestito.
	Cod. 3.09.0 Stool	Beech	Seat: upholstered. Back: upholstered.

Yumi



Misure (cm) Measurements (cm)	Categoria Category	Struttura Structure	Descrizione Description
	Cod. 3.13.0 Sgabello	Faggio	Sedile: rivestito. Schienale: legno.
	Cod. 3.13.0 Stool	Beech	Seat: upholstered. Back: wood.
	Cod. 3.14.0 Sgabello	Faggio	Sedile: legno. Schienale: legno.
	Cod. 3.14.0 Stool	Beech	Seat: wood. Back: wood.
	Cod. 3.15.0 Sgabello	Faggio	Sedile: laminato. Schienale: legno.
	Cod. 3.15.0 Stool	Beech	Seat: laminate. Back: wood.
	Cod. 3.28.0 Sgabello	Faggio	Sedile: legno. Schienale: rivestito.
	Cod. 3.28.0 Stool	Beech	Seat: wood. Back: upholstered.





<b>Tinte</b> Stained wood	415 Faggio Frassino Beech Ash
<b>Aniline</b> Anilines	415 Faggio Frassino Beech Ash
<b>Laccati</b> Lacquered	416 Faggio Frassino Beech Ash
<b>Laminati</b> Laminates	416 Colori Colors
<b>Metalli</b> Metals	416 Colori Colors
<b>Filo di carta</b> Paper cord	416 Colori Colors
<b>Tessuti</b> Fabrics	Cat. A 418 Angel 418 Era 418 Surround
	Cat. B 418 Extrema AU 419 MLF 419 One Sirtori Tundra
	Cat. C 419 Blazer 419 One Sirtori Lario 420 One Sirtori Orsetto 420 Polo
	Cat. D 420 Canvas 420 Remix 3 421 Steelcut Trio 3 421 Elmosoft 421 Tivano
<b>Tessuti ECO</b> Fabrics ECO	Cat. B 422 Eve
	Cat. C 422 Reflect 422 Teraskin Nappa
<b>Tessuti OUTDOOR</b> Fabrics OUTDOOR	Cat. A 423 Vortice 423 Yacht Regatta
	Cat. B 423 Clouds Openair 423 Clouds Setting

## VERNICI

Nella filosofia produttiva di Cantarutti le prerogative ambientali sono un obiettivo primario e irrinunciabile, come dimostrano le certificazioni collegate alla sostenibilità del prodotto, all'organizzazione aziendale e ai processi produttivi già ottenute. Il nostro costante impegno a ricercare la qualità nel rispetto dell'ambiente e della salute ci ha portato a muovere un ulteriore importante passo in questo senso con l'adozione di una nuova generazione di vernici sostenibili da utilizzare per le finiture dei nostri prodotti. Ecologiche perché sviluppate con materie prime da fonti rinnovabili di origine vegetale di scarto, non destinate alla nutrizione dell'Uomo. Si tratta della prima linea di vernici per legno poliuretatiche Bio che permette di ottenere una finitura con più del 50% di parte rinnovabile. Questo valore è stato misurato attraverso il test di datazione del Carbonio-14 e certificato da BETA ANALYTICS. La scelta green di Cantarutti nell'utilizzo di vernici Bio contribuisce a ricercare uno stile di design e di vita consapevole e sostenibile, senza rinunciare alla massima qualità e performance di resistenza a:

- liquidi caldi e freddi (UNI EN 12720)
- graffi ed incisioni (UNI EN 151869 e 10782)
- sbalzi di temperatura (UNI 9429)
- ingiallimento (UNI EN 15187)

Grazie alle loro composizioni, le vernici utilizzate rispettando anche la normativa EN 71-3:2013 che certifica la sicurezza dei giocattoli. Oltre all'ergonomia e al gusto estetico, per i quali l'azienda si avvale della collaborazione di alcuni tra i più talentuosi designer, per Cantarutti la sostenibilità ed il rispetto per l'ambiente sono valori altrettanto fondamentali su cui basare la realizzazione delle proprie collezioni, con l'impegno quotidiano rivolto a produrre in modo responsabile e consapevole.

## STAINS

In Cantarutti's production philosophy environmental prerogatives are a primary and indispensable objective, as evidenced by the certifications linked to product sustainability, company organization and production processes already obtained. Our constant commitment to seeking quality while respecting the environment and health has led us to take another important step in this direction, with the adoption of a new generation of sustainable stains to be used for the finishes of our products. Ecological because they are developed with raw materials from renewable sources of waste plant origin, not intended for human nutrition. This is the first line of Bio polyurethane stains for wood that achieves a finish with more than 50% renewables. This value was measured through the Carbon-14 dating test and certified by BETA ANALYTICS. Cantarutti's green choice in the use of Bio stains contributes to the search for a conscious and sustainable style of design and life, without sacrificing the highest quality and resistance performance to:

- Hot and cold liquids (UNI EN 12720)
- Scratches and engravings (UNI EN 151869 and 10782)
- Temperature changes (UNI 9429)
- Yellowing (UNI EN 15187)

Thanks to their compositions, the stains used also comply with the EN 71-3: 2013 standard which certifies the safety of toys. In addition to ergonomics and aesthetic taste, in which the company collaborates with some of the most talented designers, for Cantarutti sustainability and respect for the environment are equally fundamental values on which to base the creation of its collections, with the daily commitment to produce in a responsible and conscious way.





## MATERIALI a cura di Giulio Ridolfo

Porosità, densità, plasticità, tattilità, senso di accoglienza ed abbraccio, riverbero e luminosità... La ricerca mi ha portato a considerare in profondità queste qualità nel corso del mettere insieme volumi, lignei e tessili, trasparenze e matericità, curvature e linee morbide. Giunti, unioni di forme di legno tra di loro, o combinate a parti ricoperte in tessuto, per creare situazioni di condivisione ad un tavolo, o di raccoglimento e comfort. Per un gesto che si perpetua da tempi lontani, l'azione del sedersi e sentirsi accolti in un proprio spazio, che vuole dire provare un senso armonico tra l'abbraccio delle forme. Mettendo in relazione i colori delle essenze ricercate e catalogate – faggio e frassino, con aspetti di rifiniture naturali, sincere, sostenibili per approfondimento sulla loro composizione organica. Rifiniture dai toni naturali, nordici, per passare ai toni caldi del biondo rovere o dei rossastri del ciliegio e mogano, fino ai quasi neri, fumé. Non tralasciando rifiniture a poro aperto, opacità e lucentezze. Accompagnate a tessili sottili o sostenuti, trattati come se fossero un abito maschile, forte di trama ma adatto ad essere modellato su misura. Con stagionalità diverse e forse un occhio alle regionalità che un mondo troppo connesso, tende a disperdere.

## MATERIALS curated by Giulio Ridolfo

Porosity, density, plasticity, tactility, a sense of welcome and embrace, reverberation and brightness... Research has led me to consider these qualities in depth in the course of compiling volumes, wood and textiles, transparencies and materials, curves and soft lines. Connections, wooden shapes joined together, or combined with parts upholstered in fabric, to create situations of sharing across a table, or of meditation and comfort. For a gesture that has been perpetuated since ancient times, the action of sitting and feeling welcomed in your own space, means feeling a harmonious sense between the embrace of forms. By relating the colours of the sought-after and catalogued essences — beech and ash, with aspects of natural, sincere, sustainable finishes for in-depth analysis of their organic composition. Finishes with natural, Nordic tones, continue from the warm tones of blond oak or the reddish hue of cherry and mahogany, up to almost black, smoky tones. Not forgetting open-pore finishes, opacity and shine. Accompanied with thin or sustained textiles, carefully considered as if they were a masculine suit, strong in texture but tailored for precise made to measure applications. With different seasonality and perhaps an eye to the regionality that, a world that is too connected tends to disperse.



## Tinte, Stained wood

Faggio  
Beech



Faggio Sbiancato  
Sleached Beech

Faggio Naturale  
Natural Beech

Rovere Biondo  
Blonde Oak

Noce Canaletto  
Canaletto Walnut

Ciliegio  
Cherry Tree

Noce Intenso  
Intense Walnut

Wengè  
Wengè

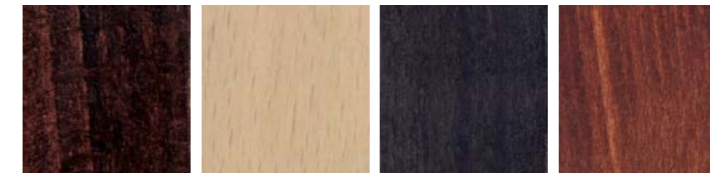

Mogano Scuro  
Dark Mahogany

Rovere Naturale  
Natural Ash

Grey Mocha  
Grey Mocha

Mogano Chiaro  
Light Mahogany

Frassino  
Ash

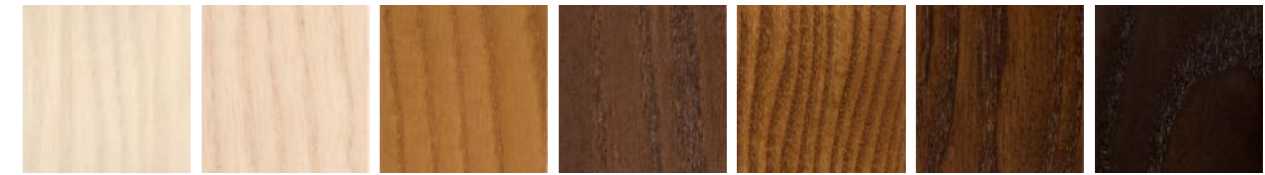

Frassino Sbiancato  
Bleached Ash

Frassino Naturale  
Natural Ash

Rovere Biondo  
Blonde Oak

Noce Canaletto  
Canaletto Walnut

Ciliegio  
Cherry Tree

Noce Intenso  
Intense Walnut

Wengè  
Wengè



Mogano Scuro  
Dark Mahogany

Rovere Naturale  
Natural Oak

Grey Mocha  
Grey Mocha

Mogano Chiaro  
Light Mahogany

## Aniline, Anilines

Faggio  
Beech

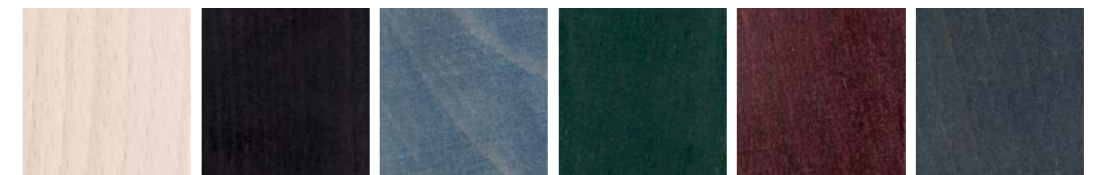

Bianco  
White

Nero  
Black

Light Blue  
RAL 5014

Green  
RAL 6012

Red  
RAL 3007

Grey  
RAL 7024

Frassino  
Ash

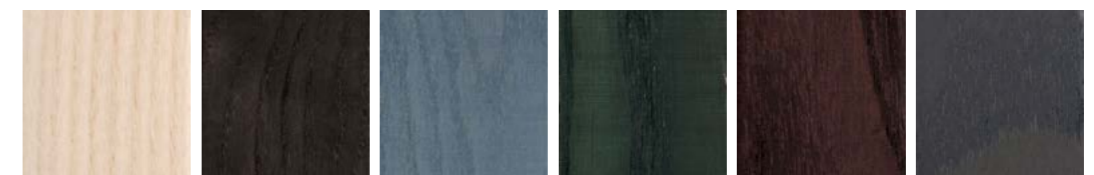

Bianco  
White

Nero  
Black

Light Blue  
RAL 5014

Green  
RAL 6012

Red  
RAL 3007

Grey  
RAL 7024



Laccati, Lacquered

Faggio  
Beech

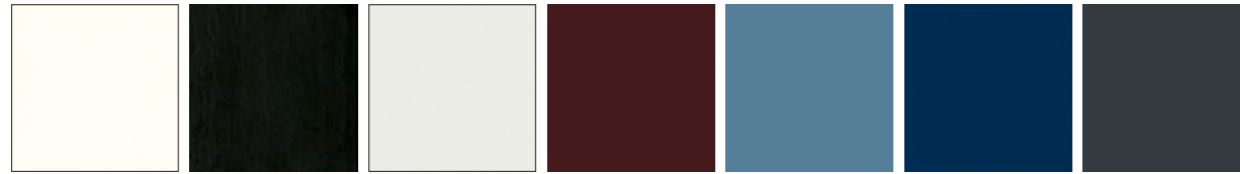

Bianco White Nero Black Grey White RAL 9002 Black Red RAL 3007 Pigeon Blue RAL 5014 Cobalt Blue RAL 5013 Anthracite Grey RAL 7016



Platinum Grey RAL 7036 Pale Brown RAL 8025 Beige NCS 3005-Y50R Black Green RAL 6012 Pure Red RAL 3028 Sulfur Yellow RAL 1016

Frassino  
Ash

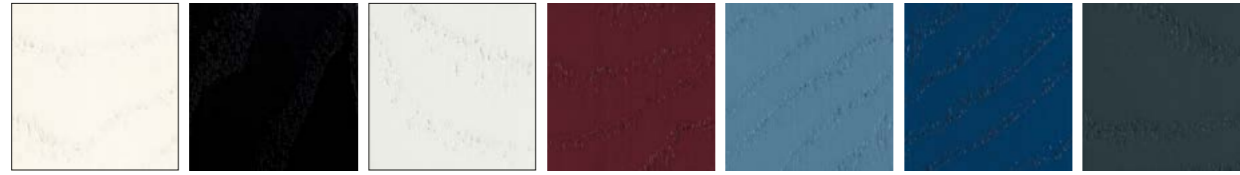

Bianco White Nero Black Grey White RAL 9002 Black Red RAL 3007 Pigeon Blue RAL 5014 Cobalt Blue RAL 5013 Anthracite Grey RAL 7016



Platinum Grey RAL 7036 Pale Brown RAL 8025 Beige NCS 3005-Y50R Black Green RAL 6012 Pure Red RAL 3028 Sulfur Yellow RAL 1016

Laminati, Laminates

Colori  
Colors

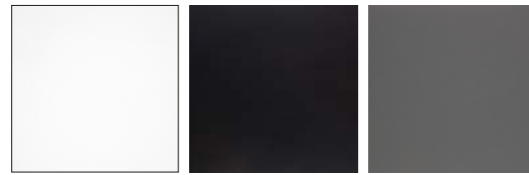

Bianco White Nero Black Grigio Grey

Metalli, Metals

Colori  
Colors



Bianco White Nero Black Anthracite Grey RAL 7016

Filo di carta, Paper cord

Colori  
Colors



Avana

TESSUTI, FABRICS





Tessuti, Fabrics



Tessuti, Fabrics

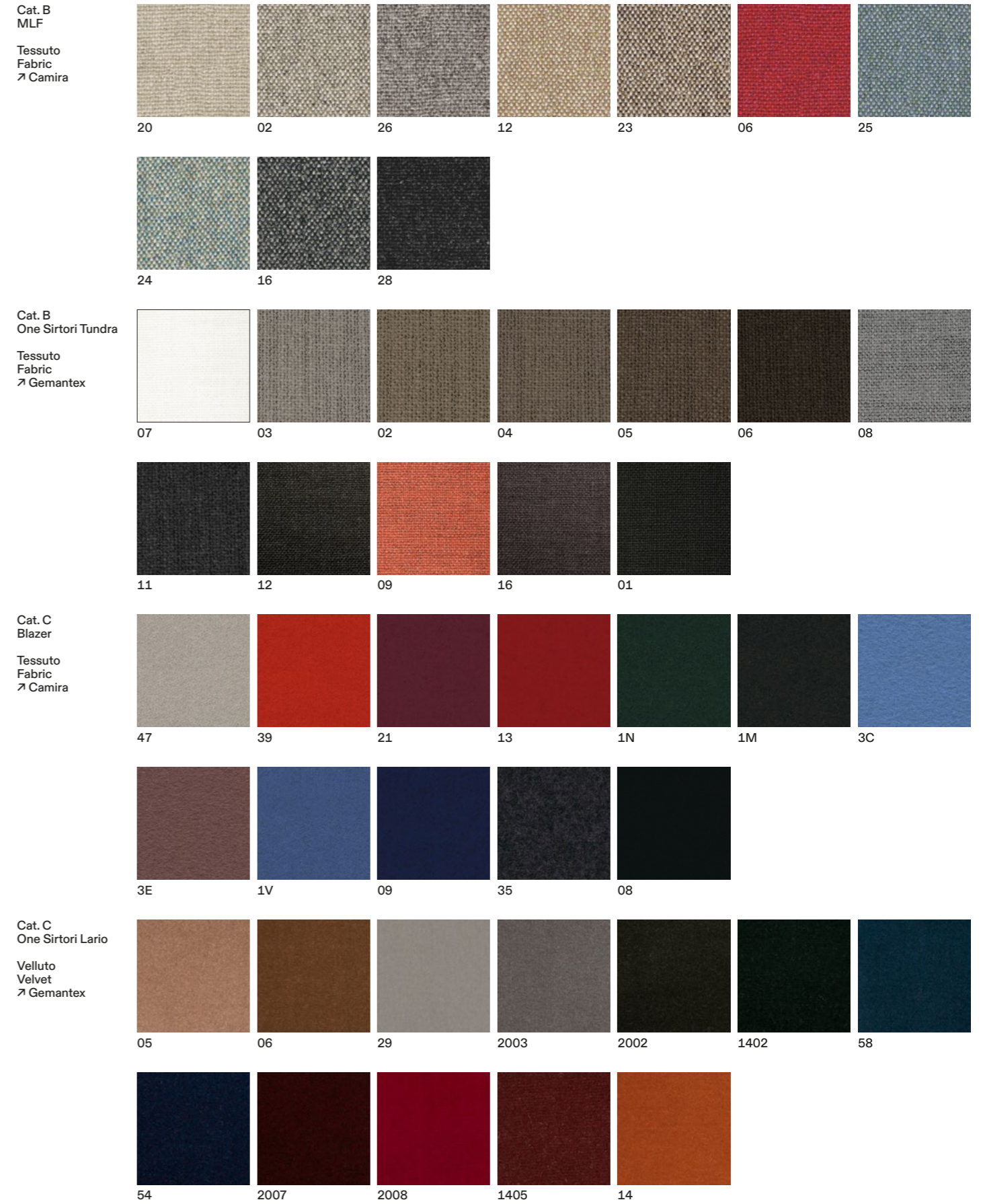



Tessuti, Fabrics

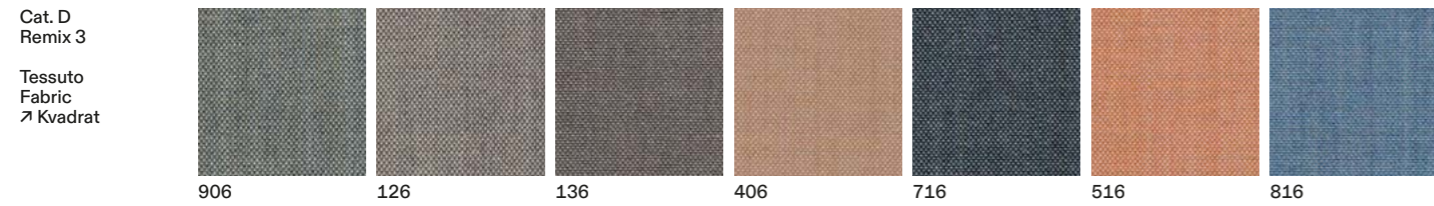
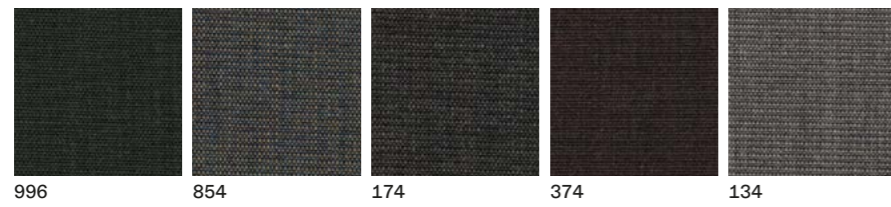
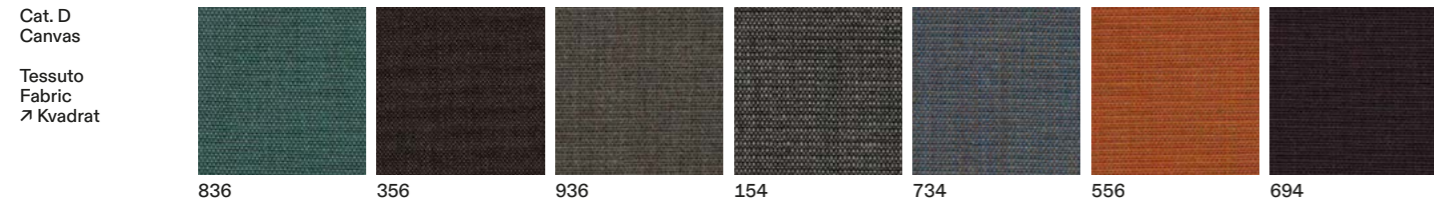
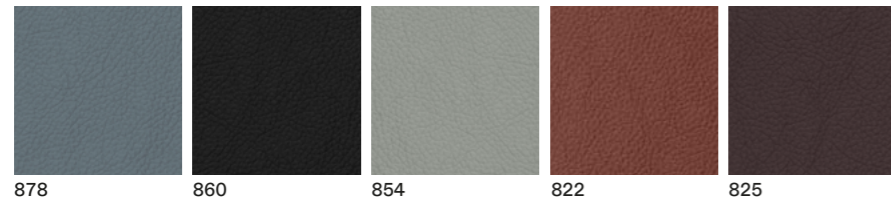
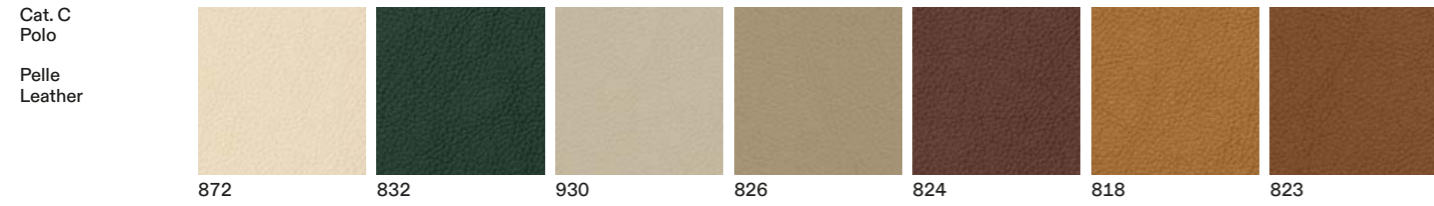

Tessuti, Fabrics

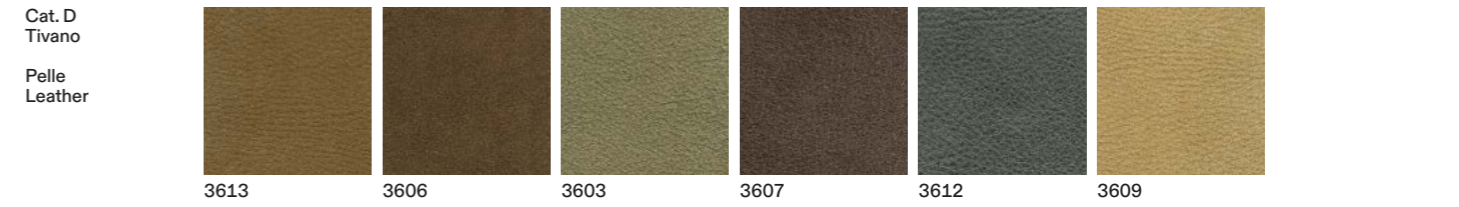
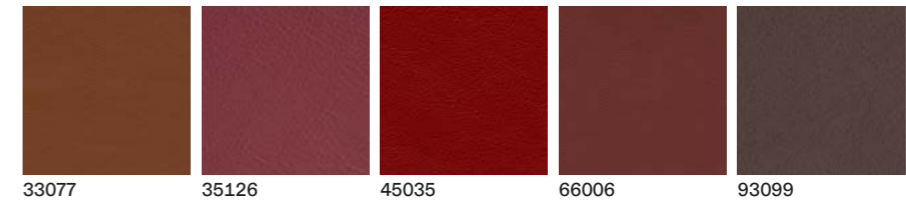
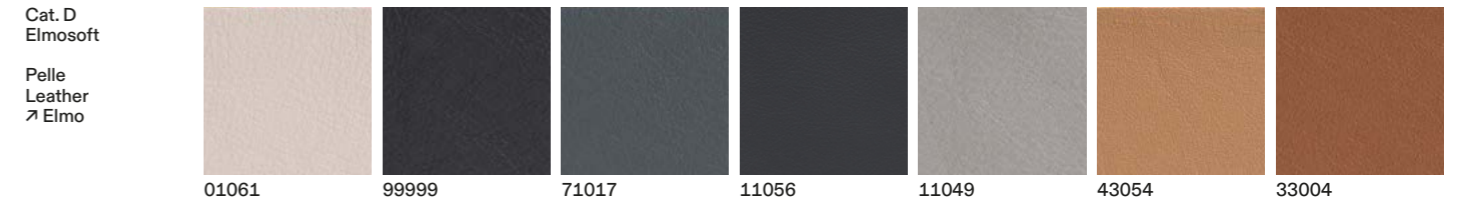
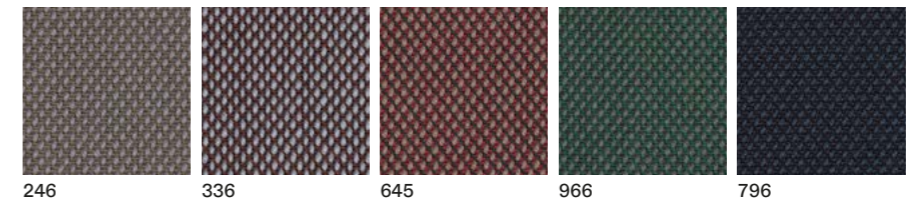
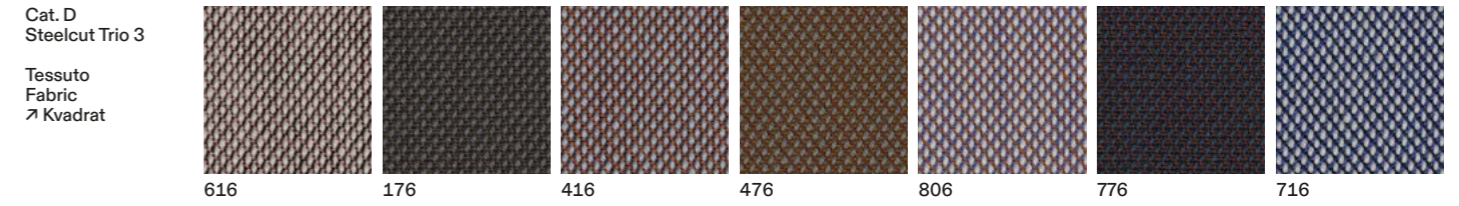



Tessuti, Fabrics

ECO

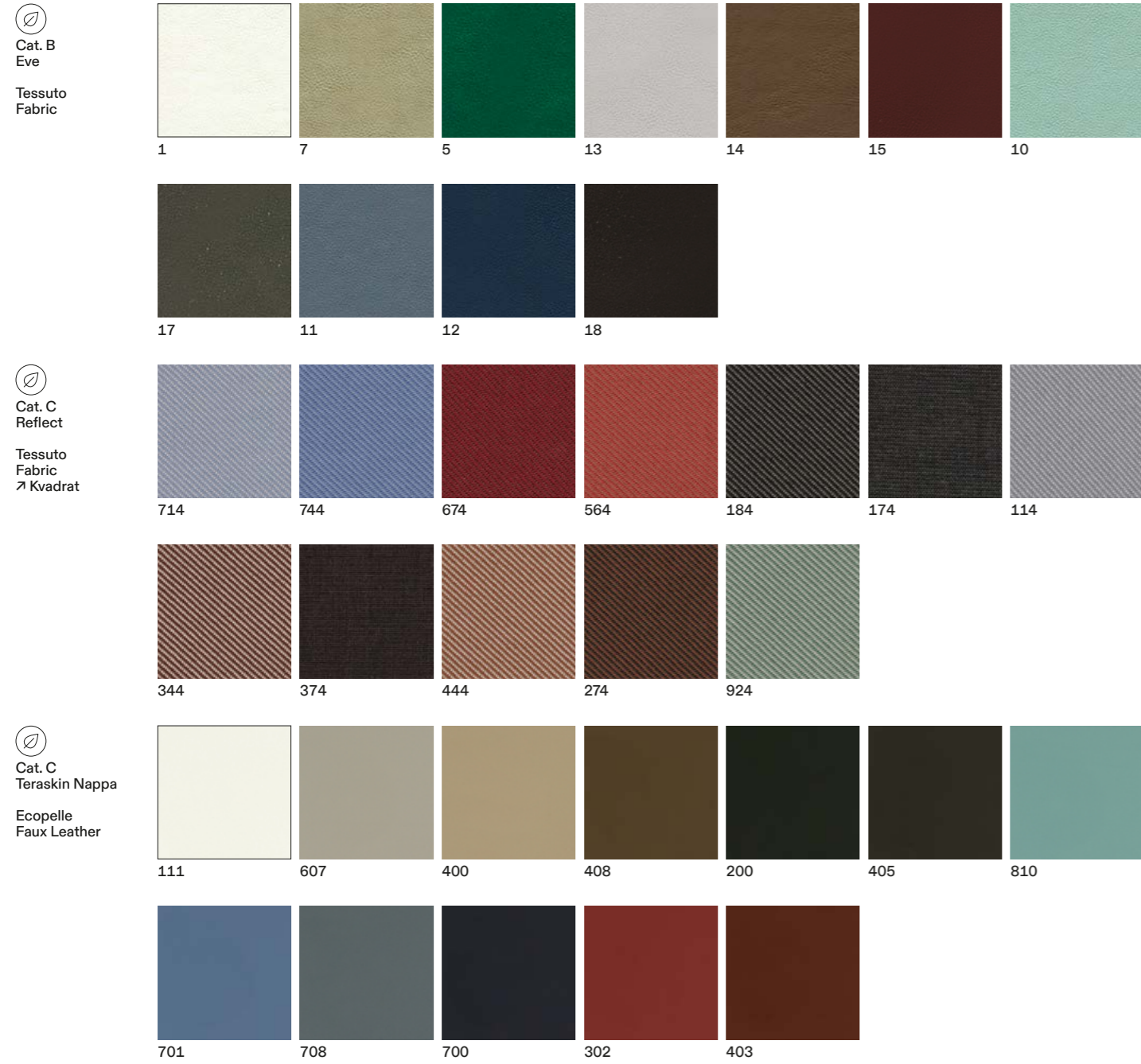

“Extra” Tessuti per servizi fotografici  
 “Extra” Fabrics for photo shooting

Basel  
 Divina  
 Uniform  
 Vidar  
 Zanzibar  
 ↗ Kvadrat  
 ↗ Kvadrat  
 ↗ Kvadrat  
 ↗ Vescom

Tessuti, Fabrics

OUTDOOR

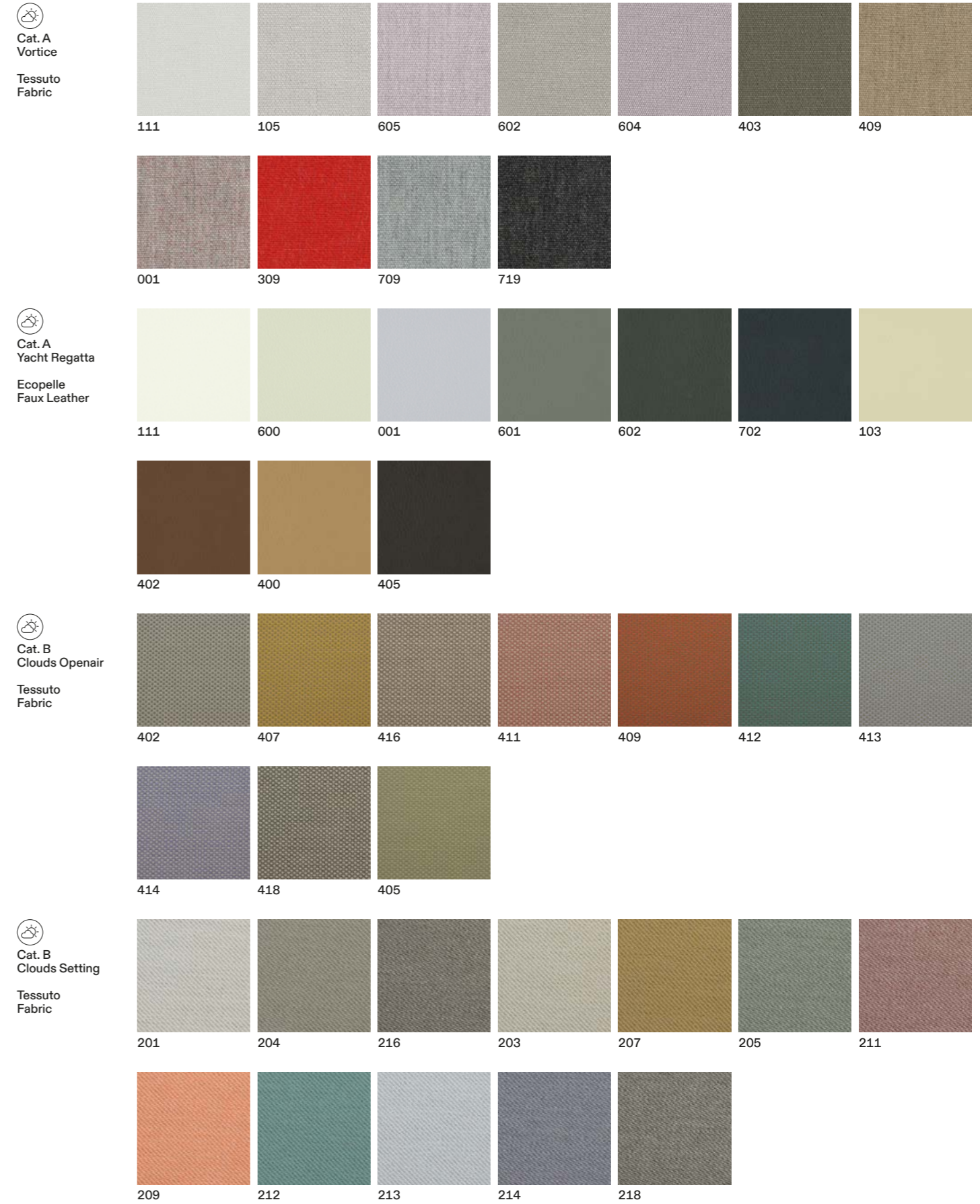



Cantarutti s.r.l.

via Maggiore, 14  
33040 Premariacco (Udine)  
T. +39 0432 72 05 18  
F. +39 0432 72 09 42  
info@cantarutti.net  
cantarutti.net

**cantarutti**

Colour Consultant  
Giulio Ridolfo

Graphic Design  
Think Work Observe

Photography  
Mattia Balsamini  
Think Work Observe

3D Images  
Studio Gianluca Busetti

Post production  
and printing  
Grafiche Filacorda



