

TABLE GUN

Designed by R. & Philippe Starck, 2005

F2954000

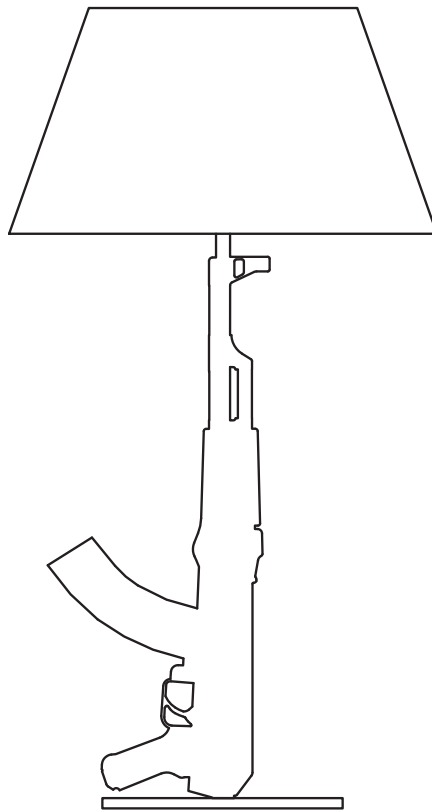
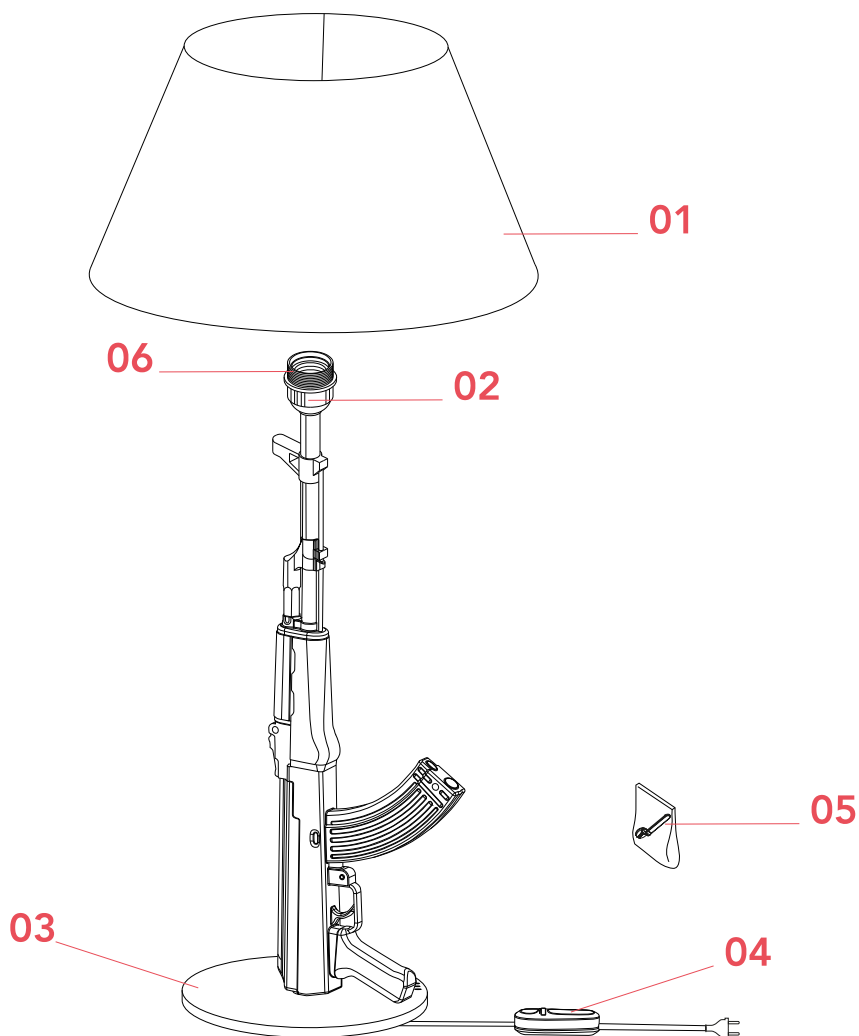

TABLE GUN

F2954000

EN



- 01. F2962030** – Black diffuser
- 02. RF13750** – Black E27 lamp holder
- 03. RF27093** – Glossy gold lux base assembly
- 04. RF28206** – Led dimmer 1004P LFP100-240V 4-150WHL 4-25W
- 05. RF13905** – Locking key tool
- 06. RF11919** – Ring nut

TABLE GUN F2954000

EN

F2962030

BLACK DIFFUSER ASSEMBLY



WARNING! When installing and whenever acting on the appliance, ensure that the power supply has been switched off.
For the installation of the spare-part, it is necessary to consult a qualified electrician.

©2021 Flos - All rights reserved - www.flos.com
Flos reserves the right to introduce any changes to its own models, without prior notice.

TABLE GUN F2954000

EN

F2962030

BLACK DIFFUSER ASSEMBLY

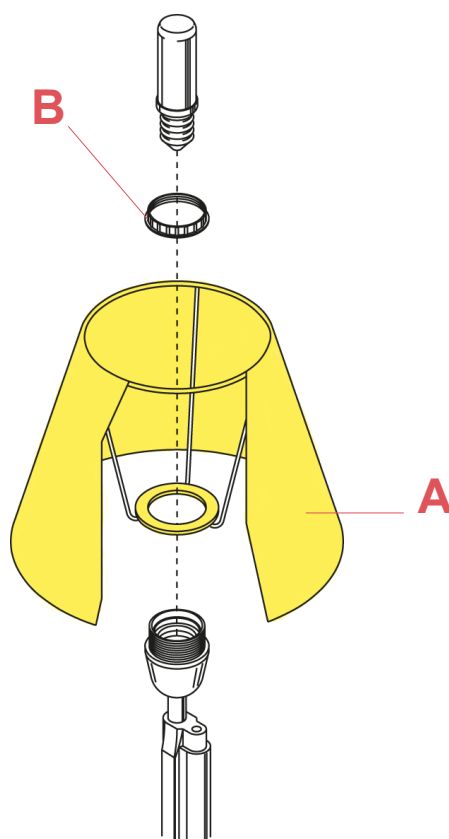

Fig.1

Unfasten-off the lamp-bulb.
Remove the diffuser (A) by unfastening the locking nut (B).

Assemble now the new spare-part:
Position by collocating the diffuser (A) on the body and lock it by fastening the
locking nut (B).
Insert the lamp-bulb.

WARNING! When installing and whenever acting on the appliance, ensure that the power supply has been switched off.
For the installation of the spare-part, it is necessary to consult a qualified electrician.

©2021 Flos - All rights reserved - www.flos.com
Flos reserves the right to introduce any changes to its own models, without prior notice.

TABLE GUN F2954000

EN

RF13750

BLACK E27 LAMP HOLDER



Bedside
Gun
p.05



Lounge
Gun
p.05

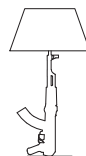

Table
Gun
p.05

WARNING! When installing and whenever acting on the appliance, ensure that the power supply has been switched off.
For the installation of the spare-part, it is necessary to consult a qualified electrician.

TABLE GUN F2954000

EN

RF13750

BLACK E27 LAMP HOLDER



Fig.1



Fig.2

By utilizing a tiny flat screw driver, carefully push towards the inside the side spring of the lamp holder in away to free the sleeve of the lamp holder;

WARNING! When installing and whenever acting on the appliance, ensure that the power supply has been switched off. For the installation of the spare-part, it is necessary to consult a qualified electrician.

©2021 Flos - All rights reserved - www.flos.com
Flos reserves the right to introduce any changes to its own models, without prior notice.

TABLE GUN F2954000

EN

RF13750

BLACK E27 LAMP HOLDER



Fig.3



Fig.4

Unfasten the sleeve from the lamp holder assembly;

WARNING! When installing and whenever acting on the appliance, ensure that the power supply has been switched off.
For the installation of the spare-part, it is necessary to consult a qualified electrician.

TABLE GUN F2954000

EN

RF13750

BLACK E27 LAMP HOLDER

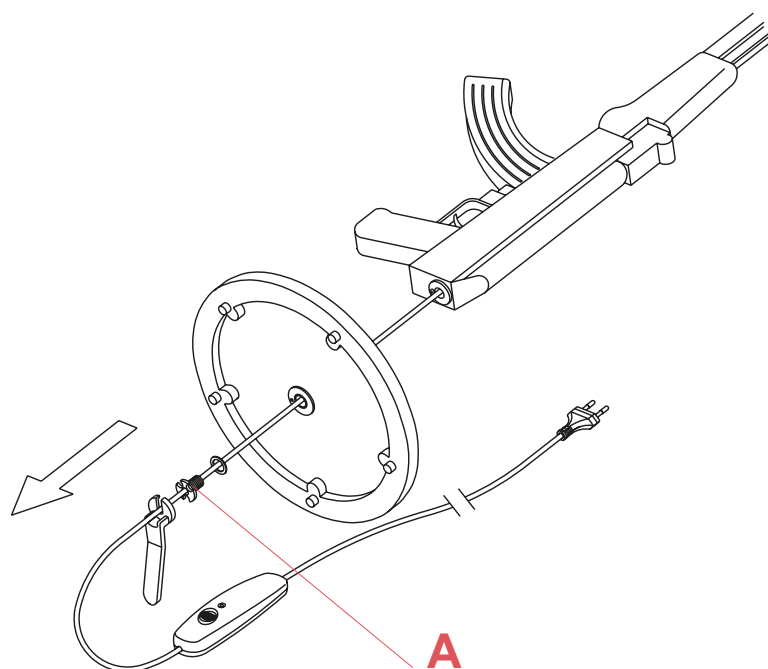

Fig.5

To free the electrical cable, unfasten the locking screw (A) from under the base;
Delicately pull-up the electrical cable to have access to the electrical terminal lamp
holder contacts;

Disconnect the wires and free the black lamp holder support by unfastening the
screw through a flat tiny screw driver;

Assemble now the new spare-part:

Install the lamp holder support, connect the lamp holder contacts, push down the
electrical cable, fasten back the lamp holder sleeve, push back in position the lateral
spring and for last, fasten the locking screw under the base.

WARNING! When installing and whenever acting on the appliance, ensure that the power supply has been switched off.
For the installation of the spare-part, it is necessary to consult a qualified electrician.

©2021 Flos - All rights reserved - www.flos.com
Flos reserves the right to introduce any changes to its own models, without prior notice.

TABLE GUN F2954000

EN

RF27093

BASE ASSEMBLY

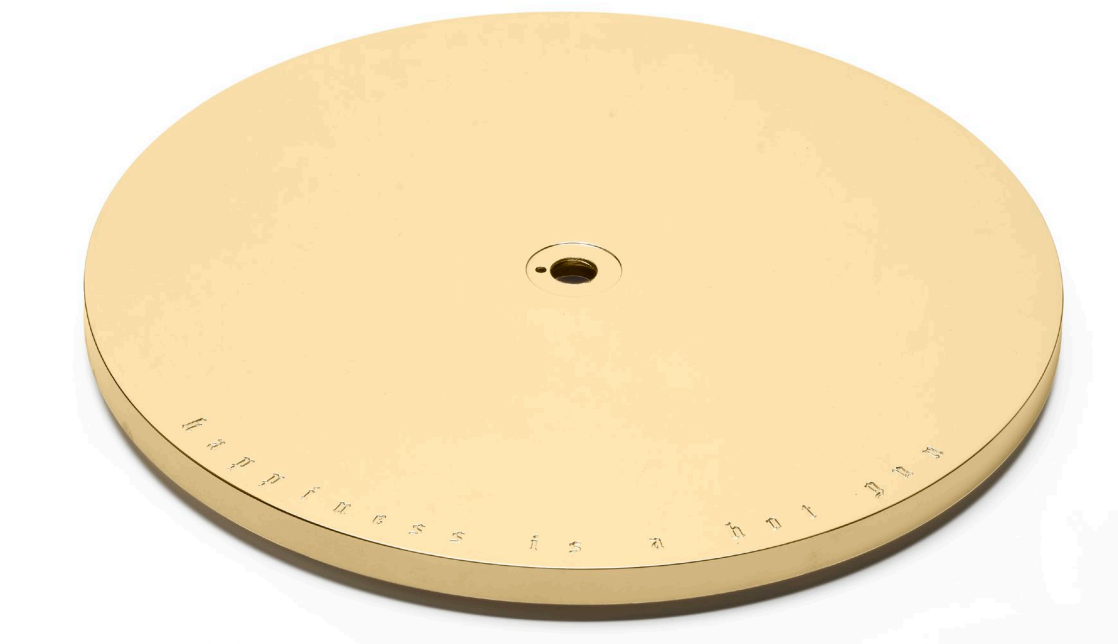

WARNING! When installing and whenever acting on the appliance, ensure that the power supply has been switched off.
For the installation of the spare-part, it is necessary to consult a qualified electrician.

©2021 Flos - All rights reserved - www.flos.com
Flos reserves the right to introduce any changes to its own models, without prior notice.

RF27093

BASE ASSEMBLY

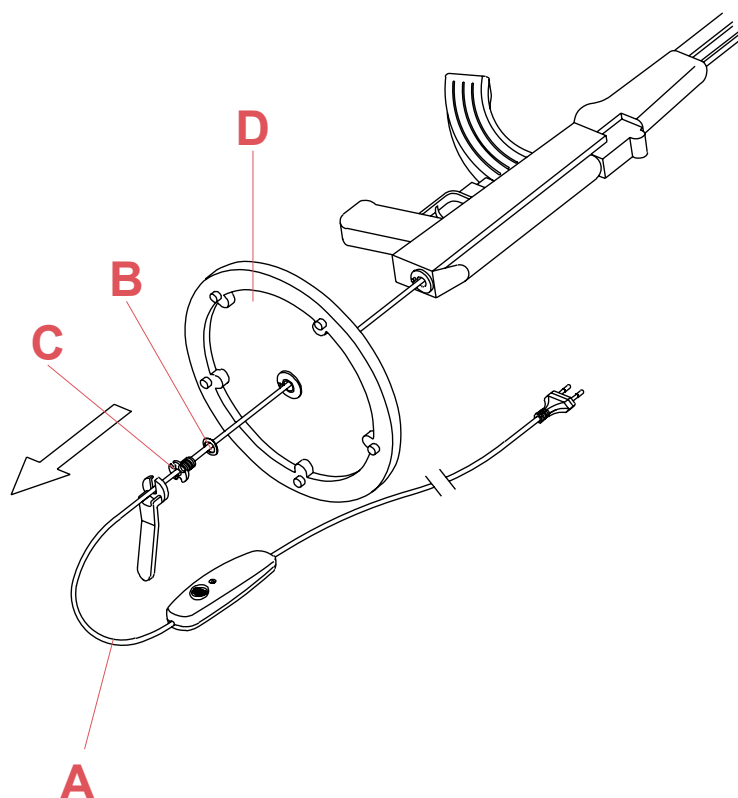

Fig.1

- Disconnect from the dimmer the electrical cable (A) that goes to the lamp structure and free the cable through the cable clamps;
- Unfasten the locking screw (C) from the base and slide it out from the electrical cable (A);
- Slide out the washer (B) and the damaged base (D);
- Slide through the cable (A) the new base (D), following the washer (B) and then the locking screw (C).
- Connect the lamp structure electrical cable (A) back to the dimmer and then lock the cable through its opposite cable clamp.

WARNING! When installing and whenever acting on the appliance, ensure that the power supply has been switched off.
For the installation of the spare-part, it is necessary to consult a qualified electrician.

TABLE GUN F2954000

EN

RF27093

BASE ASSEMBLY

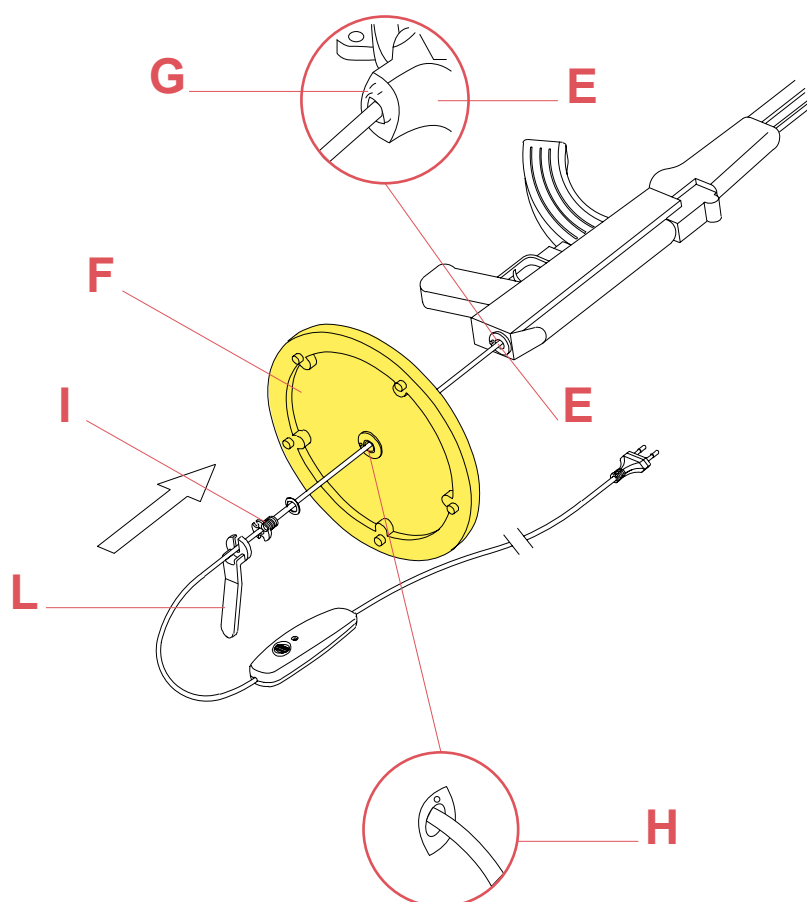

Fig.2

Position the lamp structure (E) on the base (F) ensuring that the safety pin (G) enters in its appropriate hole (H);
Lock the base (F) on to the lamp structure (E) by tightening the locking screw (L) with a tool key (I).

WARNING! When installing and whenever acting on the appliance, ensure that the power supply has been switched off.
For the installation of the spare-part, it is necessary to consult a qualified electrician.

©2021 Flos - All rights reserved - www.flos.com
Flos reserves the right to introduce any changes to its own models, without prior notice.











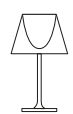



TABLE GUN F2954000

EN

RF28206

DIMMER LED 1004P LFP100-240V 4-150WHL 4-25W

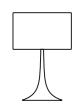
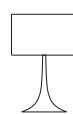
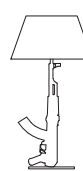

								
Bedside Gun p.12	Chiara T p.03	Glo-ball Basic 0 p.11	Glo-ball Basic 1 p.14	Glo-ball Basic 2 p.05	Glo-ball T1 p.11	Ic T1 High p.08	Ic T1 Low p.08	Ic T2 p.08
								
Ktribe T1 p.05	Ktribe T2 p.05	Miss K p.13	Ray T p.17	Romeo Moon T1 p.32	Romeo Soft T1 p.32	Spun Light T1 p.12	Spun Light T2 p.12	Table Gun p.12

WARNING! When installing and whenever acting on the appliance, ensure that the power supply has been switched off.
For the installation of the spare-part, it is necessary to consult a qualified electrician.

TABLE GUN F2954000

EN

RF28206

LED DIMMER 1004P LFP100-240V 4-150WHL 4-25W



Fig.1

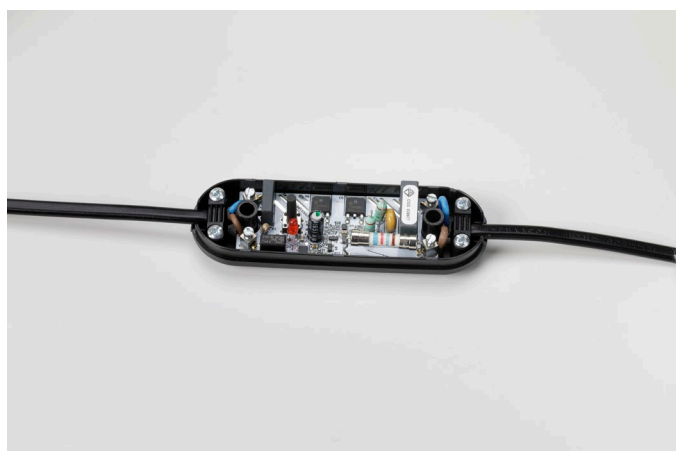

Fig.2

Open the dimmer box of the damaged dimmer. For the opening, it is necessary to remove the n°2 screws using a star screw driver.

Lift-up the dimmer casing from the dimmer base;

WARNING! When installing and whenever acting on the appliance, ensure that the power supply has been switched off. For the installation of the spare-part, it is necessary to consult a qualified electrician.

TABLE GUN F2954000

EN

RF28206

LED DIMMER 1004P LFP100-240V 4-150WHL 4-25W

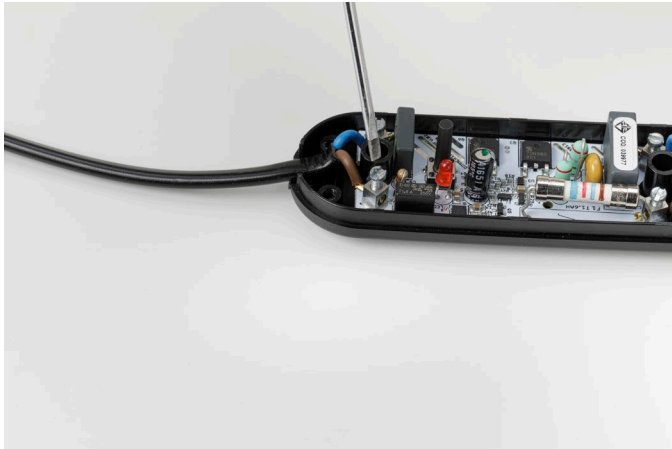

Fig.3

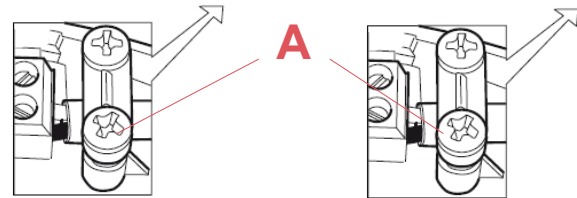

Fig.3.1

Remove the cable clamps by unfastening the 4 screws (A) and disconnect the wires from the terminal blocks through a tiny flat headed screw driver;



Fig.4

Replace the dimmer and connect the wires. When connecting the wires it is necessary to respect the polarities (L = Brown and N = Blue) to the terminal box.

Lock the electrical cables by fastening the screws (A) of the cable clamps and make sure to block the isolation of the electrical cable.

Close the dimmer box.

It is necessary to place the casing on top and press down until it locks in.

it is necessary to insert the n°2 screws using a star screw driver

WARNING! When installing and whenever acting on the appliance, ensure that the power supply has been switched off. For the installation of the spare-part, it is necessary to consult a qualified electrician.

TABLE GUN F2954000

EN

RF13905

LOCKING KEY TOOL



Bedside
Gun
p.15

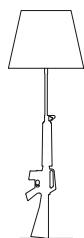

Lounge
Gun
p.17



Table
F
p.05

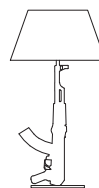

Table
Gun
p.15

WARNING! When installing and whenever acting on the appliance, ensure that the power supply has been switched off.
For the installation of the spare-part, it is necessary to consult a qualified electrician.

TABLE GUN F2954000

EN

RF13905

LOCKING KEY TOOL

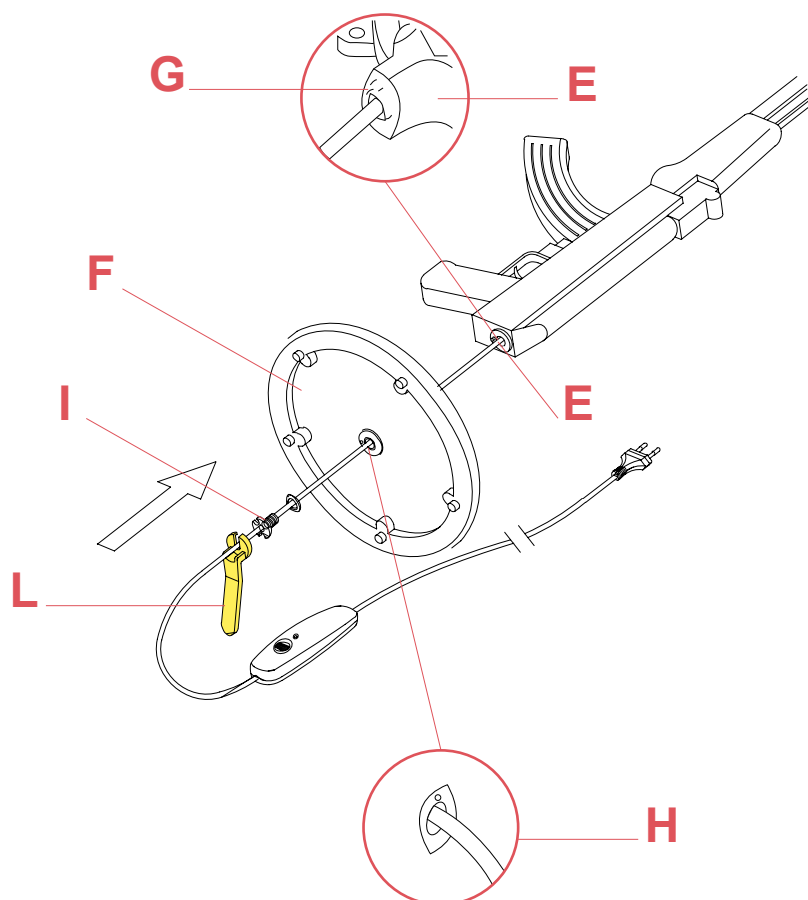

Fig.1

Position the lamp structure (E) on the base (F) ensuring that the safety pin (G) enters in its appropriate hole (H);
Lock the base (F) on to the lamp structure (E) by tightening the locking screw (I) with the tool key (L).

WARNING! When installing and whenever acting on the appliance, ensure that the power supply has been switched off.
For the installation of the spare-part, it is necessary to consult a qualified electrician.

©2021 Flos - All rights reserved - www.flos.com
Flos reserves the right to introduce any changes to its own models, without prior notice.

TABLE GUN F2954000

EN

RF11919

RING NUT



Bedside
Gun
p.17

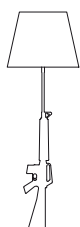

Lounge
Gun
p.09

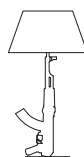

Table
Gun
p.17



Snoopy
p.15

WARNING! When installing and whenever acting on the appliance, ensure that the power supply has been switched off.
For the installation of the spare-part, it is necessary to consult a qualified electrician.

TABLE GUN F2954000

EN

RF11919

RING NUT

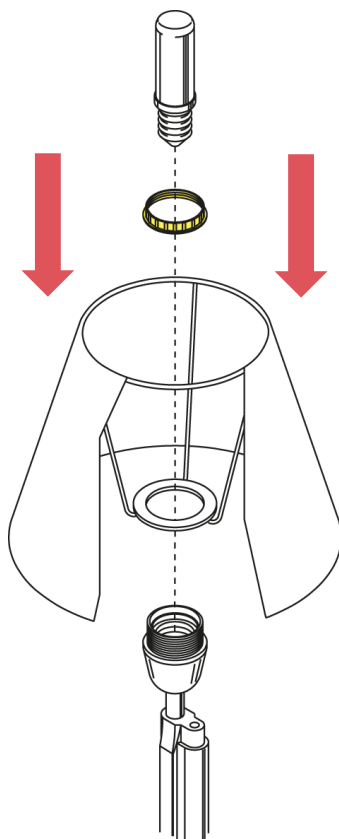

Fig.1

Place the diffuser on the main body.
Lock the diffuser by fastening the new locking nut and insert the lamp bulb.

WARNING! When installing and whenever acting on the appliance, ensure that the power supply has been switched off.
For the installation of the spare-part, it is necessary to consult a qualified electrician.

©2021 Flos - All rights reserved - www.flos.com
Flos reserves the right to introduce any changes to its own models, without prior notice.