

# BARTOLOMEO DESK

DESIGN  
JOEVELLUTO (JMLT)  
2013

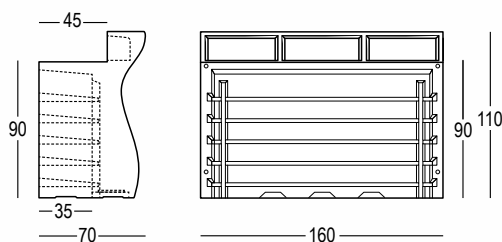

Versione **light** /  
**Light version**

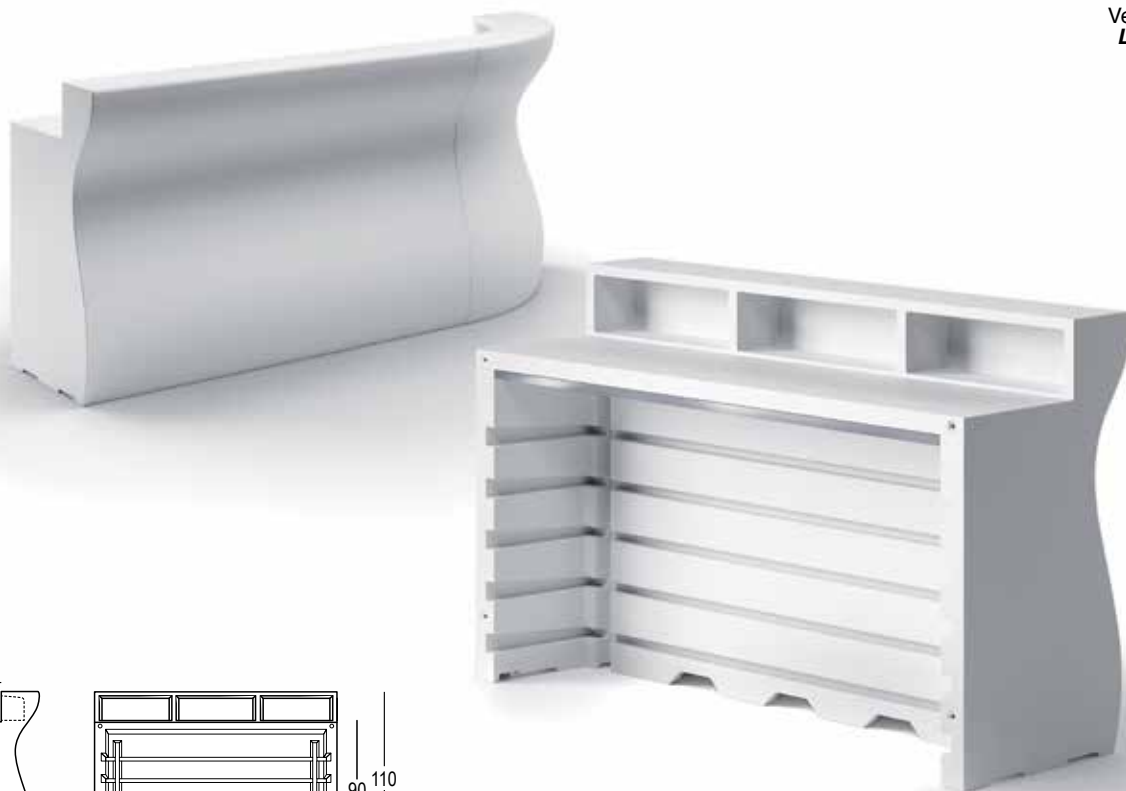

## Materials:

Polietilene / *Polyethylene*  
Alluminio / *Aluminum*  
Inox / *Inox (only Version 1, 2, 3)*

## Gross Weight:

Art. 6277 - Kg 60,8  
Art. 6286 - Kg 64  
Art. 6287 - Kg 65,4  
Art. 6288 - Kg 66,8

Use: **INDOOR / OUTDOOR**

## Details:

Piedini regolabili / *Adjustable feet*  
Kit di fissaggio / *Fixing kit*  
Profilo in alluminio / *Aluminum rod*

Banco bar modulare dalla morbida linea estetica, solido e di facile manutenzione. Predisposto per accogliere 5 mensole di stoccaggio, presenta 3 nicchie per l'utilizzo operativo ed è predisposto per un piano di copertura. Permette di creare infinite soluzioni strutturali: postazioni reception, banconi lineari e piano alto per buffet. La gamma completa di accessori bar e la versione Light, lo rendono un prodotto versatile e adatto all'uso sia indoor che outdoor.

*A solid, easy-maintenance modular bar counter with a smooth design. It can contain 5 shelves and has 3 niches. It is designed to enable the installation of a countertop. It allows the creation of infinite structural solutions: reception desks, linear bar counters, and buffet consoles. The full range of bar accessories and its Light version makes "Bartolomeo" a versatile product for indoor and outdoor use.*

## COLORI BASE / BASIC COLOURS

Art. 6277 | BARTOLOMEO DESK

Art. 6286 | BARTOLOMEO DESK VERSION 1

Art. 6287 | BARTOLOMEO DESK VERSION 2

Art. 6288 | BARTOLOMEO DESK VERSION 3

C2  Bianco C2  
White C2

# BARTOLOMEO DESK VERSIONI / BARTOLOMEO DESK VERSIONS

---



**VERSION 1**



**VERSION 2**



**VERSION 3**

# BARTOLOMEO DESK VERSIONI / BARTOLOMEO DESK VERSIONS

## INDOOR / OUTDOOR

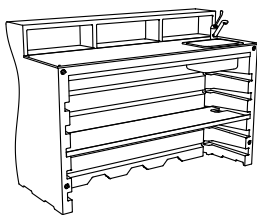

Art. 6286 | BARTOLOMEO DESK VERSION 1  
Art. 8286 | BARTOLOMEO DESK LIGHT VERSION 1

Materials:  
Polietilene / Polyethylene  
Alluminio / Aluminum  
Inox / Inox

Gross Weight: Kg 64

Details:  
Piedini regolabili / Adjustable feet  
Kit di fissaggio / Fixing kit  
Profilo in alluminio / Aluminum rod  
Piano in PE alimentare / PE FDA top  
Lavandino in inox / Inox sink  
Piletta di scarico / Waste water drain  
Rubinetto / Tap  
Mensola con foro / Shelf with hole

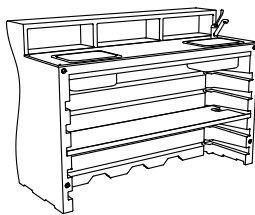

Art. 6287 | BARTOLOMEO DESK VERSION 2  
Art. 8287 | BARTOLOMEO DESK LIGHT VERSION 2

Materials:  
Polietilene / Polyethylene  
Alluminio / Aluminum  
Inox / Inox

Gross Weight: Kg 65,4

Details:  
Piedini regolabili / Adjustable feet  
Kit di fissaggio / Fixing kit  
Profilo in alluminio / Aluminum rod  
Piano in PE alimentare / PE FDA top  
Lavandino in inox / Inox sink  
Piletta di scarico / Waste water drain  
Rubinetto / Tap  
Mensola con foro / Shelf with hole  
Ghiacciaia in inox / Inox ice box

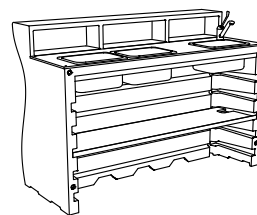

Art. 6288 | BARTOLOMEO DESK VERSION 3  
Art. 8288 | BARTOLOMEO DESK LIGHT VERSION 3

Materials:  
Polietilene / Polyethylene  
Alluminio / Aluminum  
Inox / Inox

Gross Weight: Kg 66,8

Details:  
Piedini regolabili / Adjustable feet  
Kit di fissaggio / Fixing kit  
Profilo in alluminio / Aluminum rod  
Piano in PE alimentare / PE FDA top  
Lavandino in inox / Inox sink  
Piletta di scarico / Waste water drain  
Rubinetto / Tap  
Mensola con foro / Shelf with hole  
2 x ghiacciaia in inox / 2 x inox ice box

## BARTOLOMEO FAMILY ACCESSORI / ACCESSORIES

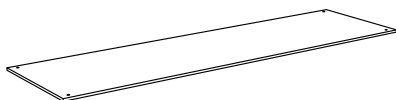

Art. A4400 | BARTOLOMEO PIANO / TOP

Materials:  
Polietilene alimentare / FDA polyethylene

Gross Weight: Kg 7,5

Use: **INDOOR / OUTDOOR**

Details:  
Completo di 4 viti in inox / With 4 inox screws

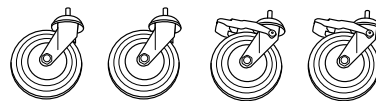

Art. A4409 | KIT 4 RUOTE / 4 WHEELS KIT

Materials:  
Acciaio / Iron  
Gomma / Rubber

Gross Weight: Kg 1,6

Use: **INDOOR / OUTDOOR**

Details:  
2 ruote senza freno + 2 ruote con freno / 2 wheels without brake system + 2 wheels with brake system  
Per Bartolomeo e Bartolomeo Display / For Bartolomeo and Bartolomeo Display



Art. A4410 | KIT 3 RUOTE / 3 WHEELS KIT

Materials:  
Acciaio / Iron  
Gomma / Rubber

Gross Weight: Kg 1,2

Use: **INDOOR / OUTDOOR**

Details:  
2 ruote senza freno + 1 ruota con freno / 2 wheels without brake system + 1 wheel with brake system  
Per Bartolomeo Corner / For Bartolomeo Corner



Art. A4406 | BARTOLOMEO CORNER PIANO / TOP CORNER

Material:  
Polietilene alimentare / FDA polyethylene

Gross Weight: Kg 2

Use: **INDOOR / OUTDOOR**

Detail:  
Completo di 3 viti in inox / With 3 inox screws