



FLUFFO

Product catalogue

Go on,
cuddle up!

FLUFFO

Fluffo is a Polish manufacturer of soft, acoustic wall panels and more. Fluffo products provide innovative solutions, combining emotions, design and exceptional utility.

Our broad product offer, available in numerous models and colours, caters for all tastes. The excellent acoustic properties allow you to enjoy the comfort and benefits of sound across all interiors.

Throughout Europe thousands of satisfied clients have trusted Fluffo – our panels decorate homes and offices where acoustics left a lot to be desired. The investors compromised neither on aesthetics nor design.



The Fluffo Concept

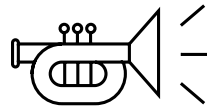

Acoustics

All Fluffo products absorb sound effectively, the secret lies in the open-cell structure of the material we use in their manufacture process. The soundproofing properties of Fluffo panels have been thoroughly tested in the fully accredited acoustic laboratory of the Marine Technology Institute in Gdansk, Poland.

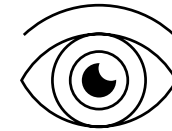

Design

Fluffo stands for elegant and creative design, giving interiors a new and unique style. The panels are a design masterpiece – just a few will completely transform an entire interior.

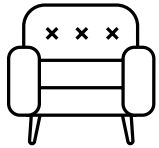
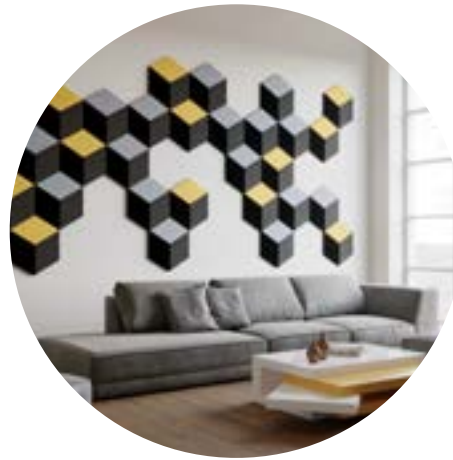

Fluffiness

Fluffo is the new interior design concept, where fluffiness plays a key role. All Fluffo products are covered with a soft finish, made up of millions of colourful polyamide microfibers glued to the surface; they are sensuous and velvety to the touch.

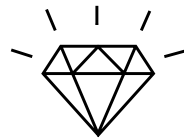

Quality

The Fluffo team comprises of widely experienced industry specialists who select the best materials available thus ensuring that our products possess the very best properties as far as safety, durability and precision are concerned. We are simply the best – inimitable!

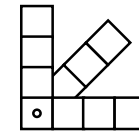

Variety

Fluffo panels come in many complex shapes, sizes and colours. They have both decorative and acoustic applications. The numerous models and dozens of colour choices allow total freedom to create any combination – the possibilities are endless, limited only by your imagination.

Acoustics

Two problems,
two solutions

SOUND ABSORPTION. WHEN THERE IS A REVERBERATION.

All Fluffo products have acoustic properties characterised by their high sound absorption coefficient. They work perfectly in spaces which require an improvement in overall interior acoustics where there is a problem with echoes, reverberation or noise. In other words problems with bothersome sounds created within the room.

Our practical experience shows that covering as little as 20 to 40% of walls with Fluffo panels will work wonders in a room which has a reverberation problem. Echoes are reduced and the room immediately becomes quieter and more cosy.

The acoustic properties of our products were tested in an accredited research institute.

Our extensive range of sound absorbing Fluffo products includes:

- Fluffo SOFT
- Fluffo IZO
- Fluffo WALLCOVERINGS
- Fluffo FIRE RESIST
- Fluffo WEB
- Fluffo ART
- Fluffo AIR
- Fluffo GLASS



SOUND INSULATION. WHEN BOTHERSOME NOISE PENETRATES THE WALLS.

Where there is a problem with noise from outside penetrating the walls (noisy neighbours, adjoining office kitchen) Fluffo IZO, our specially designed, multilayer, decorative, sound insulating wall panels, are the perfect solution.

Fluffo IZO is an alternative to the traditional method – considerable refurbishment, with the accompanying mess, noise and inconvenience it entails.

Fluffo product dedicated to sound insulation:

- Fluffo IZO

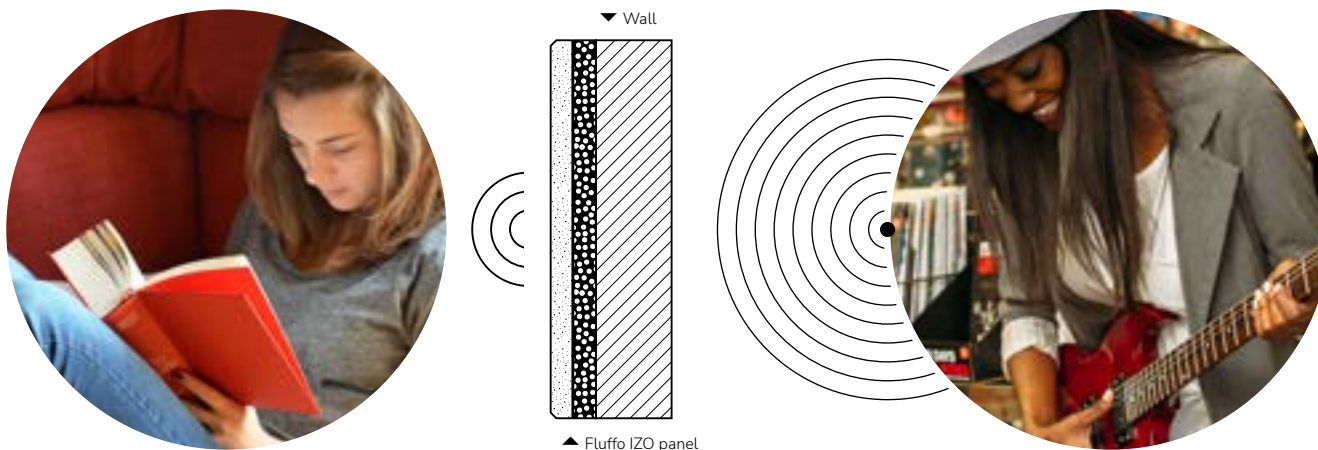

The Fluffo finish

All Fluffo panels are covered with a soft, velvety and sensuous finish, made up of millions of colourful polyamide microfibers glued to the surface.

Go on, cuddle up!

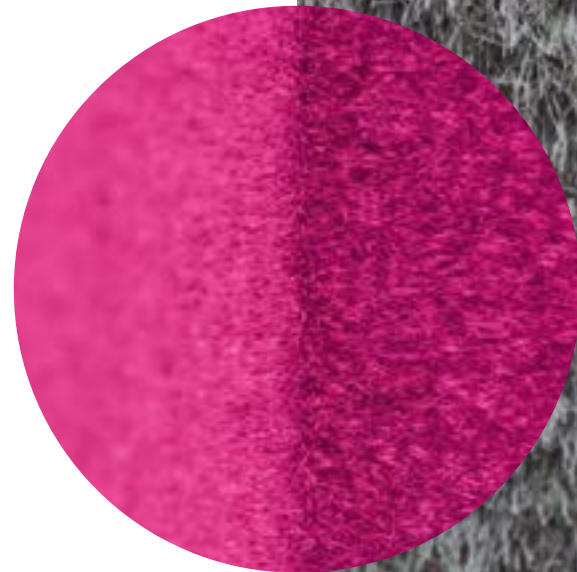

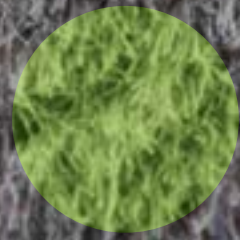
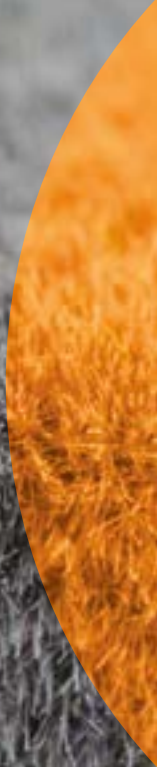

Fluffo Colours

Fluffo is not just about the shape or softness. It is also about the colour, which introduces the desired ambience to your interior, adds positive energy and stimulates creativity. Reflecting current design and fashion trends and matching your lifestyle perfectly.

Choose your colour!



Choose the colour
that suits you

The Fluffo palette
consists of 56 original
colours, feel free to create
any combination you
wish, the possibilities are
endless and only limited
by the extent of your
imagination.



Our favourite Fluffo colour sets

Experience how our colours and their combinations can express emotions, feelings and moods. Get inspired by our sample colour sets and create your own magical world.

Visit www.fluffo.pl and explore our favourite colour combinations.





„Torii Gate”,
sample colour
combination

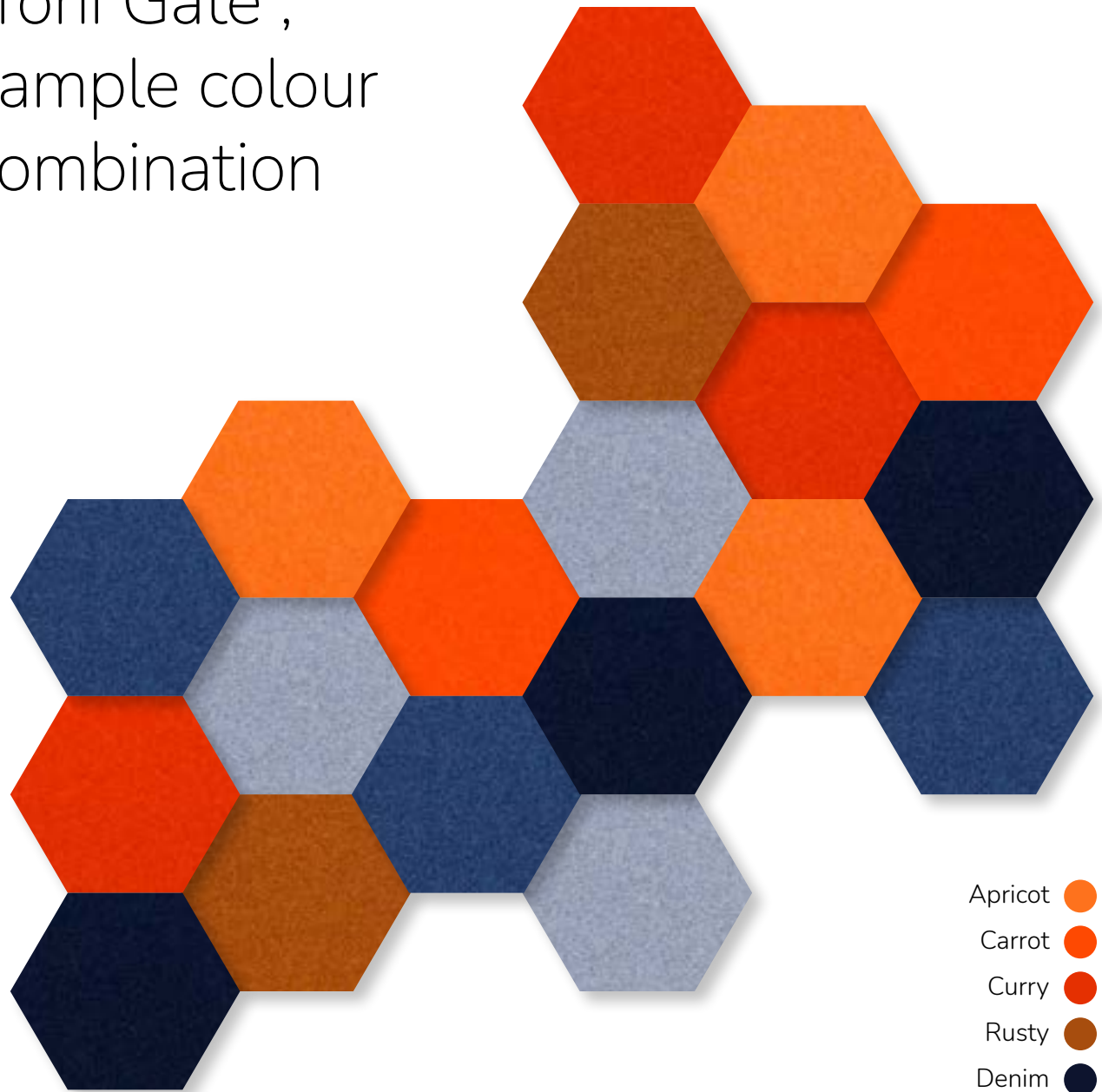

- Apricot ●
- Carrot ●
- Curry ●
- Rusty ●
- Denim ●
- Blue macaw ●
- Winter sky ●

Choose the best solution to fit your needs

Fluffo offers 8 collections, to assist in the creation of a beautiful and functional interior.

Product		Firmness	Acoustic properties	Available thicknesses	Number of colours	Edge	Installation	
SOFT	3D	three-dimensional panels of varied thickness	soft	sound absorption 0,80*	from 20 mm to 50 mm	56	straight	with use of adhesive
	FLAT	flat panels	soft	sound absorption 0,80*	20, 30, 40, 50 mm	56	straight, bevelled on request	with use of adhesive
	EDGE	flat panels with bevelled edge	soft	sound absorption 0,80*	30 mm	56	bevelled on each side	with use of adhesive
	RIFT	flat panels with corrugated surface	soft	sound absorption 0,80*	30 mm	56	predifined straight and bevelled	with use of adhesive
IZO		sound insulating panels	soft	sound absorption 0,80* sound insulation Rw (C;C _v) = 27 (0;-2) dB**	62 mm	56	bevelled	with use of adhesive
WALLCOVERINGS		felt wallcoverings	soft	sound absorption 0,15*	3 mm	20	–	with use of adhesive
FIRE RESIST		fire retardant office wall panels	firm	sound absorption 0,55*	20, 30 mm	56	straight	with use of adhesive
WEB		acoustic curtains	soft	sound absorption 0,80*	40 mm	56+56 possible varied colours of each side	bevelled on each side	ceiling mounting on rails
ART		large-format wall panels	soft	sound absorption 0,80*	56 mm	56 bottom MDF board in black	bevelled	with use of mounting clips
AIR		overhead elements	firm	sound absorption 0,60*	40 mm	56	straight	ceiling mounting with steel wires
GLASS		glass surface panels	soft	sound absorption 0,80*	36 mm	56+56 possible varied colour of each side	bevelled on request	with use of suction cups

* In accordance with the research conducted by the accredited acoustic laboratory of the Ship Technology Institute in Gdansk, Poland. Research report available on www.fluffo.pl

** In accordance with the research conducted by the producer of the materials used for manufacturing Fluffo IZO. Research report available on www.fluffo.pl

All Fluffo collections share the same characteristics: elegant design and excellent sound absorption properties. Our products are available in many complex shapes, sizes and colours. Velvety Fluffo finish is soft and sensuous to the touch creating a comfortable and discreet mood in the interior. Go on, cuddle up! Need more information about our collections – go to www.fluffo.pl



Fluffo SOFT
Soft wall panels



Fluffo IZO
Sound insulating panels



Fluffo Wallcoverings
Soft, acoustic, felt wallcoverings



Fluffo FIRE-RESIST
Fire retardant office wall panels



Fluffo AIR
Overhead panels



Fluffo GLASS
Glass surface panels



Fluffo WEB
Acoustic curtains



Fluffo ART
Large-format wall panels

Fluffo SOFT

Sound absorbing soft wall panels

- **3D** panels
- **Flat** panels
- **Edge** – flat panels with bevelled edges
- **Rift** – flat panels with corrugated surface

Fluffo SOFT is a collection of decorative, sound absorbing wall panels, available in a wide selection of colours, shapes and thicknesses. They soundproof a room in a beautiful and stylish way. With Fluffo SOFT you can enjoy a cosy, quiet and most importantly, beautiful interior.

Go on, get to work!

MATERIAL

1. Fluffo finish 1 mm
2. Polyurethane foam

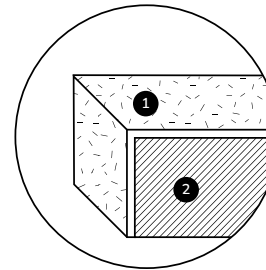

ACOUSTICS

α_s , Sound absorption coefficient according to PN-EN ISO 354:2005

125 Hz	250 Hz	500 Hz	1000 Hz	2000 Hz	4000 Hz
0.25	0.50	0.80	0.95	1.00	1.20

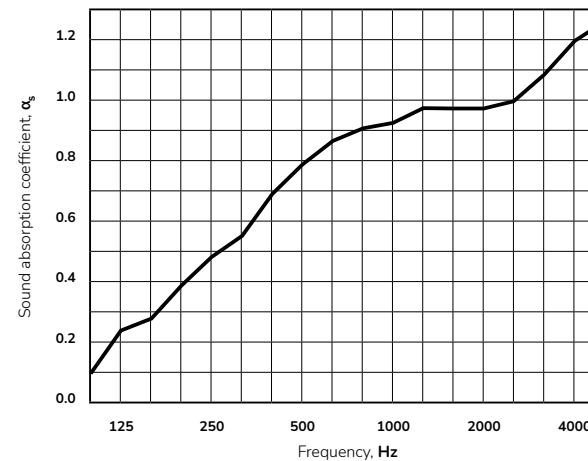

Sound absorption indicator according to PN-EN ISO 11654:1997 $\alpha_w = 0,80$

Sound absorption class: B







Fluffo SOFT 3D

3D panels

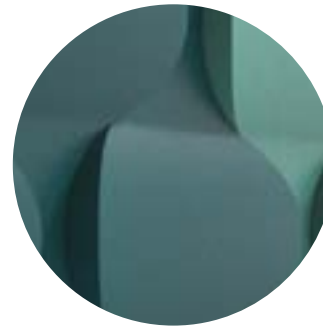

3D

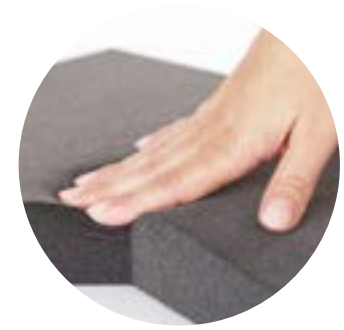

soft

model	Chevron	Chain	Flow	Link	Cube	Cubic
shape						
dimensions (mm)						
thickness	3D (varied thickness from 20 to 50 mm)					
surface area	0,10 m ²	0,13 m ²	0,11 m ²	0,18 m ²	0,25 m ²	0,06 m ²
pcs/~m ²	10 pcs/1,01 m ²	7 pcs/0,94 m ²	9 pcs/0,97 m ²	6 pcs/1,05 m ²	4 pcs/1,00 m ²	16 pcs/1,00 m ²

Fluffo SOFT

Flat panels

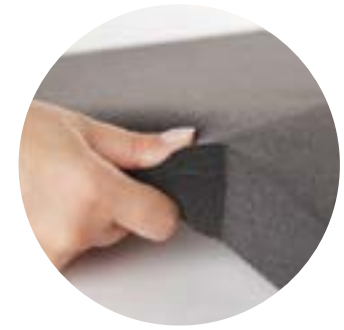
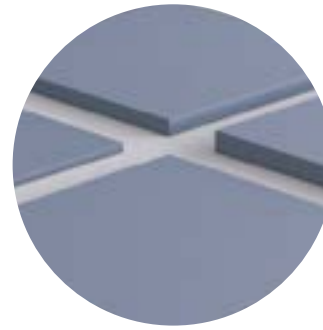

4 thicknesses:
20/30/40/50 mm

soft

model	Pixel L	Pixel M	Pixel S	Hexa L	Hexa M	Hexa S
shape						
dimensions (mm)						
thickness	20/30/40/50 mm					
surface area	0,25 m ²	0,14 m ²	0,06 m ²	0,16 m ²	0,10 m ²	0,04 m ²
pcs/~m ²	4 pcs/1,00 m ²	7 pcs/0,99 m ²	16 pcs/1,01 m ²	6 pcs/0,97 m ²	10 pcs/1,04 m ²	24 pcs/0,98 m ²







Fluffo SOFT

Flat panels



model	Tele L	Tele L	Tele S	Tele Cut L *	Tele Cut M *	Tele Cut S *
shape						
dimensions (mm)						
thickness	20/30/40/50 mm					
surface area	~ 0,25 m ²	~0,14 m ²	~0,06 m ²	0,19 m ²	0,10 m ²	0,04 m ²
pcs/~m ²	4 pcs/~ 1,00 m ²	7 pcs/~0,98 m ²	16 pcs/~1,00 m ²	5 pcs/ 0,93 m ²	10 pcs/1,03 m ²	22 pcs/0,98 m ²

* Tele Cut complements the Tele model

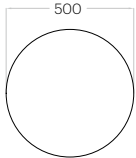
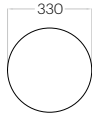
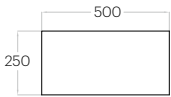
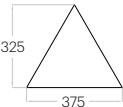
model	Dot L	Dot M	Line	Triada
shape				
dimensions (mm)				
thickness	20/30/40/50 mm			
surface area	0,20 m ²	0,09 m ²	0,13 m ²	0,06 m ²
pcs/~m ²	5 pcs/0,98 m ²	12 pcs/1,03 m ²	8 pcs/1,00 m ²	16 pcs/0,97 m ²





Fluffo SOFT EDGE

Flat panels with bevelled edges

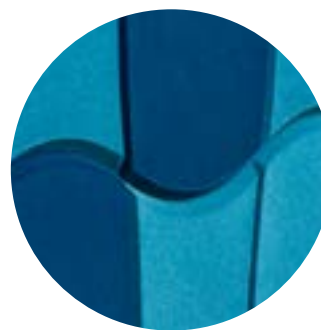

bevelled edge











soft

model	Pixel Edge L	Pixel Edge M	Pixel Edge S	Dot Edge M	Tele Edge M	Hexa Edge M
shape						
dimensions (mm)						
thickness	30 mm					
surface area	0,25 m ²	0,14 m ²	0,06 m ²	0,09 m ²	0,06 m ²	0,10 m ²
pcs/~m ²	4 pcs/1,00 m ²	7 pcs/0,99 m ²	16 pcs/1,01 m ²	12 szt/1,03 m ²	16 pcs/1,00 m ²	10 pcs/1,04 m ²

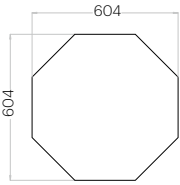
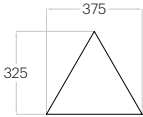
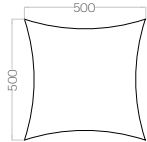
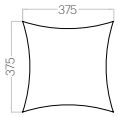
Fluffo SOFT EDGE

Flat panels with bevelled edges



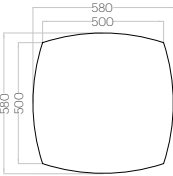
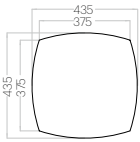
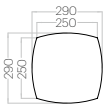

model	Octa Edge	Triada Edge	Echo Edge L	Echo Edge M	Echo Edge S
shape					
dimensions (mm)					
thickness	30 mm				
surface area	0,30 m ²	0,06 m ²	0,20 m ²	0,11 m ²	0,05 m ²
pcs/~m ²	3 pcs/0,91 m ²	16 pcs/0,97 m ²	5 pcs/1,00 m ²	9 pcs/0,99 m ²	20 pcs/1,00 m ²

model	Hello Edge L	Hello Edge M	Hello Edge S
shape			
dimensions (mm)			
thickness	30 mm		
surface area	0,30 m ²	0,17 m ²	0,08 m ²
pcs/~m ²	3 pcs/0,90 m ²	5 pcs/0,85 m ²	12 pcs/0,96 m ²

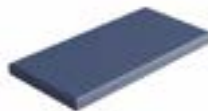

Fluffo SOFT EDGE

Flat panels with bevelled edges

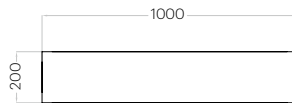
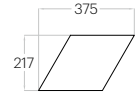
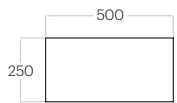
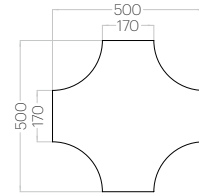
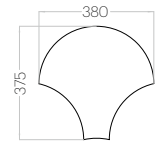
model	Stick Edge	Diamond Edge	Line Edge	Bond Edge	Shell Edge
shape					
dimensions (mm)					
thickness	30 mm				
surface area	0,20 m ²	0,05 m ²	0,13 m ²	0,16 m ²	0,09 m ²
pcs/~m ²	5 pcs/1,00 m ²	18 pcs/0,97 m ²	8 pcs/1,00 m ²	6 pcs/0,96 m ²	11 pcs/0,99 m ²

Fluffo SOFT RIFT



Flat panels with corrugated surface



corrugated surface

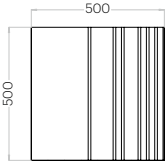
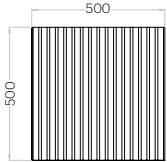
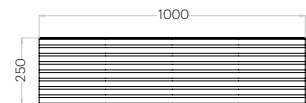

soft

model	Pixel SemiRift L	Pixel Rift L	Grand Rift
shape			
dimensions (mm)			
thickness	30 mm		
surface area	0,25 m ²	0,25 m ²	0,25 m ²
pcs/~m ²	4 pcs/1,00 m ²	4 pcs/1,00 m ²	4 pcs/1,00 m ²



Fluffo IZO

Sound insulating panels

Fluffo IZO will decorate the interior and at the same time insulate the room from exterior sound sources. Panels built from layers of specially selected materials absorb sound and constitute a sound barrier, which works both ways: they do not let sound into or out of the room.

They are an ideal solution when you have a loud neighbour behind a thin wall. Dividing walls transmit sound between two offices, or you want to hold a private conference and you want your conversations to stay within your four walls.

Create a beautiful, quiet interior with Fluffo IZO.

MATERIAL

1. Fluffo finish (1 mm)
2. Sound absorbent polyurethane foam
3. High density rubber (2 mm)
4. Open-cell flexible, foamed rubber

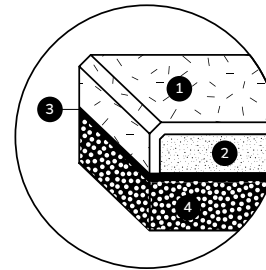

ACOUSTICS

R_w , Sound insulation according to ISO 140-3

125 Hz	250 Hz	500 Hz	1000 Hz	2000 Hz	4000 Hz
18.7	22.3	20.9	28.1	37.2	47.7

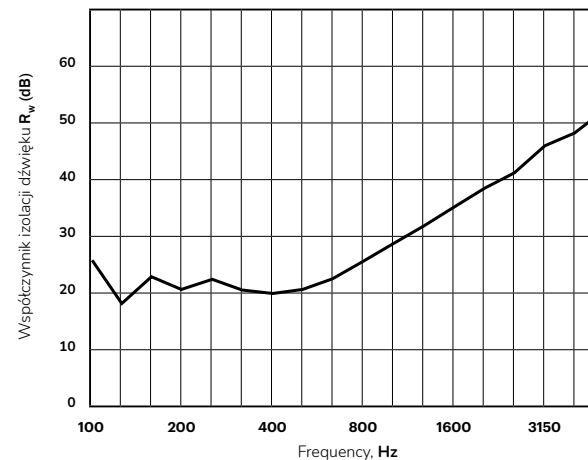

Sound insulation according to
ISO 140-3* $R_w (C; C_{tr}) = 27 (0; -2)$ dB

*Research carried out by the base material producer according to ISO 140-3 and ISO 717-1 norms.





Fluffo IZO

Sound insulating panels

Fluffo Izo is constructed from 3 layers:

first is the Fluffo Soft panel, covered with the Fluffo finish. Underneath this there are two rubber layers (high density rubber and foamed rubber). The whole constitutes a very effective sound insulating material.



model	Hexa Edge M	Octa Edge	Line Edge	Pixel Edge L	Pixel Edge M	Pixel Edge S
shape						
dimensions (mm)						
thickness	62 mm					
weight	990 g	2900 g	1190 g	2380 g	1340 g	590 g
surface area	0,10 m ²	0,30 m ²	0,13 m ²	0,25 m ²	0,14 m ²	0,06 m ²
pcs/~m ²	10 pcs/1,04 m ²	3 pcs/0,91 m ²	8 pcs/1,00 m ²	4 pcs/1,00 m ²	7 pcs/0,99 m ²	16 pcs/1,01 m ²

Fluffo WALLCOVERINGS

Soft, sound absorbing, felt wallcoverings

Fluffo wallcovering is very tactile and pleasant to the touch, sound absorbing high-quality wool felt with stabilizing paper backing. Wherever large surfaces intensify reverberation – staircases, hallways, high ceilinged living rooms – Fluffo acoustic wallcoverings will effectively reduce the bothersome echoes.

Fluffo Wallcoverings are a flame-retardant material according to the PN-EN 13501 standard applicable in the construction industry.



MATERIAL

1. Wool felt 3mm
2. Paper backing 0,1 mm

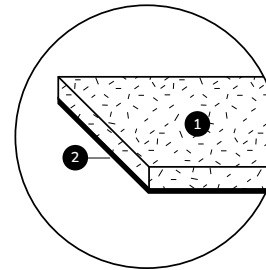

ACOUSTICS

α_w Sound absorption coefficient according to PN-EN ISO 354:2005

125 Hz	250 Hz	500 Hz	1000 Hz	2000 Hz	4000 Hz
0.02	0.01	0.03	0.12	0.29	0.47

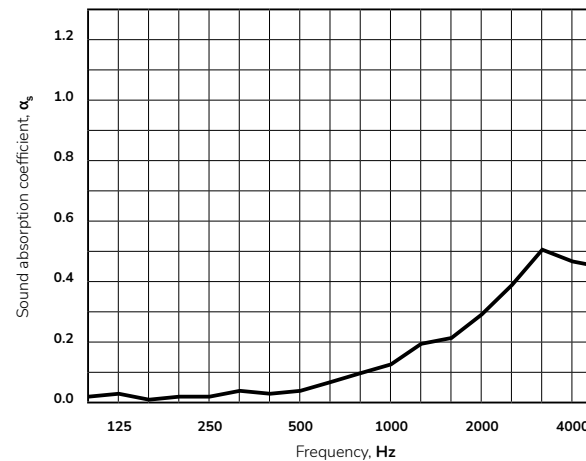

Sound absorption indicator according to PN-EN ISO 11654:1997 $\alpha_w = 0,15$

Klasa pochłaniania dźwięku: E





Fluffo WALLCOVERINGS

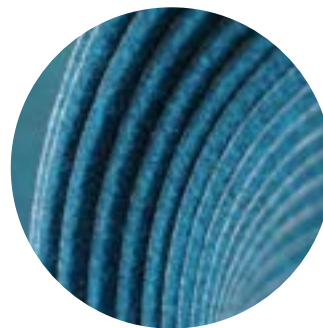

Collection name	Fluffo Wallcoverings
Available width	1425 mm*
Roll's length	Cut as ordered
Weight	550 g/m ²
Thickness	3 mm
Shrinkage	1%
Felt composition	90% wool, 10% polyester
Number of colours	20

*Due to the nature of the production technology, the width of individual production batches may vary.





Fluffo FIRE-RESIST

Fire retardant office wall panels

Fluffo FIRE-RESIST wall panels are intended for public spaces, where finishing materials must comply with the fire prevention standards **PN-EN 13501-1+A1:2010**.

Fluffo fire retardant, acoustic wall panels are available in many shapes, colours and two thicknesses, allowing the creation of unique, 3D compositions. They will work perfectly in offices, conference rooms and office telephone booths, creating safe and functional work space.



MATERIAL

1. Fluffo finish 1 mm
2. High density bio-soluble mineral wool

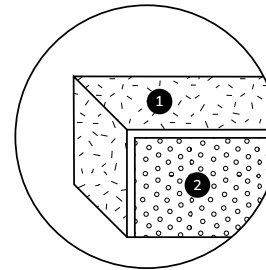

ACOUSTICS

α_w Sound absorption coefficient according to PN-EN ISO 354:2005

125 Hz	250 Hz	500 Hz	1000 Hz	2000 Hz	4000 Hz
0.15	0.25	0.60	0.90	0.85	0.80

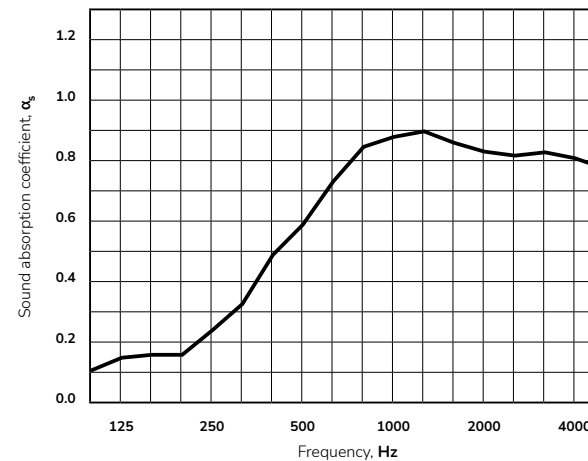

Sound absorption indicator according to PN-EN ISO 11654:1997 $\alpha_w = 0,55$

Sound absorption class: D





Fluffo FIRE-RESIST

Fire retardant office wall panels

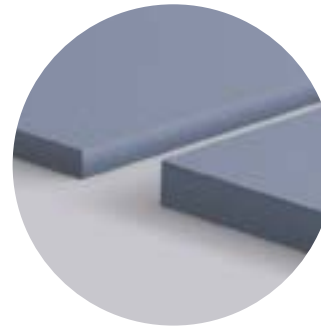

2 thicknesses:
20/30 mm









firm

model	Pixel L	Pixel M	Pixel S	Hexa L	Hexa M	Hexa S
shape						
dimensions (mm)						
thickness	20/30 mm					
surface area	0,25 m ²	0,14 m ²	0,06 m ²	0,16 m ²	0,10 m ²	0,04 m ²
pcs/~m ²	4 pcs/1,00 m ²	7 pcs/0,99 m ²	16 pcs/1,01 m ²	6 pcs/0,97 m ²	10 pcs/1,04 m ²	24 pcs/0,98 m ²

Fluffo FIRE-RESIST

Fire retardant office wall panels

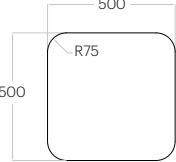
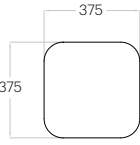
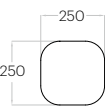
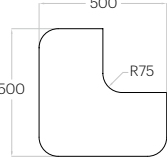
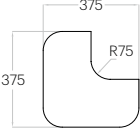
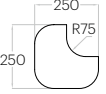







model	Tele L	Tele M	Tele S	Tele Cut L *	Tele Cut M *	Tele Cut S *
shape						
dimensions (mm)						
thickness	20/30 mm					
surface area	0,25 m ²	0,14 m ²	0,06 m ²	0,19 m ²	0,10 m ²	0,04 m ²
pcs/~m ²	4 pcs/~ 1,00 m ²	7 pcs/~0,98 m ²	16 pcs/~1,00 m ²	5 pcs/ 0,93 m ²	10 pcs/1,03 m ²	22 pcs/0,98 m ²

*Tele Cut complements the Tele model.

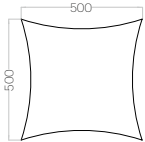
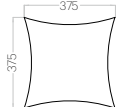

Fluffo FIRE-RESIST

Fire retardant office wall panels

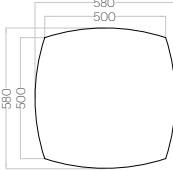
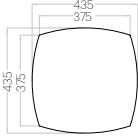
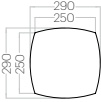
model	Echo L	Echo M	Echo S	Hello L	Hello M	Hello S
shape						
dimensions (mm)						
thickness	20/30 mm					
surface area	0,18 m ²	0,11 m ²	0,05 m ²	0,27 m ²	0,17 m ²	0,08 m ²
pcs/~m ²	6 pcs/1,06 m ²	9 pcs/0,99 m ²	20 pcs/0,98 m ²	4 pcs/1,09 m ²	6 pcs/1,02m ²	13 pcs/0,98 m ²

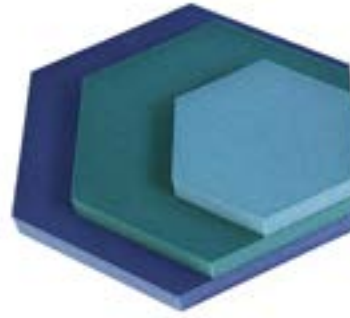

model	Bond	Shell	Triada	Line	Dot L	Dot M
shape						
dimensions (mm)						
thickness	20/30 mm					
surface area	0,16 m ²	0,09 m ²	0,06 m ²	0,13 m ²	0,20 m ²	0,09 m ²
pcs/~m ²	6 pcs/0,96 m ²	11 pcs/0,99 m ²	16 pcs/0,97 m ²	8 pcs/1,00 m ²	5 pcs/0,98 m ²	12 pcs/1,03 m ²

Fluffo WEB

Acoustic curtains

Fluffo WEB acoustic curtains serve several purposes: they effectively absorb sound, visually divide space and constitute a unique decorative element. They are a great solution for those interiors where the installation of other acoustic materials is limited.

Thanks to their openwork form and lightweight, they subtly divide space, and their colour and shape build the right ambience of the interior. The curtain can be mobile thanks to the specially designed rail.

MATERIAL

1. Fluffo finish 1 mm
2. Polyurethane foam
3. Strap and snap rivets mounting system

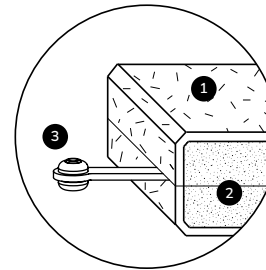

ACOUSTICS

α_w Sound absorption coefficient according to PN-EN ISO 354:2005

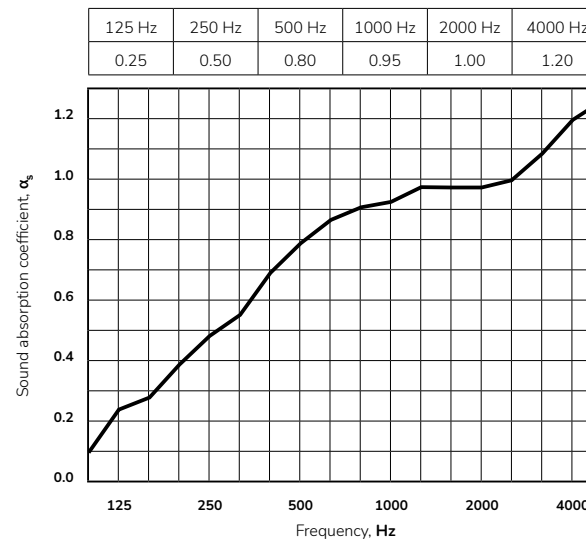

Sound absorption indicator according to PN-EN ISO 11654:1997 $\alpha_w = 0,80$

Sound absorption class: B







Fluffo WEB

Acoustic curtains







Fluffo WEB assembly is very simple. The curtain is hung on a special rail mounted to the ceiling, the panels are linked with plastic straps secured with snap rivets. Depending on the accessories used, the curtain can be mobile or fixed in place. The connecting straps between individual panels are made of a very durable plastic, resistant to tearing or cracking. A set of the necessary accessories is included with the product.



model	Pixel Edge M	Pixel Edge S	Tele Edge M	Tele Edge S	Hexa Edge M	Hexa Edge S
shape						
dimensions (mm)						
thickness	40 mm					
weight	390 g	170 g	370 g	160 g	290 g	110 g
surface area	0,14m ²	0,06 m ²	0,14 m ²	0,06 m ²	0,10 m ²	0,04 m ²

Fluffo WEB

Acoustic curtains

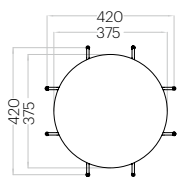
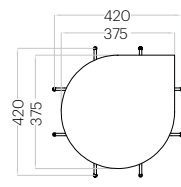
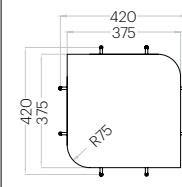
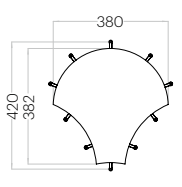
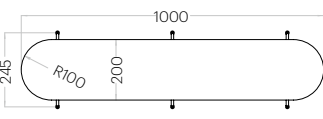
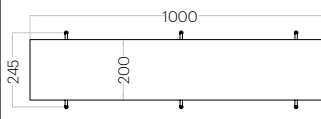
model	Dot Edge	Spot Edge	Caro Edge	Shell Edge	Bar Edge	Stick Edge
shape						
dimensions (mm)						
thickness	40 mm					
weight	300 g	330 g	380 g	250 g	530 g	550 g
surface area	0,11 m ²	0,12 m ²	0,14 m ²	0,09m ²	0,19 m ²	0,20 m ²



Fluffo ART

Large-format wall panels

Fluffo ART is a small art piece; it is the result of Fluffo's cooperation with the young Polish designer, Joanna Kabala. It is the first single large-format panel in our portfolio, available in a wide range of colours and several shapes.

It is not permanently affixed to the wall; it can be taken down and turned, or swapped with another piece of Fluffo ART, allowing the creation of a unique composition every time.

The entire collection was created with long corridors (often acoustically neglected), stair cases and large offices in mind. Where the wall needs a strong accent and the acoustics of the interior leave much to be desired.

MATERIAL

1. Fluffo finish 1 mm
2. Polyurethane foam
3. MDF
4. Mounting clips

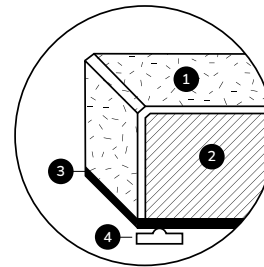

ACOUSTICS

α_w Sound absorption coefficient according to PN-EN ISO 354:2005

125 Hz	250 Hz	500 Hz	1000 Hz	2000 Hz	4000 Hz
0.25	0.50	0.80	0.95	1.00	1.20

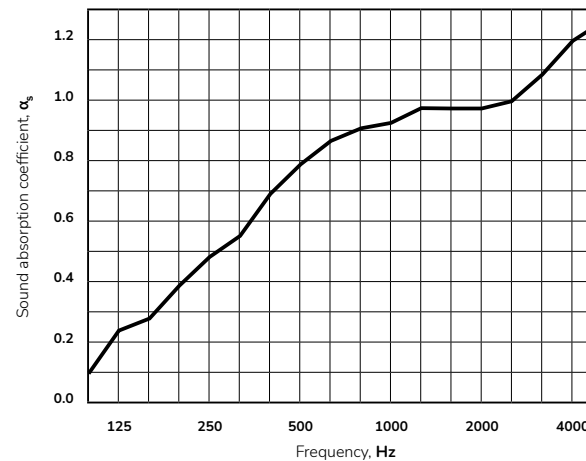

Sound absorption indicator according to PN-EN ISO 11654:1997 $\alpha_w = 0,80$

Sound absorption class: B





Fluffo ART

Large-format
wall panels

Fluffo ART panels are mounted on walls with the use of special mounting clips. This solution, allows for the panel to be repeatedly removed and reattached to the wall. The template and mounting accessories included with the product help to accurately position the mounting clips on the wall.

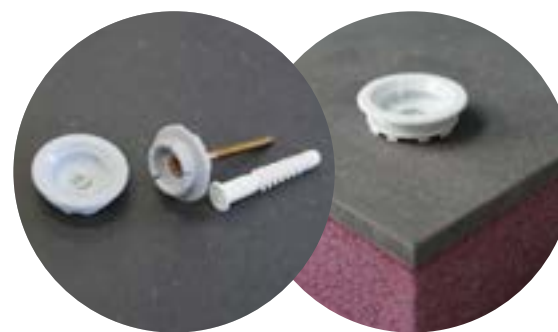

model	Art 1	Art 2	Art 3	Art 4	Art 5
shape					
dimensions (mm)					
thickness	56 mm				
weight	10000 g	8000 g	7000 g	5200 g	6800 g
surface area	1,57 m ²	1,23 m ²	1,08 m ²	0,80 m ²	1,04 m ²

Fluffo AIR

Overhead panels

Fluffo AIR – overhead panels are ideal in large spaces such as: open space offices, wide corridors, and spacious halls, where the acoustic effect of wall panels would be limited.

Fluffo AIR is available in all Fluffo colours and shapes. Fluffo AIR will bring form and colour to the spacious interiors, significantly improving their acoustics.



MATERIAL

1. Fluffo finish 1 mm
2. High density glass wool panel secured with glass fibre

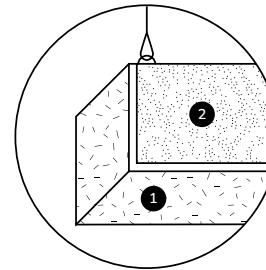

ACOUSTICS

α_w Sound absorption coefficient according to PN-EN ISO 354:2005

125 Hz	250 Hz	500 Hz	1000 Hz	2000 Hz	4000 Hz
0.13	0.30	0.62	0.74	0.59	0.54

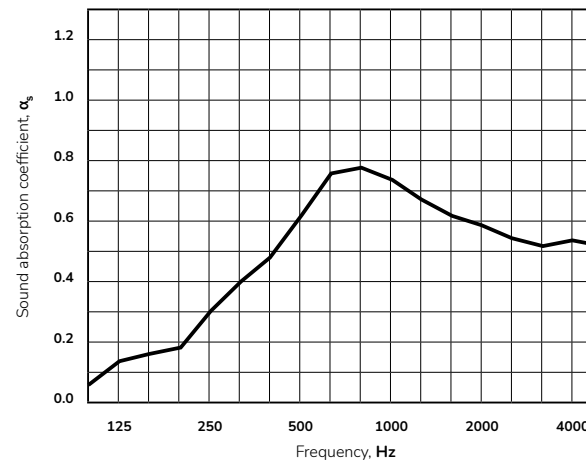

Sound absorption indicator according to PN-EN ISO 11654:1997 $\alpha_w = 0,60$

Sound absorption class: C



Fluffo Air

Overhead panels

The panel is suspended from the ceiling with **steel cables**, which make it possible for the panels to be hung at various heights. Available accessories permit the installation of panels on concrete ceilings as well as suspended raster ceilings. A set of necessary accessories and assembly templates are included with the product.



model	Dot	Pixel	Tele	Hexa	Echo	Hello	Octa
shape							
dimensions (mm)							
thickness	40 mm						
weight	2200 g	2800 g	2800 g	1800 g	2200 g	3100 g	2300 g
surface area	0,79m ²	1,00 m ²	0,99 m ²	0,65 m ²	0,79 m ²	1,12 m ²	0,83 m ²

Fluffo GLASS

Glass surface panels

Fluffo GLASS acoustic panels with a unique suction cup mounting system for glass surface application. Wide range of colours and shapes make them the ideal, unique decoration for glass walls.

Fluffo GLASS panels absorb sound and reduce echoes within the interior, they will significantly improve the acoustics in glazed conference rooms or offices where glass windows occupy large surfaces.

MATERIAL

1. Fluffo finish 1 mm
2. Polyurethane foam
3. MDF
4. Suction cups

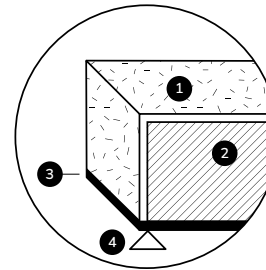

ACOUSTICS

α_w Sound absorption coefficient according to PN-EN ISO 354:2005

125 Hz	250 Hz	500 Hz	1000 Hz	2000 Hz	4000 Hz
0.25	0.50	0.80	0.95	1.00	1.20

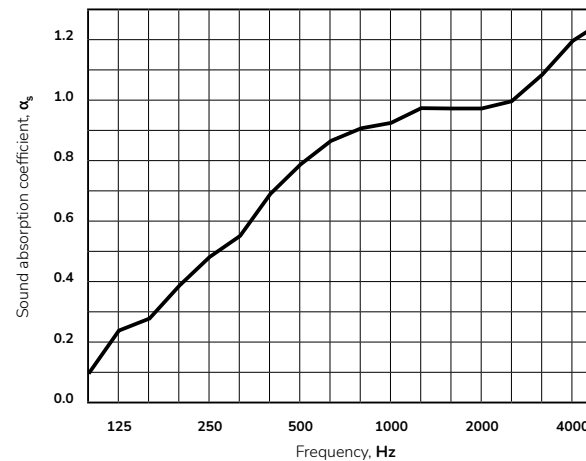

Sound absorption indicator according to PN-EN ISO 11654:1997 $\alpha_w = 0,80$

Sound absorption class: B





Fluffo Glass

Glass surface panels

Each Fluffo Glass panel is equipped with **a set of strong, transparent suction cups** (5 cm in diameter). The panel should be pressed firmly against the glass in places where the suction cups are located.

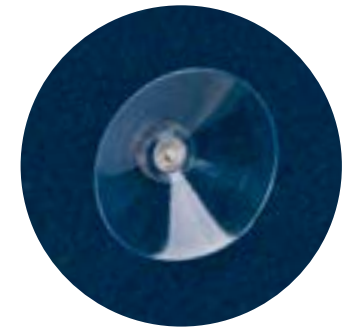

model	Pixel L	Tele L	Hexa L	Dot L
shape				
dimensions (mm)				
thickness	36 mm			
surface area	0,25 m ²	0,25 m ²	0,16 m ²	0,20 m ²
pcs/~m ²	4 pcs/1,00 m ²	4 pcs/0,98 m ²	6 pcs/0,97 m ²	5 pcs/0,98 m ²



The installation of Fluffo SOFT panels is simple, fast and clean



You can easily do it yourself and enjoy the instant effect of your work. The panels should be affixed to the wall using a flexible mounting adhesive with high initial bonding. A thin strip of the adhesive (about 5mm wide), should be applied to the outline of the panel, then simply press the panel lightly into place. After application of the adjacent panels, you can adjust their position.

You are done!

Fluffo Fix – is fool proof. It works on virtually all surfaces.

We recommend Fluffo Fix adhesive for Fluffo SOFT panel installation, it is an odourless adhesive with high initial bonding, that we have tested extensively. This adhesive has many advantages – it remains flexible for a long time allowing the adjustment of the mounted panels and has minimal shrinkage. It will glue the Fluffo SOFT panels to any surface, glass, plastic or hardboard. Fluffo Fix contains a special penetrating agent, thus there is no need for special wall preparation before panel installation. Just make sure that the surface is smooth and free of dust Fluffo Fix will hold our panels on the ceiling.

It's been tested!

Cleaning of Fluffo products is easy and efficient



The Fluffo finish covering our panels is anti-static and does not attract dust. However, dust may still settle on the panels, just like on any furniture. In order to remove dust use a brush with soft bristles or a vacuum cleaner with a standard tip for cleaning upholstered furniture.

Lightweight stains can be removed with a soft sponge slightly moistened with diluted detergent. When cleaning please wipe the whole panel surface, so that you do not leave rubbing traces in one spot. In extreme cases, where the stain has penetrated deep into the panel and is still visible despite the cleaning, the panel can be easily replaced with a new one.

Strong cleaning agents are not recommended for Fluffo panels!



Be sure not to scrub the panel surface with a wet sponge and avoid strong detergents, such as bleach or washing powder, as this might cause permanent stains on the panel surface.

FLUFFO

Invented,
designed
and produced
in Poland



Factory and office:

Wierzbín, ul. Poprzeczna 15 A
05-083 Borzęcin Duży

tel. +48 22 881 69 02 (9:00-17:00)
tel. +48 502 552 392 (24h)

email: fluffo@fluffo.pl
www.fluffo.pl

Your Fluffo representative