

MyTurn



profim



"MyTurn – distinctive, integrated, ultra relaxed. The idea was to create a range of executive seating that used a discrete unifying visual device that linked components and simultaneously formed a logical upholstery solution."

Paul Brooks
Product Designer

Comfort meets style.





Timeless design

Elegant and refined, a classic range of premium furniture including high back and low back executive chairs, a conference chair with cantilever base and complementary sofa, armchair and table.







Crafted aluminium elements and precision upholstery together with a concealed 'intelligent' mechanism.





Prestigious

The high back executive armchair blends restrained style with superior comfort. The perfect solution for a classic boardroom interior.



Distinctive

With its relaxed elegance, the conference chair is ideal for use in state-of-the-art, stylish meeting areas. Its distinguishing feature, characteristic aluminium elements are seamlessly connected with the metal frame.



Harmonious

The pieces within the range are complimentary. Each chair can stand alone or combine with other members of MyTurn family to create a unified interior space. Quilted option available throughout the range.







Classic lounge

Sofas, armchairs and coffee tables complement the executive chair range. MyTurn and MyTurn Sofas are available in leather and in a selection of upholstery fabrics, either from the standard offer or from the Creative Edition.

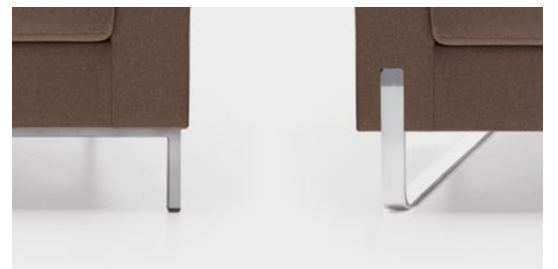

Ergonomics

A choice of two types of mechanism.



Synchro

Allowing for great flexibility thanks to its range of wide adjustment options, recommended for day-long sitting.

- ① Tilt force adjustment. The weight adjustment feature is easy and quick to use – just a few turns of the control knob covers the complete weight range.
- ② Seat height adjustment. Adjusts the height of the seat with a simple pull of the lever.
- ③ Seat/backrest tilt adjustment. A modern mechanism lockable in one of four positions.

Rocker

A discreet self-adjusting mechanism. The elegant minimal body has concealed 'intelligence' within.

- ① Seat height adjustment. Adjusts the height of the seat with a simple pull of the lever.
- ② Seat/backrest tilt adjustment (lockable in upright position). An additional forward tilt helps maintain proper back support and relieve pressure under thighs.

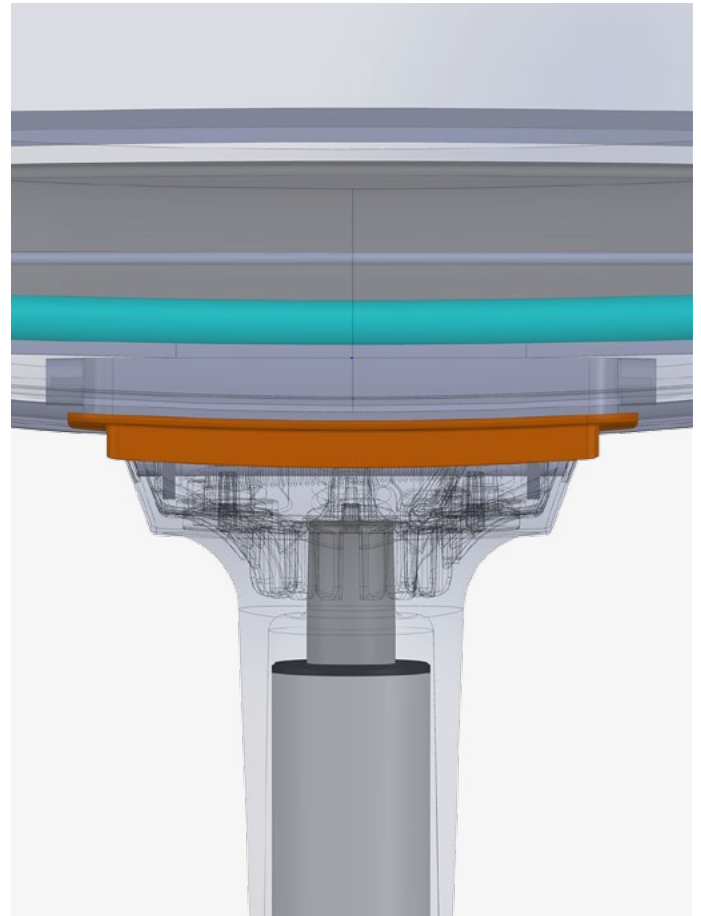
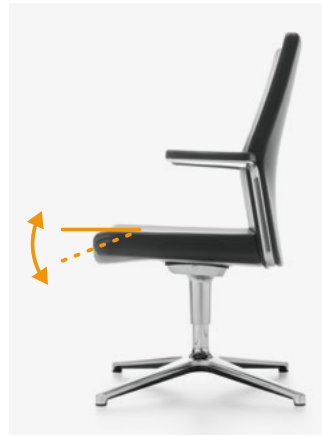

Minimalist on the outside, cutting edge on the inside.

Simplicity of form and elegant design conceal high-tech smart solutions that have undergone a series of tests before being implemented. The chair includes such features as: adjustment of chair rim under the weight of the sitting person, which enhances sitting comfort; Rocker – a mechanism designed specifically for the product and hidden inside seat, as well as discreet adjustment of the mechanism on the chair's side. Thanks to their innovative structure, the seat and the back are exceptionally flexible, and thus more comfortable.

Configure your product

When ordering, please use code symbols.

MyTurn



Backrest

Base / Mechanism / Frame



High

10



Low

20



Low (cantilever version)

21



Swivel, 5-star base
Applicable for 10, 20 versions.

S



Swivel, 4-star base
Applicable for 10, 20 versions.

F



Cantilever with stacking option
Applicable for 21 version.

V



Swivel, 5-star base with Rocker mechanism

Applicable for 10, 20 versions.

Z



Swivel, 4-star base with Rocker mechanism

Applicable for 10, 20 versions.

FZ



Cantilever without stacking option
Applicable for 21 version.

VN

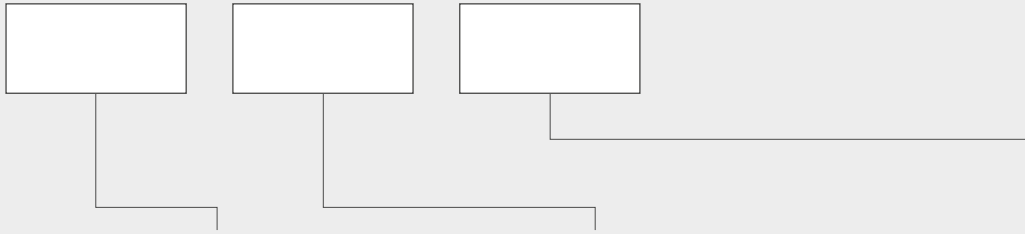

Base / frame colour



CHROME*



SATINE

Applicable for 21 version.

* Base for S, Z, F, FZ versions – polished aluminium.

Armrests



Polyurethane pad (PU)

Applicable for S, Z, F, FZ versions.

PU



Upholstery pad

Applicable for S, Z, F, FZ versions.

O



Upholstery pad

Applicable for V, VN versions.

O

Upholstery

Type & colour

SYMBOL

Additional

Castors



HARD

For soft floors.



SOFT

For hard floors.

Castors are equipped with a brake that prevents the chair from "moving away" without a load.
Applicable for S, Z, versions.

Gaslift with memory
without height adjustment
Standard applicable for F, FZ versions.



Configure your product

When ordering, please use code symbols.

MyTurn Sofa



Seat

Frame



Armchair

10



2-seat sofa

20



3-seat sofa

30

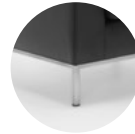

Legs

H



Cantilever

V

MyTurn Sofa Table



Type of table

Frame



Large

(1200 x 300 x 850 mm)

S1



Small

(850 x 300 x 850 mm)

S2



Legs

H

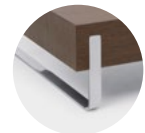





Cantilever

V



Frame colour

Upholstery

 BLACK	 CHROME
 METALLIC	 SATINE





Type & colour

SYMBOL





Frame colour





Table top

 BLACK	 CHROME
 METALLIC	 SATINE

Laminate HPL

 LW01 White	 LW04 Grey
 LW02 Black	

Modified veneer

 HM10 Bleached oak	 HM12 Cardinal oak	 HM30 Teak
 HM11 Classic oak	 HM20 Wenge classic	

Measurements

The measurements are approximate and can differ depending on the product configuration.
 Measuring methodology is available at this link: www.profim.eu/Measuring_methodology.pdf

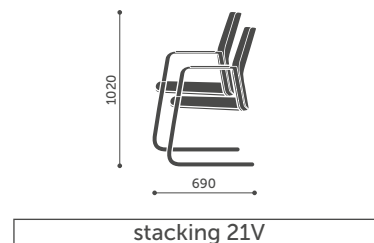
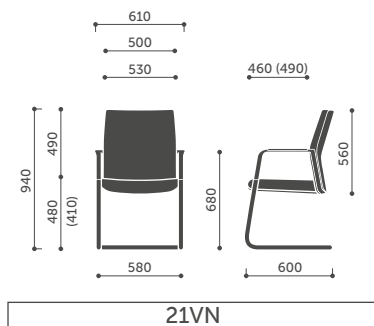
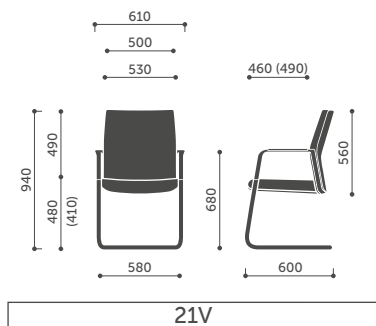
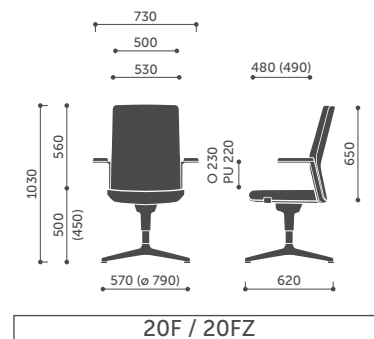
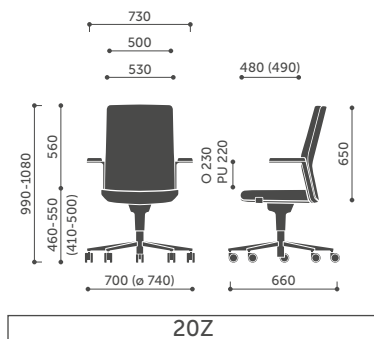
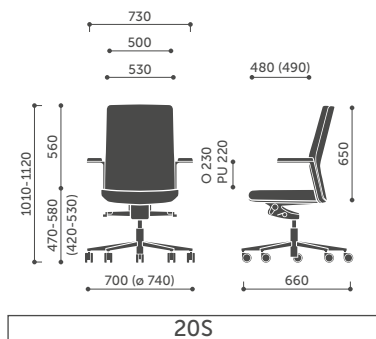
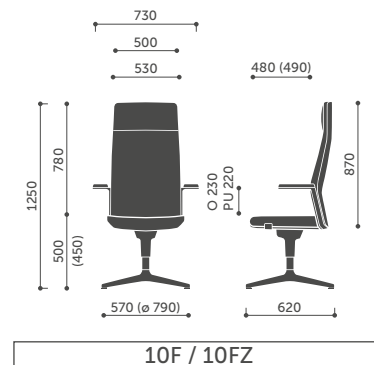
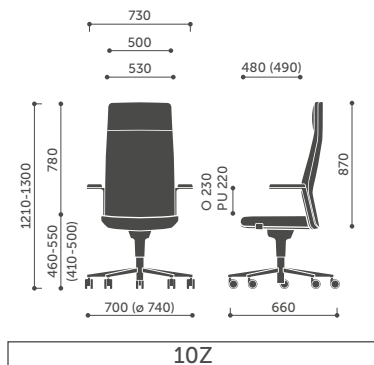
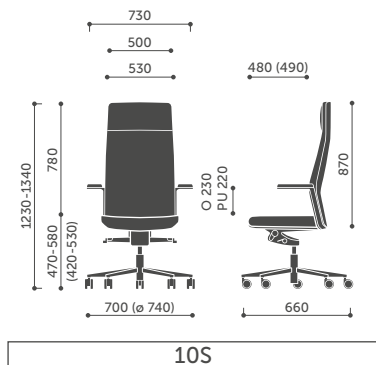

* Seat height is measured according to PN EN 16139 norm (with seat burden).



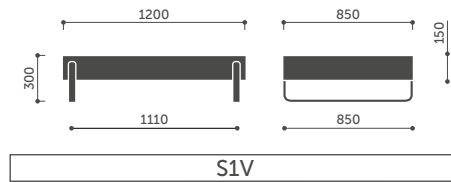
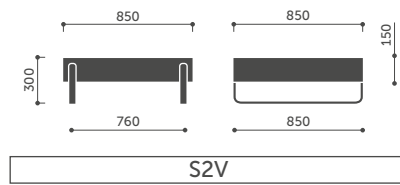
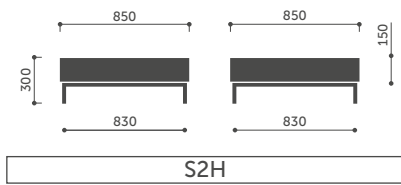
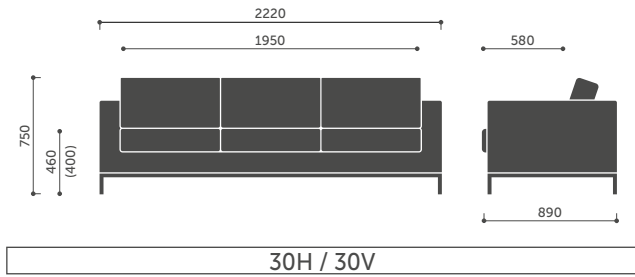
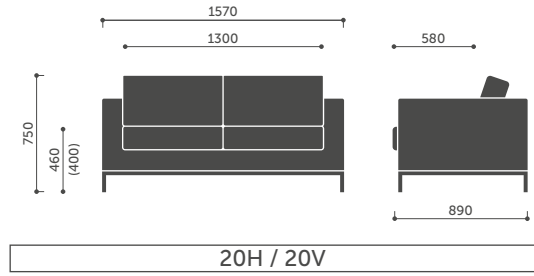
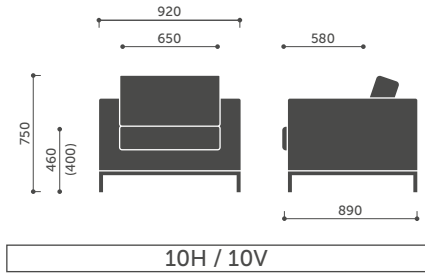

Profim and the Environment

In our operation we follow the sustainability principle. We operate in a responsible manner for the benefit of our customers, employees, suppliers, and the local community, but we always respect the environment.

In order to achieve our goals, we have implemented Environmental Management System based on the ISO 14001 standard, which allows for a comprehensive approach to ecology. We take into consideration and evaluate the way MyTurn products affect the environment during their entire life cycle.

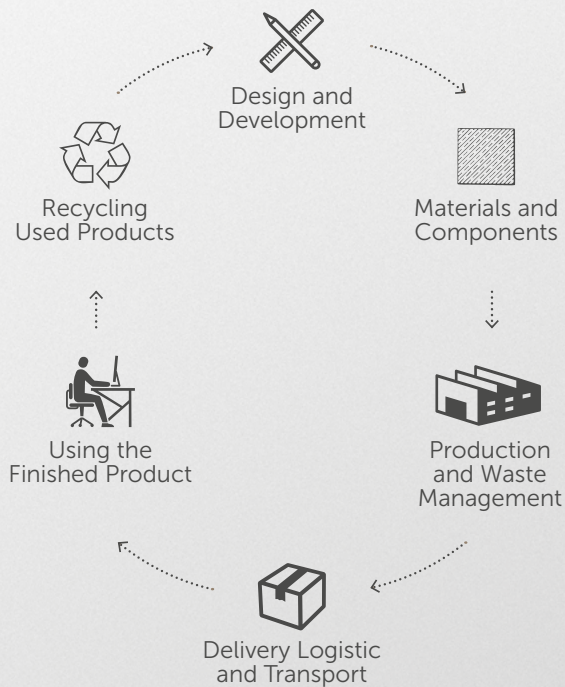

For more information about the product please scan the QR code.

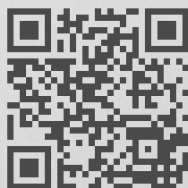

MyTurn

Product Environmental Information

(for MyTurn 20FZ)

Materials used:

Metals	kg	%
Steel	11,25	52,69
Aluminium	5,55	26,00
Plastics	kg	%
ABS	0,25	1,17
Polypropylene (PP)	0,35	1,64
PA6	0,15	0,70
Wood	kg	%
Hardboard	0,15	0,70
Others	kg	%
Upholstery	1,10	5,15
PU Foam	2,55	11,94
Weight	21,35	100

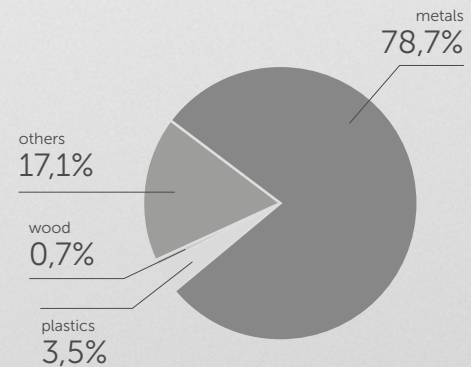

This product contains no chemical compounds harmful to human health or the environment (including PVC, chromium (VI), mercury or lead).

www.profim.eu

The producer reserves the right to conduct construction changes and improvements of the products.
Colours presented in the catalogue may vary from the original colours of furniture.



CHROMIUM (III)
Eco-Friendly Technology

CHROM (III)
Umweltfreundliche
Technologie

