

Meeting tables Ogi W technical specification



.mdd

.mdd has a leading position among manufacturers of office furniture with many awards that prove quality and continuously increase demand for it's products.

The realities of today`s market require constant quality improvement at all levels of modern organization. This applies in particular to customer service, marketing, quality of products and also to quality of processes within the company.

Partnership relations among employees and with business partners form a base of economic growth and success of the company.

Constant investments in innovative machinery park, optimization of management systems and an expansion of production halls allow to minimize the lead times for the product of the highest quality.

More than twenty years of experience in office furniture industry come with reference from a long list of companies and institutions to show their appreciation for an efficient and comprehensive service. .mdd is highly aware of the environment.

Being located in the forest region with lake by it's side, .mdd takes the nature seriously and invests constantly in a modern and energy-efficient solutions to preserve the local life. Company puts emphasis on waste segregation and recycling. .mdd has been awarded for the exceptional care and involvement in waste disposal. All materials used are environmentally friendly and enjoy a high 95 % rate of being recycled.



General informations:

Warranty:

.mdd products - **5 years.**

Electrical components and fabric - **2 years.**

Certificate - MFC:



Compliant with standards:

PN-EN 15372:2010

Boards density:

12 mm - 690 - 750 kg/m³

18 mm - 650 - 690 kg/m³

28 mm - 610 - 630 kg/m³

36 mm - 610 - 630 kg/m³

Assembly:

product delivered in separate elements

Packing:

cardboard, perforated plastic mesh wrap

Meeting tables Ogi W	Date of preparation 04.05.2022	The data contained in this document is valid in the day of its preparation. Change of the product, as long as it does not affect the basic features of it, does not require consistent updates of the document.	page 2/7 general informations
-----------------------------	-----------------------------------	---	---

Conference tables Ogi W

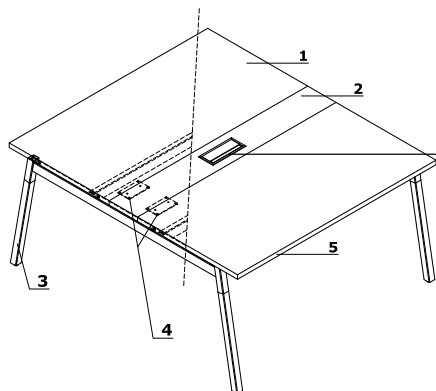

1. **Worktop** - MFC 28 mm, ABS edge
2. **MFC element** - without mediabox as standard
3. **Natural wood** - ash, with metal element, powder coated, coated with transparent varnish, profile 40 × 40 mm, spacer 10 mm between top and frame
4. **Fixing flat bar**
OPTIONS WITH EXTRA CHARGE:
 5. **Worktop edge** - colour: ash natural
 6. **Top access M05**
 7. **Mediabox M04H** - 2xRJ45 (class E, cat. 6); +1 x USB + 1 x HDMI + 4x 230V
 8. **Mediabox M04** - 2xRJ45 (class E, cat. 6); +1 x USB + 4x 230V
 9. **Mediabox M06H** - OPTION WITH ADDITIONAL CHARGE - 2x230V+HDMI+USB, colour: anodised aluminium, white, black

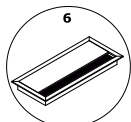

2 x RJ45
1 x HDMI
1 x USB

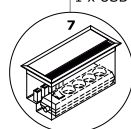

2 x RJ45
1 x USB

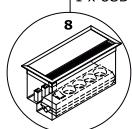

1 x HDMI
1 x USB

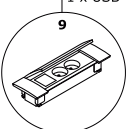

Tables

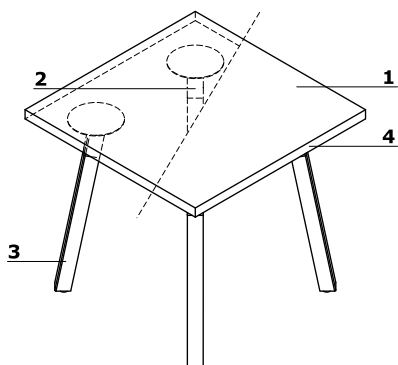

1. **Top** - MFC 18 mm, black, ABS edges 2 mm
2. **Metal element** - powder coated
3. **Frame** - metal frame , profile 40 × 40 mm, wooden leg - ash natural
OPTIONS WITH EXTRA CHARGE:
 4. **Worktop edge** - colour: ash natural

Conference tables - Ogi W *

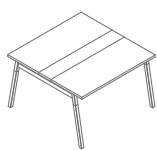

SW22
1200 / 1210 / 740
50.8 kg

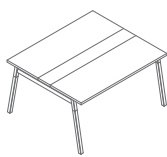

SW24
1400 / 1210 / 740
59.15 kg

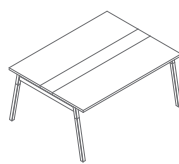

SW26
1600 / 1210 / 740
62.2 kg

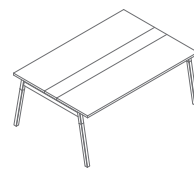

SW28
1800 / 1210 / 740
72.6 kg

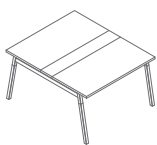

SW42
1200 / 1410 / 740
57.7 kg

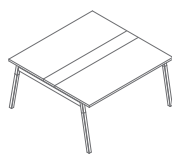

SW44
1400 / 1410 / 740
67.85 kg

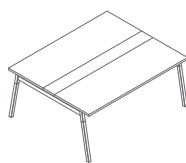

SW46
1600 / 1410 / 740
71.2 kg

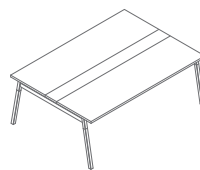

SW48
1800 / 1410 / 740
79.1 kg

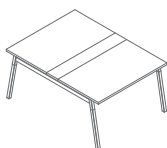

SW32
1200 / 1610 / 740
63.7 kg

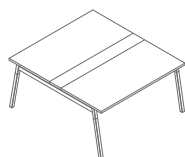

SW33
1400 / 1610 / 740
70.65 kg

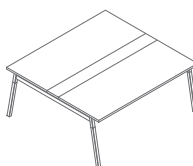

SW34
1600 / 1610 / 740
80.5 kg

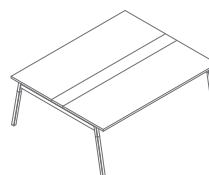

SW35
1800 / 1610 / 740
86.6 kg

* dimensions expressed in millimeters: width x depth x height

Elements for pairing - Ogi W *

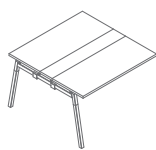

SW22L
1200 / 1210 / 740
45.6 kg

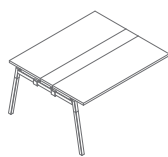

SW24L
1400 / 1210 / 740
53.95 kg

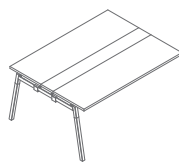

SW26L
1600 / 1210 / 740
57 kg

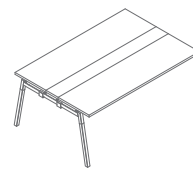

SW28L
1800 / 1210 / 740
67.4 kg

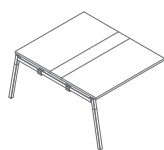

SW42L
1200 / 1410 / 740
51.9 kg

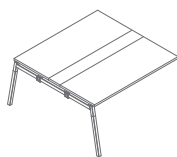

SW44L
1400 / 1410 / 740
62.05 kg

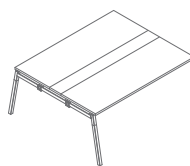

SW46L
1600 / 1410 / 740
65.4 kg

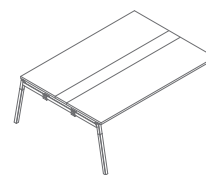

SW48L
1800 / 1410 / 740
73.3 kg

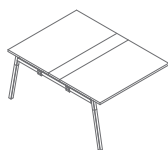

SW32L
1200 / 1610 / 740
57.5 kg

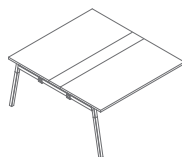

SW33L
1400 / 1610 / 740
64.45 kg

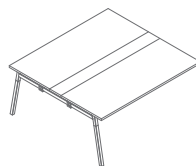

SW34L
1600 / 1610 / 740
74.3 kg

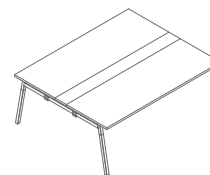

SW35L
1800 / 1610 / 740
80.4 kg

www.mdd.eu

Conference table - Ogi W *

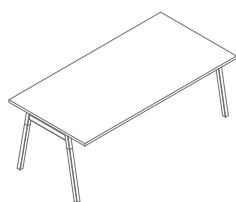

PLD20
2000 / 1000 / 740
57.8 kg

* dimensions expressed in millimeters: width x depth x height

Meeting tables Ogi W	Date of preparation 04.05.2022	The data contained in this document is valid in the day of its preparation. Change of the product, as long as it does not affect the basic features of it, does not require consistent updates of the document.	page 5/7
			products

Table - Ogi W *



PLD82
800 / 800 / 550
14.9 kg



PLD60
600 / 600 / 550
10.9 kg

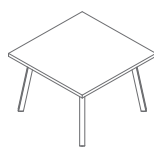

PLD83
800 / 800 / 550
18.7 kg

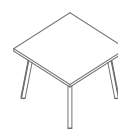

PLD61
600 / 600 / 550
13.2 kg

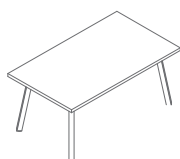

PLD17
1200 / 700 / 550
23.25 kg



PLD80
800 / 800 / 740
16.1 kg



PLD10
1000 / 1000 / 740
23.8 kg



PLD11
1200 / 1200 / 740
31.7 kg

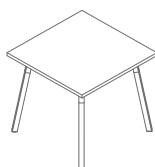

PLD81
800 / 800 / 740
20.3 kg



PLD12E
2000 / 1000 / 740
40.8 kg

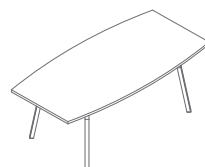

PLD12P
2000 / 800-1000 / 740
45.3 kg

* dimensions expressed in millimeters: width x depth x height

Top



Frame, mediabox

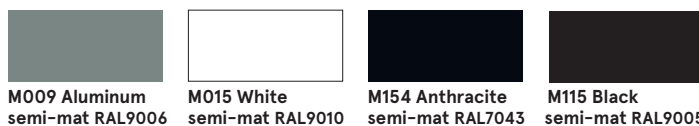

Leg



* ATTENTION - OPTION WITH EXTRA CHARGE - worktop edge, colour: ash natural