



**PLANK<sup>®</sup>**

**OUTDOOR** *collection*

Plank è un'azienda storica che ha i suoi inizi nel 1893. In linea con la filosofia aziendale volta alla ricerca, l'obiettivo di base è di indagare le possibilità tecnologiche e unirle finemente ai principi del design.

Negli ultimi anni l'azienda ha posto al centro della sua politica un forte legame con la ricerca, con la sostenibilità e con il design avvalendosi di rinomati designer come Konstantin Grcic, Naoto Fukasawa, Björn Dahlström, Ludovica + Roberto Palomba, Biagio Cisotti e Sandra Laube. La Collezione si distingue in diverse tipologie di prodotto: sedie, poltroncine, sedute lounge, sistemi di tavoli, sgabelli e complementi d'arredo. I prodotti Plank hanno ricevuto numerosi premi e riconoscimenti come il XXII Premio Compasso d'Oro ADI per la sedia MYTO e l'IF Product Design Award – Gold selection per lo sgabello MIURA e sono esposti nelle collezioni permanenti dei più importanti musei del mondo tra cui il Museum of Modern Art (MoMA) di New York, il Design Museum di Londra e l'Art Institute di Chicago.

The History of Plank begins in 1893. The basic objective has always been the investigation and intensive research for technological possibilities connected to design.

In recent years the company has placed at the center of its work a strong connection with research, sustainability and design collaborating with renowned designers such as Konstantin Grcic, Naoto Fukasawa, Björn Dahlström, Ludovica + Roberto Palomba, Biagio Cisotti and Sandra Laube. The collection has achieved distinction in a diversity of products: chairs, armchairs, lounge seating, table systems, stools. Plank products have received numerous awards and acknowledgments, for instance the XXII Compasso d'Oro ADI Design Award for the MYTO chair in addition to the IF Product Design Award – Gold selection for the MIURA stool. These products now form part of the permanent collections of some of the most important museums worldwide such as the Museum of Modern Art (MoMA) in New York, the International Design Museum in Munich, the Design Museum of London as well as the Art Institute of Chicago.

Plank ist ein traditionsreiches Unternehmen und hat seinen Ursprung im Jahre 1893. Technologie und Funktionalität, vereint durch das Design, war jeher das Ziel der Bestrebungen. Unter diesem Leitmotiv ist die Kollektion gewachsen und damit wird heute der Name Plank unverkennbar in Verbindung gebracht.

In den letzten Jahren hat das Unternehmen eine starke Verbindung zu Forschung, Nachhaltigkeit und Design in den Mittelpunkt seiner Arbeit gestellt, in Zusammenarbeit mit namhaften Designern wie Konstantin Grcic, Naoto Fukasawa, Björn Dahlström, Ludovica + Roberto Palomba, Biagio Cisotti und Sandra Laube. Die Kollektion unterscheidet sich in verschiedensten Produkt-Typologien: Stühle, Sessel, Lounge Sessel, Tischsysteme, Barhocker. Die Produkte von Plank wurden mehrfach ausgezeichnet, unter anderem mit dem XXII Compasso d'Oro ADI (MYTO chair) und dem IF Product Design Award – Gold Selection (MIURA stool) und sind in die Permanentkollektion weltweit renommierter Museen aufgenommen worden. Das Museum of Modern Art (MoMA) in New York, das Design Museum in London sowie das Art Institute in Chicago sind nur einige Beispiele.

#### Museums:

Die Neue Sammlung - The International Design Museum Munich, Germany - MoMA, The Museum of Modern Art, New York, USA - The Design Museum, Cape Town, South Africa - Musée du Québec, Québec city, Canada - Museum für Angewandte Kunst, Frankfurt, Germany - Triennale Design Museum, Milano, Italy - Kunststoffmuseum, Düsseldorf, Germany - The Art Institute of Chicago, USA - Museum für Gestaltung, Zürich, Switzerland - Deutsches Museum, München, Germany - Vitra Design Museum, Weil a. Rhein, Germany - Bröhan Design Foundation, Berlin, Germany - Denver Art Museum, USA - Badisches Landesmuseum, Karlsruhe, Germany - The Design Museum, London, Great Britain - Jerusalem Design Museum, Israel - Designsammlung Uni Wuppertal, Germany - Bergische Universität Wuppertal, Germany - Design Museum Helsinki, Finland - Indianapolis Museum of Art, USA.



## OUTDOOR *collection*

Plank è lieta di presentare una nuova raccolta di immagini lifestyle che mostrano i suoi elementi d'arredo inseriti in ambienti esterni.

Le nuove immagini sono fonte d'ispirazione per designer, architetti e altri professionisti del settore, ma anche per l'utente stesso, alla ricerca di prestigiosi elementi d'arredo per esterni da inserire nei loro progetti. Contestualizzare i prodotti nell'ambiente enfatizza i caratteri funzionali che li rendono così adatti all'uso esterno, come per esempio la superficie traforata della sedia MYTO che lascia passare l'acqua e il meccanismo pieghevole del tavolo MIURA, che permette di impilare più tavoli quando non in uso.

Plank is pleased to present a collection of new lifestyle images showing its contemporary furniture in outdoor use.

The new images offer inspiration to designers and other industry professionals, but also for the users, seeking outstanding outdoor furniture for their latest projects. Displaying the products in context emphasises the functional features that make them so well-suited to outdoor use, such as the permeable surface of the MYTO chair that lets water drain through it, and MIURA table's folding mechanism that allows multiple tables to stack when not in use.

„Plank Outdoor Collection“ ist Titel einer neuen Fotostrecke von Plank, welche die zeitlosen Möbel im Aussenbereich interpretiert.

Die Fotografien sollen Inspirationsquelle für Designer, Architekten und Branchenfachleute aber auch für den Anwender selbst sein, die auf der Suche nach herausragenden Outdoor Möbeln für Ihre Projekte sind. Die kontextbezogene Darstellung der Produkte im Freien betont Ihre funktionalen Eigenschaften – wie z.B. die perforierte Oberfläche des MYTO Freischwingers, welche das Abfließen von Wasser ermöglicht oder der MIURA Klapptisch-Mechanismus, der es ermöglicht, mehrere Tische ineinander zu reihen, wenn diese sich gerade nicht in Gebrauch befinden.

## contents

**Sedie/Poltroncine**  
**Chairs/Armchairs**  
**Stühle/Sessel**

04  
MYTO



**Sgabelli**  
**Stools**  
**Barhocker**

08  
MIURA



**Tavoli**  
**Tables**  
**Tische**

10  
MIURA



16  
MISTER X



18  
MONZA



# MYTO chair

design Konstantin Grcic

Sedia a sbalzo interamente prodotta in plastica nei colori nero, bianco, rosso traffico, arancio puro, giallo verde, blu chiaro. Impilabile, per uso interno ed esterno, riciclabile.

Cantilever chair entirely made of plastic in black, white, traffic red, pure orange, yellow green, light blue. Stackable, for in and outdoor use, recyclable.

Freischwinger Stuhl aus Kunststoff in den Farben schwarz, weiss, verkehrsrot, reinorange, gelbgrün, hellblau. Stapelbar, für Innen- und Außenbereich, recyclebar.

## Riconoscimenti / Awards / Auszeichnungen:

- ICFF Editors Awards Multiple Production, 2008
- iF Product Design Award, 2009
- Interior Innovation Award Imm Cologne, 2009 - Best of the Best Category Best Item and Materials Innovation
- Brit Insurance Design Award, 2009 - Best of category Furniture
- Australian International Design Award, 2009 - Best of Furniture Design
- XXII Premio Compasso d'Oro ADI, 2011

## Collezioni / Collections / Kollektionen:

- Die Neue Sammlung - The International Design Museum / Pinakothek der Moderne, München, Germany
- MoMA - The Museum of Modern Art, New York, USA
- Art Institute of Chicago, USA
- Deutsches Museum, München, Germany
- Kunststoffmuseum Düsseldorf, Germany
- Bröhan Design Foundation, Berlin, Germany
- Vitra Design Museum, Weil a. Rhein, Germany
- Badisches Landesmuseum, Karlsruhe, Germany
- The Design Museum, London, Great Britain
- Jerusalem Design Museum, Israel
- Designsammlung Uni Wuppertal, Germany
- Bergische Universität Wuppertal, Germany
- Design Museum Helsinki, Finland
- Indianapolis Museum of Art, USA

## Publicazioni / Publications / Publikationen:

- MYTO print documentary by Meirè e Meirè

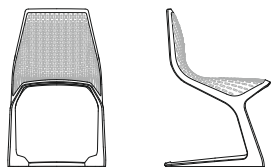



# MIURA stool

design Konstantin Grcic

Sgabello in polipropilene nei colori nero, bianco, arancio puro, rosso traffico, rosso vino, azzurro, giallo verde. Impilabile. Uso interno ed esterno, riciclabile.

Stool made of polypropylene available in black, white, pure orange, traffic red, wine red, light blue, yellow green. Stackable. Indoor and outdoor use, recyclable.

Barhocker aus Polypropylen in den Farben schwarz, weiß, reinorange, verkehrsröt, weinrot, hellblau, gelbgrün. Stapelbar. Innen- und Außenbereich, recyclebar.

## Riconoscimenti / Awards / Auszeichnungen:

- 100% Design Blueprint Best Product Award 2005
- Interior Innovation Award imm Cologne 2006 - Best of the Best in Category Best Item
- Red Dot: Product Design Award Winner 2006
- IF Product Design Award 2006 – Gold selection
- Design Award of the Federal Republic of Germany 2007, - Silver Award

## Collezioni / Collections / Kollektionen:

- Die Neue Sammlung - The International Design Museum / Pinakothek der Moderne, München, Germany
- Museum für Gestaltung, Zürich, Switzerland
- MoMA – The Museum of Modern Art, New York, USA
- Art Institute of Chicago, USA
- Triennale Design Museum, Milano, Italy

## Pubblicazioni / Publications / Publikationen:

- MIURA stool, photographed by Florian Böhm, NYC 2006, - Plank ISBN 978-88-902728-0-6

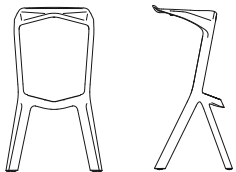

# MIURA table

design Konstantin Grcic

Sistema di tavolo pieghevole, struttura in acciaio verniciato a polvere, piani in acciaio, MDF o HPL Full color nei colori nero, bianco e rosso (solo metallo). Piano tavolo ribaltabile.

Table system, structure in powder coated metal, table top in metal, MDF or HPL full color in the colors black, white, red (metal only). With folding table top.

Tisch System, Gestell in pulverbeschichtetem Metall und Platte in Metall, MDF oder Vollaminat HPL in den Farben schwarz, weiß, verkehrsrot (nur Metall). Tischplatte klappbar.

Riconoscimenti / Awards / Auszeichnungen:

- Interior Innovation Award imm Cologne 2008 - Best of the Best in Category Best Detail

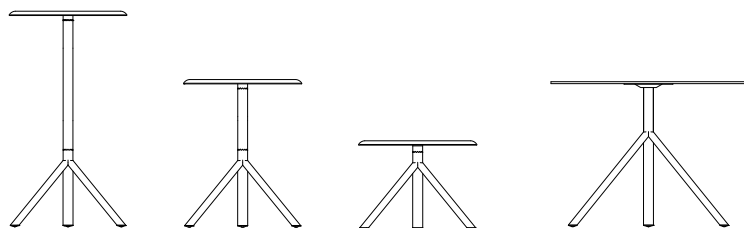











# MISTER X

design Biagio Cisotti, Sandra Laube

Tavolo. Base a quattro razze in ghisa verniciata a polvere nel colore nero o bianco. Piano tavolo in HPL Full Color o in MDF verniciato in nero o bianco. Con scivoli regolabili.

Table. Four star cast iron base black or white powder coated. Table top in high pressure laminate (HPL) Full Color or in MDF powder coated in black or white. With adjustable gliders.

Tisch. Kreuzfußgestell aus Gusseisen weiss oder schwarz pulverbeschichtet. Tischplatte aus Voll-Laminat (HPL) oder in MDF pulverbeschichtet schwarz oder weiss. Mit regulierbaren Gleitern.

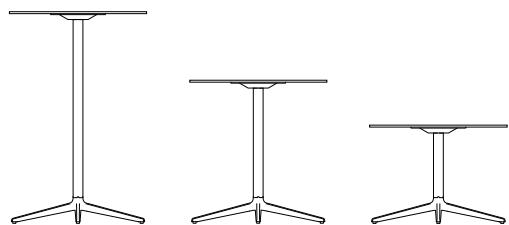

# MONZA table

design Konstantin Grcic

Sistema di tavolo, struttura in alluminio verniciata a polvere colore bianco o nero, gambe in alluminio verniciato a polvere colore bianco o nero oppure gambe in frassino verniciato naturale. Piano in laminato pieno (HPL) colore bianco o nero.

Table system, structure in aluminum white or black powder coated, legs in aluminum white or black powder coated or in ash natural lacquered. Table top in high pressure laminate (HPL) in the colors white or black.

Tisch System. Gestell aus Aluminium weiss oder schwarz pulverbeschichtet, Füße in Aluminium weiss oder schwarz pulverbeschichtet oder in Esche natur lackiert. Tischplatte aus Voll-Laminat (HPL) in den Farben schwarz oder weiss.

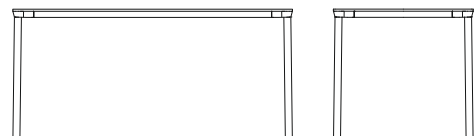

# MYTO chair design Konstantin Grcic

Mod. 1207-20

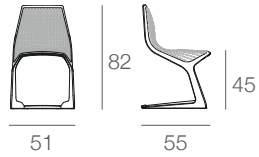

## Finiture / Finishings / Ausführungen



azzurro, light blue, hellblau



arancio puro, pure orange, reinorange



bianco, white, weiss



giallo verde, yellow green, gelbgrün



rosso segnale, traffic red, verkehrsrot



nero, black, schwarz

# MIURA stool design Konstantin Grcic

Mod. 8200-00

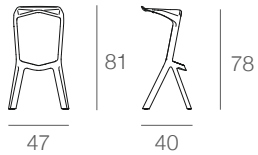

## Finiture / Finishings / Ausführungen



arancio puro, pure orange, reinorange



rosso vino, wine red, weinrot

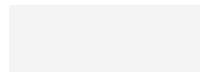

bianco, white, weiss



giallo verde, yellow green, gelbgrün



rosso traffico, traffic red, verkehrsrot



nero, black, schwarz



azzurro, light blue, hellblau

# MIURA table design Konstantin Grcic

Mod. 9553-51

Mod. 9553-01

Mod. 9553-71

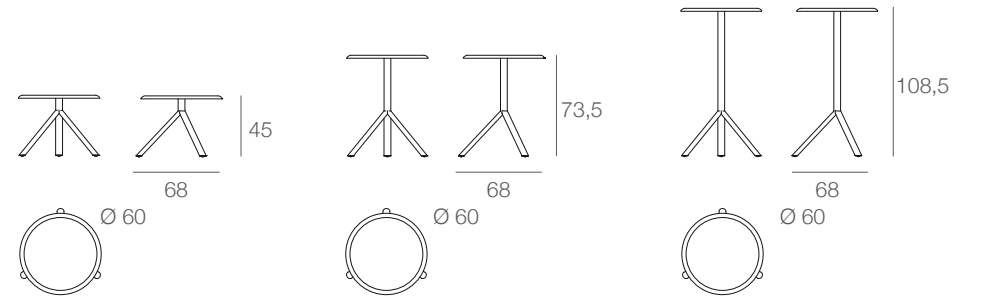

Mod. 9590-51 (Ø 70)

Mod. 9590-01 (Ø 70)

Mod. 9590-71 (Ø 70)

Mod. 9591-01 (Ø 80)

Mod. 9591-71 (Ø 80)

Mod. 9592-01 (Ø 90)

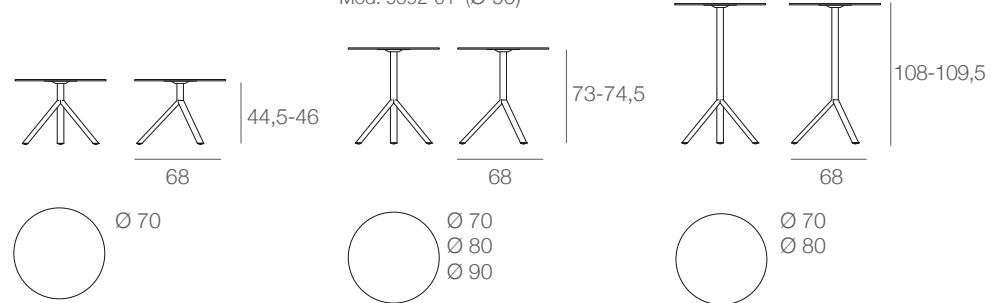

Mod. 9580-51

Mod. 9580-01

Mod. 9555-01 (Ø 100)

Mod. 9556-01 (Ø 110)

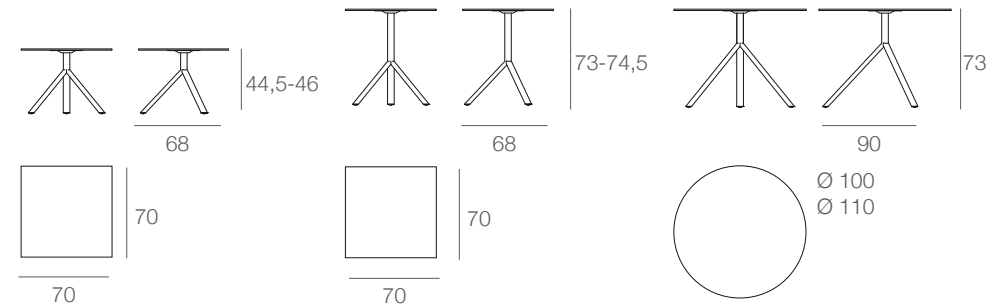

## Finiture tavolo / Table Finishings / Tischausführungen

Piano in metallo / metal table top / Metalltischplatte (Mod. 9553)

MDF verniciato / powder coated / pulverbeschichtet

HPL - Full color



nero, black, schwarz

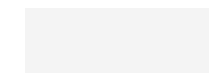

bianco, white, weiss

solo per / only for / nur für Mod. 9553



rosso traffico, traffic red, verkehrsrot

# MISTER X design Biagio Cisotti, Sandra Laube

Mod. 9506-51 (Ø 70) / Mod. 9507-51 (Ø 80)  
 Mod. 9510-51 (70x70) / Mod. 9511-50 (80x80)

Mod. 9506-01 (Ø 70) / Mod. 9507-01 (Ø 80)  
 Mod. 9510-01 (70x70) / Mod. 9511-01 (80x80)

Mod. 9506-71 (Ø 70) / Mod. 9507-71 (Ø 80)  
 Mod. 9510-71 (70x70) / Mod. 9511-71 (80x80)

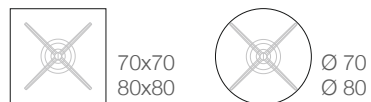
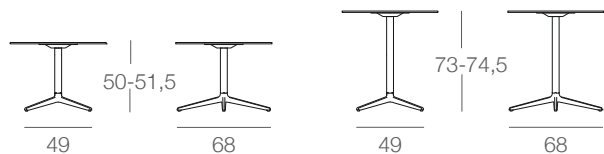

## Colori metallo / Metal colors / Metallfarben

Ghisa / Cast iron / Grauguss



nero, black, schwarz



bianco, white, weiss

## Piano tavolo / Table top / Tischplatte

MDF verniciato / powdercoated / pulverbeschichtet  
 HPL - Full color



nero, black, schwarz

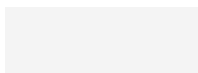

bianco, white, weiss

# MONZA table design Konstantin Grcic

Mod. 9203-01

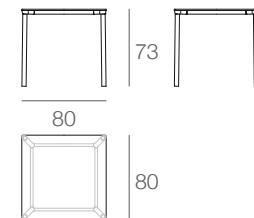

Mod. 9205-01

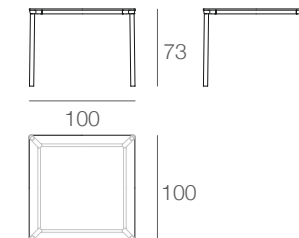

Mod. 9208-01

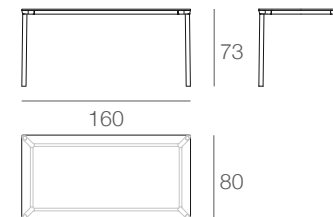

Mod. 9224-01

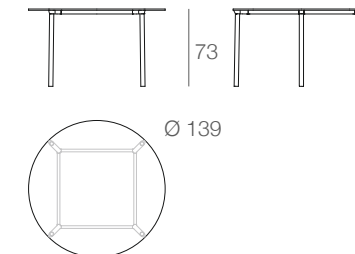

## Finiture tavolo / Table finishings / Tischausführungen



Piano tavolo: HPL, bianco  
 Struttura: alluminio, bianco  
 Gambe: alluminio, bianco

Table top: HPL, white  
 Structure: aluminium, white  
 Leg: aluminium, white

Tischplatte: HPL, weiss  
 Gestell: Aluminium, weiss  
 Füsse: Aluminium, weiss



Piano tavolo: HPL nero  
 Struttura: alluminio, nero  
 Gambe: alluminio, nero

Table top: HPL black  
 Structure: aluminium, black  
 Leg: aluminium, black

Tischplatte: HPL, schwarz  
 Gestell: Aluminium, schwarz  
 Füsse: Aluminium, schwarz

Dimensioni piani tavolo speciali su richiesta.  
Colori e verniciature speciali su richiesta  
basate sulla gamma RAL.  
Esecuzioni ignifughe (vernice, espanso su  
richiesta).

Custom table top sizes on request.  
Custom colors and finishes according to  
RAL card on request.  
Flame retardant executions (varnish, polyu-  
rethane foam) on request.

Tischplatten Sondermaße auf Anfrage.  
Sonderfarben und Lackierungen laut  
RAL-Karte auf Anfrage.  
Feuerhemmende Ausführungen (Lack,  
Schaumstoff) auf Anfrage.

© 2014 Plank Srl - International Deposit of Industrial Design  
Graphic Design: Sandra Laube Photography: Luca Meneghel  
Printed in Italy







Plank Srl, Via Nazionale 35, 39040 Ora - Italy, Tel +39 0471 803500, Fax +39 0471 803599  
e-mail: [info@plank.it](mailto:info@plank.it), [www.plank.it](http://www.plank.it)  
Quality system according to ISO 9001:2008