

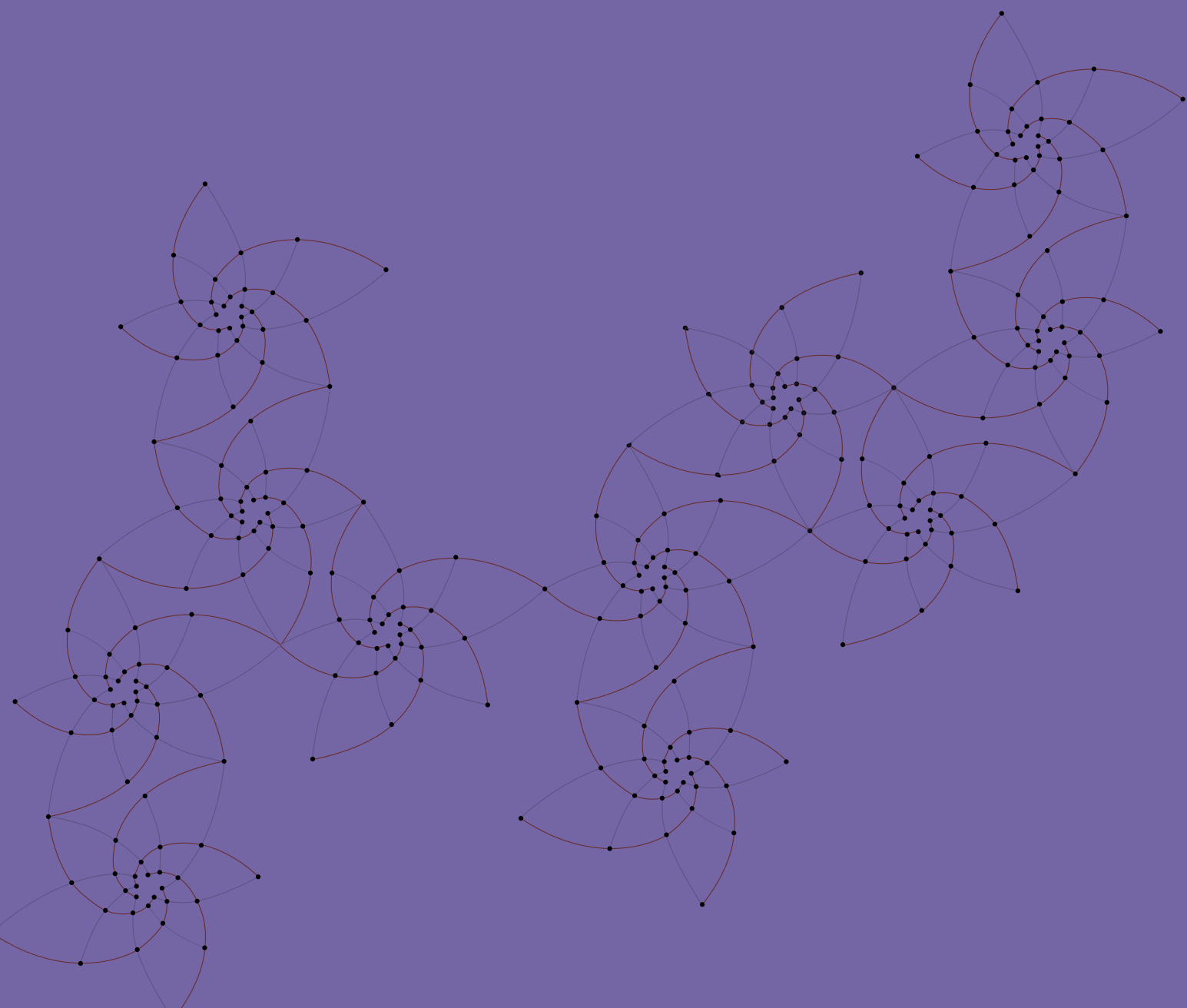

# **konoha** by toyo ito

**SANCAL** 



**toyo ito**

*No hay mejor arquitectura que la de un árbol.*

*There is no better architecture than a tree.*

*N'y a pas de meilleur architecture que celle d'un arbre.*





## Konoha, 2010.

*Paisaje vegetal con algoritmo al fondo.*

Del algoritmo de la doble espiral, por naturaleza, surge una forma única. **Toyo Ito** se ha inspirado en esta particular forma para diseñar un mobiliario que facilite el encuentro entre la gente y permita usar los espacios libremente. El resultado son unos bancos de silueta vegetal, similares a los fragmentos de una planta, con los que podemos componer una hoja completa.

Esta forma vegetal permite crear múltiples paisajes. Combinando las diferentes piezas de la serie, obtenemos diferentes ritmos. Cambiando la posición u orientación de los bancos, podemos modificar el contexto y adaptarnos a las dimensiones de cualquier espacio.

**Konoha** es una palabra japonesa que significa "hojas de árbol". En un parque encontramos hojas, bancos y esculturas, Konoha es todo ello en sólo concepto. Con o sin gente sentada en ellos, los bancos conforman un jardín interior.

*A vegetal landscape.*

From the algorithm of the double helix, there arises a unique form of Nature. **Toyo Ito** has been inspired by this particular shape to design furniture that facilitates the connection among people and that allows free use of spaces. At the same time, his desire is that the pieces generate a relaxed atmosphere and are visually evocative. The result is a bench with vegetal silhouette, similar to the fragments of a plant, with which we can compose a full leaf.

This vegetal form allows the creation of various landscapes. By combining the pieces of the series in different ways, we alter the rhythms. Changing the position or orientation of the benches, we can modify the context and adapt to the dimensions of any space.

**Konoha** is a Japanese word that means "tree leaves". In a garden we find leaves, benches and sculptures - all in one is Konoha. With or without people sitting on them, the benches create an interior garden.

*Paysage végétal avec algorithme de fond.*

De l'algorithme de la de la double spirale surgit par nature une forme unique. **Toyo Ito** s'est inspiré de cette forme particulière pour dessiner un mobilier qui facilite la rencontre entre les personnes et permet d'utiliser les espaces de façon plus libre. En même temps, son souhait est que les pièces génèrent une ambiance distendue et qu'elles soient visuellement suggestives. Le résultat est la création de bancs à la silhouette végétale, similaires aux fragments d'une plante, avec lesquels nous pouvons réaliser une feuille complète.

Cette forme végétale née de l'algorithme, permet de créer de multiples paysages. En combinant les différentes pièces de la série, nous obtenons différents rythmes. En changeant la position ou l'orientation des bancs, nous pouvons modifier le contexte et nous adapter aux dimensions de n'importe quel espace.

**Konoha** est un mot japonais qui signifie "feuilles d'arbre". Dans un parc nous rencontrons des feuilles, des bancs, et des sculptures, Konoha est tout cela en un seul concept. Avec ou sans personnes assises sur ces bancs, ceux-ci forment un jardin d'intérieur.

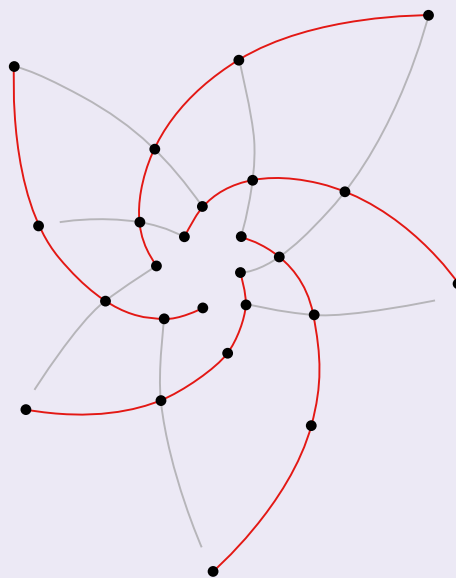
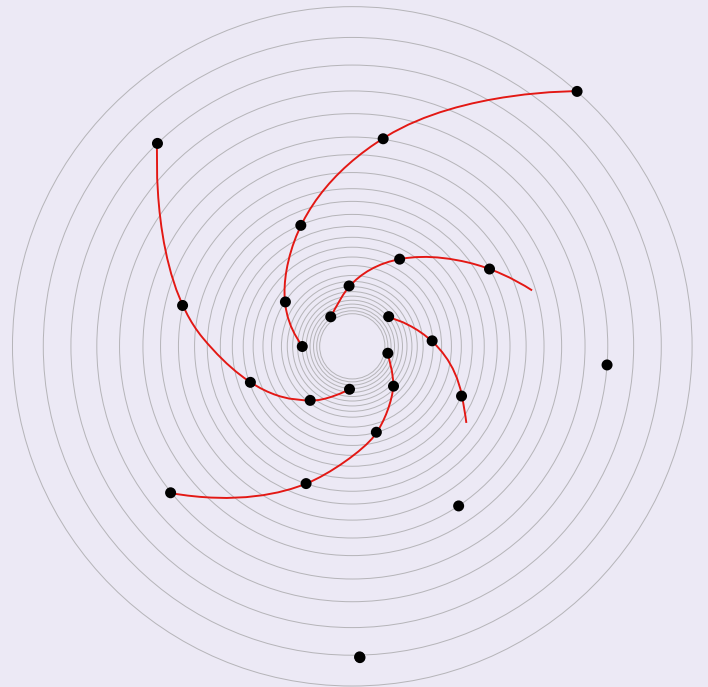

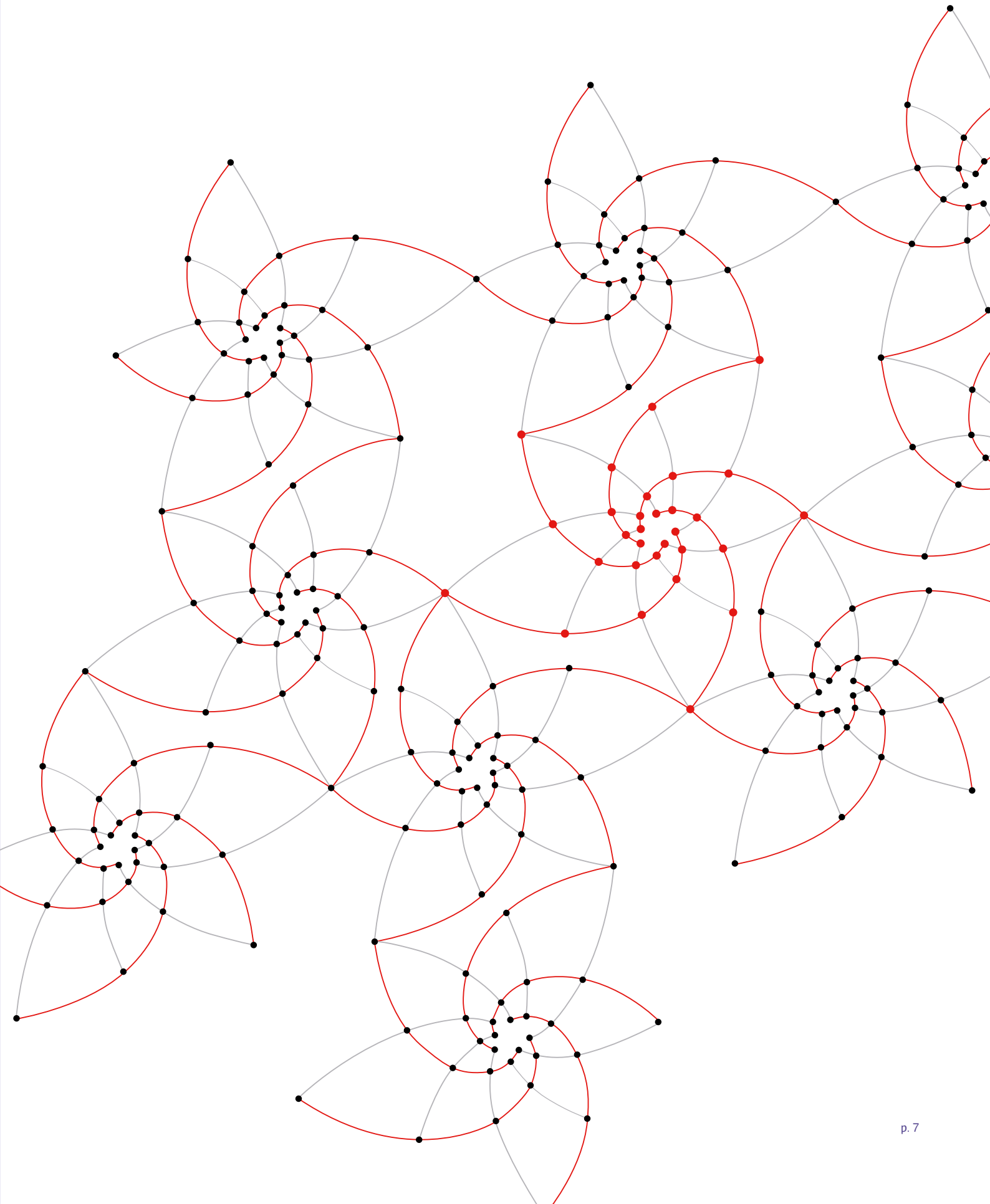



**Toyo Ito** is one of the great minds of contemporary architecture. Graduated from the University of Tokyo, Department of Architecture in 1965. In 1971, he established his own office, URBOT (Urban Robot), which was renamed to ITOAA (Toyo Ito & Associates, Architects) in 1979. From his studio based in Japan, he designs globally. Considered the “architect of nature”, Toyo Ito manages an organic architecture that applies shapes and structures found in any natural ecosystem to buildings. According to Toyo Ito “*there is no better architecture than a tree*”.

**Main works:**

Sendai Mediatheque (Miyagi, Japan) / TOD’S Omotesando Building (Tokyo, Japan) / Serpentine Gallery Pavilion (London, UK) / Hospital Cognacq-Jay (Paris, France) / The Main Stadium for the World Games (Kaohsiung, Taiwan ROC).

**Under development:**

Toyo Ito Architecture Museum (Imabari, Japan) / Extension for Fira Barcelona - Gran Via Venue (Barcelona, Spain) / Taichung Metropolitan Opera House (Taiwan ROC).

**Awards and Prizes:**

Golden Lion for Lifetime Achievement at the Venice Biennale (Italy, 2002) / Royal Gold Medal from The Royal Institute of British Architects (UK, 2006) / Frederick Kiesler Prize for Architecture and the Arts (Austria, 2008) / The 2009 Asahi Prize (2010) / Gold Medals from CBA Madrid (Spain, 2010).



**Toyo Ito, Seul 1941.**

**Toyo Ito** es una de las grandes mentes de la arquitectura contemporánea. Licenciado en Arquitectura por la Universidad de Tokio en 1965, en 1971 establece su propia oficina URBOT (Urban Robot), la cual es refundada en 1979 como ITOAA (Toyo Ito & Associates, Architects). Desde su estudio con sede central en Japón proyecta de forma global. Considerado el “arquitecto de la naturaleza”, Toyo Ito abandera una arquitectura orgánica que aplique a los edificacios formas y estructuras que podamos encontrar en cualquier ecosistema natural. Según el mismo atestigua “no hay mejor arquitectura que la de un árbol”.

**Obras más destacadas:**

Mediateca de Sendai (Miyagi, Japón) / Edificio TOD’S Omotesando (Tokio, Japón) / Pabellón de la Serpentine Gallery (Londres, Reino Unido) / Hospital Cognacq-Jay (París, Francia) / Estadio principal para los Mundiales de 2009 (Kaohsiung, Taiwán - República de China).

**En proyecto:**

Museo de Arquitectura Toyo Ito (Imabari, Japón) / Ampliación de Fira Barcelona - Recinto Gran Vía (Barcelona, España) / Taichung Metropolitan Opera House (Taichung, Taiwán - República de China).

**Premios y distinciones:**

León de Oro a su Trayectoria Profesional en la Bial de Venecia (Italia, 2002) / Medalla de Oro del Instituto Real de Arquitectos Británicos (Reino Unido, 2006) / Premio Frederick Kiesler a la Arquitectura y las Artes (Austria, 2008), Premio Asahi (2010) / Medalla de Oro del Círculo de Bellas Artes de Madrid (España, 2010).



**Toyo Ito** est l’une des grandes figures de l’architecture contemporaine. Licencié en architecture de l’Université de Tokyo en 1965, en 1971 il établit son propre bureau URBOT (URBA ROBOT) qui est consolidée dans 1979 comme ITOOA (Toyo Ito & Associates, Architects). Il travaille de façon globale depuis son étude basée au Japon. Considéré comme “l’architecte de la nature”, Toyo Ito est le porte drapeau d’une architecture organique qu’il applique aux formes d’édifices et aux structures que nous rencontrons dans tout écosystème naturel. Lui même atteste qu’il “*n’y a pas de meilleur architecture que celle d’un arbre*”.

**Oeuvres les plus remarquables:**

Médiathèque de Sendai (Miyagi, Japón) / Bâtiment TOD’S Omotesando (Tokio, Japón) / Pavillon de la serpent (Londres, Reino Unido) / L’Hôpital Cognacq-Jay (Paris, France) / Stade principal de la Coupe du Monde 2009 (Kaohsiung, Taiwán - République de Chine).

**Des projets:**

Musée d’architecture de Toyo Ito (Imabari, Japón) / Agrandissement de Fira Barcelona - Enceinte Gran Vía (Barcelona, Espagne) / Taichung Metropolitan Opera House (Taichung, Taiwán - République de Chine).

**Prix et distinctions:**

Lyon d’or a su Carrière Professionnelle en la Bial de Venecia (Italia, 2002) / Médaille d’or de lycee Real d’architectes Británicos (Reino Unido, 2006) / Prix Frederick Kiesler a l’Architecture et l’arts (Autriche, 2008), Prix Asahi (2010) / Médaille d’or del Círculo de Bellas Artes de Madrid (Espagne, 2010).





Torres Porta Fira (Barcelona, España). Konoa fue proyectada por primera vez para el hotel H Santos Porta Fira.  
Porta Fira Towers (Barcelona, Spain). Konoa was designed for the first time for the hotel H Santos Porta Fira.  
Torres Porta Fira (Barcelona, Espagne). Konoa a été projeté la première fois pour l'hôtel H Santos Porta Fira.

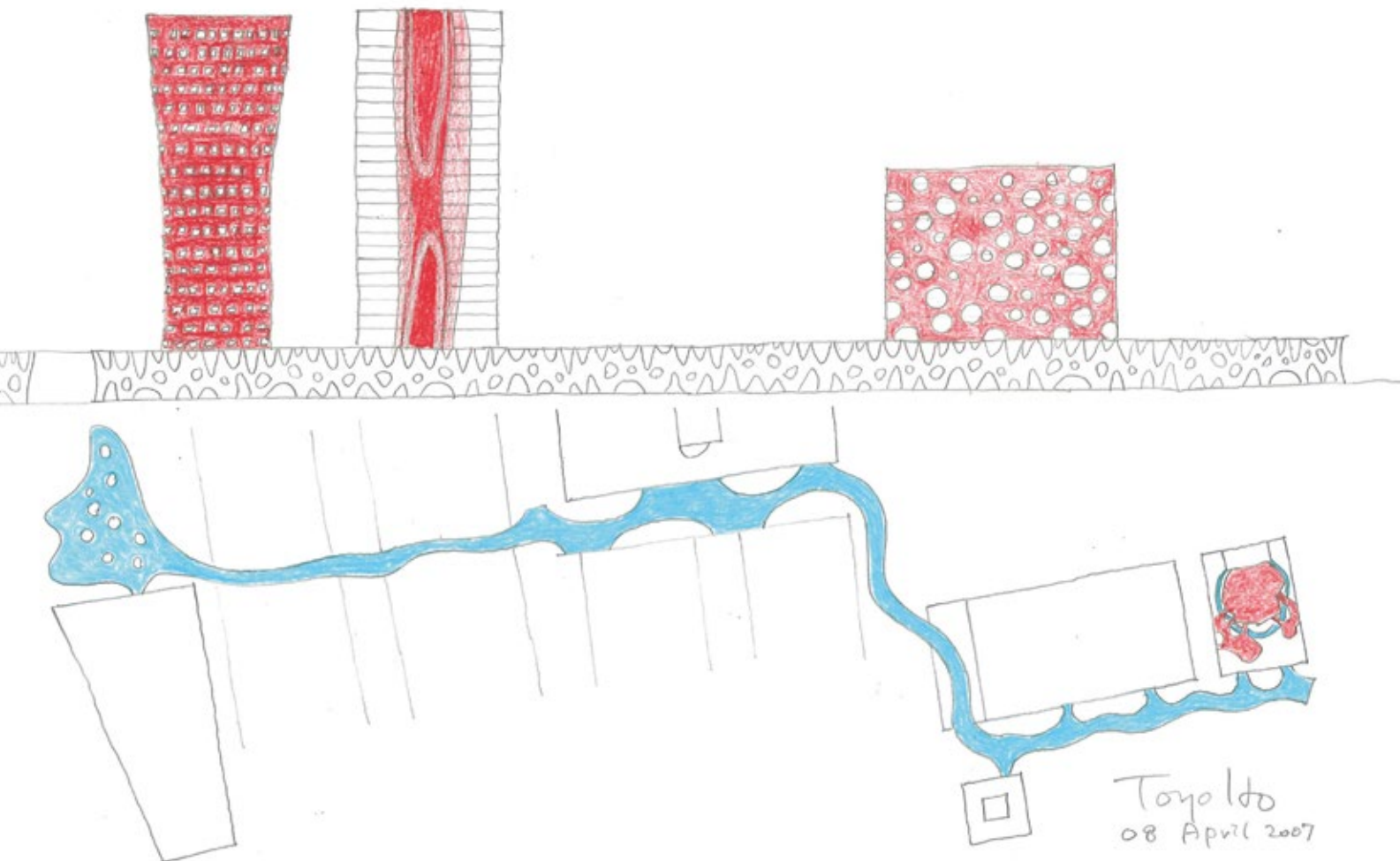

konoha the making of





















































by Toyo Ito, 2010

**Paisaje vegetal con algoritmo al fondo.**

Para los acabados, Toyo Ito apuesta por materiales nobles: lana, madera y acero con el fin de potenciar el componente orgánico del diseño.

La base es de haya blanqueada, en homenaje al envés de las hojas del álamo.

Konoha es una palabra japonesa que significa "hojas de árbol".

by Toyo Ito, 2010

**A natural landscape.**

Toyo Ito uses natural, quality materials: wool, wood and steel to enhance the organic component of the design.

The base is made of bleached beech, as the underside of the white poplar leaf.

Konoha is a Japanese word that means tree leaves.

By Toyo Ito, 2010

**Paysage végétal avec algorithme de fond.**

Pour les finitions Toyo Ito propose de matériaux nobles comme la laine, le bois, et l'acier afin d'optimiser le composant organique du dessin.

La structure est en hêtre blanchi, en hommage à l'envers des feuilles du peuplier.

Konoha est un mot japonais qui signifie "feuilles d'arbre".

**CARACTERÍSTICAS TÉCNICAS**

- Bastidor de asiento: espuma HR de 60kg y fibra HR 100 de gr.
- Asiento tapizado no desfundable.
- Estructura de haya listonada maciza. Acabado tinto en blanco al 30% para no cubrir la veta de la madera.
- Patas de acero inoxidable con regulación de altura. Acabado satinado.

**TECHNICAL CHARACTERISTICS**

- Seat structure: HR 60Kg foam, covered with HR 100gr fibre
- Fixed cover, not removable.
- Structure of solid beech wood. Transparent stained finish, 30% white allowing appreciation of the wood grain.
- Stainless steel feet with height adjustment. Satin finish.

**CARACTERISTIQUES TECHNIQUES**

- Châssis d'assise en mousse HR de 60kg et fibre HR de 100gr.
- Assise en tissu non déhoussable.
- Structure en hêtre massif. Finition teinté blanc à 30% afin de ne pas couvrir les veines du bois.
- Pieds en acier inoxydable avec réglage de la hauteur. Finition satinée.

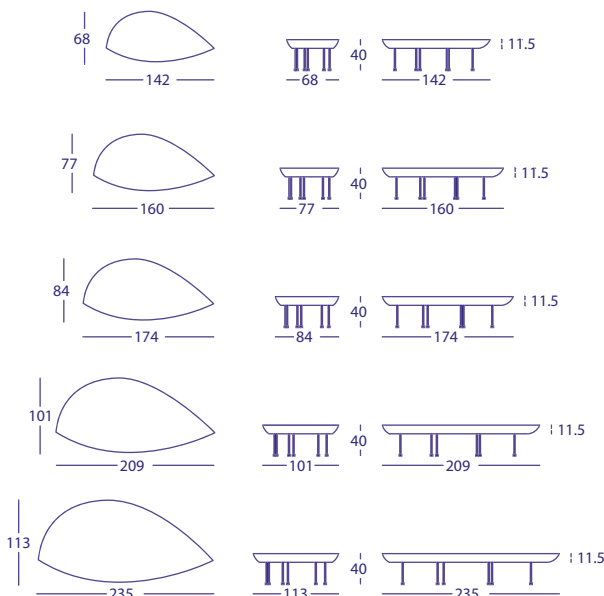

DESCRIPCIÓN / DESCRIPTION	REF.
BANCO 142X68 BENCH 142X68 BANQUETTE 142X68	259.10.QGE
BANCO 160X77 BENCH 160X77 BANQUETTE 160X77	259.10.SHE
BANCO 174X84 BENCH 174X84 BANQUETTE 174X84	259.10.TJE
BANCO 209X101 BENCH 209X101 BANQUETTE 209X101	259.10.WLE
BANCO 235X113 BENCH 235X113 BANQUETTE 235X113	259.10.ZME

## **SANCAL**

REF. 10056\_2\_konoha

Art direction & styling **juan ibañez**

Photography

**marcelo martinez, manolo santa, david frutos**

Cordination **esther castaño-lópez**

Graphic proyect **juan ibañez**

Print Lalmprenta

Copyright © Sancal Diseño S.L. 2018

### **SANCAL DISEÑO, S.L.**

Pol. Ind. La Herrada C/ Príncipe de Asturias, 18

30510 Yecla (Murcia) Spain

Tel. Esp. +34 968 75 15 03

Tel. Eng. +34 968 71 90 62

Tel. Fra. +34 968 71 90 61

Fax +34 968 79 40 62

e-mail [web@sancal.com](mailto:web@sancal.com)

[www.sancal.com](http://www.sancal.com)

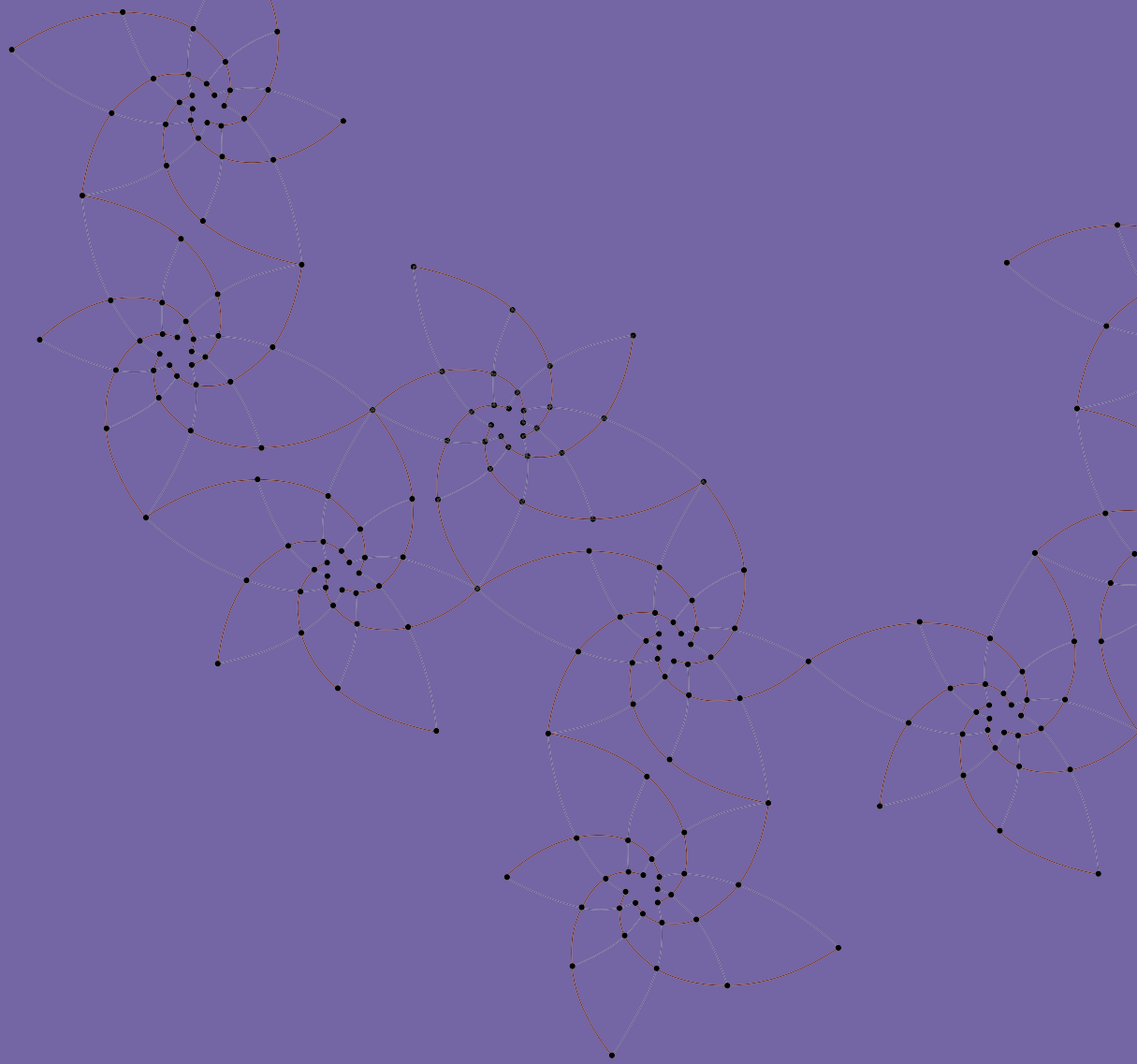

[www.sancal.com](http://www.sancal.com)

