





## **Flash Collection**

Esta colección es de 2012. Para evitar inconvenientes, revise la tarifa actual para comprobar la vigencia del producto antes de solicitarlo.

**El modelo Nudo en su versión comedor ha sido reemplazado por el Nudo Basic.**

This collection is from 2012. To avoid disappointment, please check our latest price list to see if a specific configuration is still in production before ordering.

**The Nudo dining table featured here has been replaced by the Nudo Basic.**



PARTY  
pag. 04-21



FLOAT  
pag. 22-41



COPLA  
pag. 42-57



NUDO  
pag. 58-71



## FLASH COLLECTION

### ¡Hágase la luz!

Flash no es solo el recurso fotográfico elegido para inmortalizar los nuevos productos, es también el concepto que aglutina toda la colección. Cada producto ha sido concebido de forma fulminante, cual rayo de energía.

Inspirada en la luz y las sombras, la Flash Collection es tan austera como deslumbrante. Cada una de las piezas posee un leve halo de excentricidad que las hace brillar de un modo muy particular.

Un flash de ideas para representar una colección que apuesta por diseños independientes que puedan ser proyectados en solitario y crear ambientaciones excitantes con lo mínimo.

Para la puesta en escena de la colección hemos recurrido a formas geométricas básicas y a un meticuloso uso del color. Asimismo, confiando en que la belleza está en el interior, hemos sacado a luz las entrañas de nuestros productos. Diferentes composiciones de espuma de poliuretano ambientan y se convierten en el hilo conductor de este luminoso catálogo.

## And may there be light!

Flash is not only a photographic resource chosen to capture the new products: it is also the concept that encompasses the entire collection. Each product has been designed to impact – to create a sense of energy.

Inspired by light and shadows, the Flash Collection is as austere as stunning. Each model has an air of eccentricity making them stand out in a particular way.

A flash of ideas to represent a collection that is committed to independent designs which can be projected on their own to create exciting settings with minimum items.

To stage the collection, we have turned to basic geometric shapes and a meticulous use of colours. Likewise, trusting the saying “beauty is on the inside”, we have brought the inner soul of our products to light. Different combinations in polyurethane foam set the atmosphere and become the common theme of this enlightened catalogue.

## Que la lumière soit!

Flash n'est pas seulement un moyen graphique pour immortaliser les nouveaux produits, c'est aussi un concept qui réunit toute la collection. Chaque produit a été conçu de façon explosive, avec énergie.

Inspiré de la lumière et des ombres, la Collection Flash est aussi austère qu'éblouissante. Chaque pièce possède un certain niveau d'excentricité qui la fait briller de façon assez particulière.

Un Flash d'idées pour présenter une collection qui mise sur des designs indépendants pouvant être projetés solitairement et créer avec le minimum des ambiances excitantes.

Pour la mise en scène de la collection, nous avons fait appel à des formes géométriques basiques et à une utilisation méticuleuse des couleurs. Aussi en partant du principe que la beauté est à l'intérieur, nous avons mis en lumière les entrailles de nos produits. Les différentes mousses utilisées sont le fil conducteur de ce lumineux catalogue.

PARTY  
LUIS ESLAVA STUDIO



**Luis Eslava Studio.** Tras sus estudios en el Royal College of Art de Londres, su experiencia laboral en Camper y una temporada en Japón, en 2008 Luis decide establecer su propio estudio en Valencia. Comparte la dirección creativa junto a Lorena Sauras, formada en diseño industrial entre España y Suecia y con experiencia laboral en diseño de interiores. Ambos entienden el diseño desde una perspectiva integral, para ellos, "el diseñador ha de ser capaz de aportar todo tipo de soluciones". Es por esto que orientan su estudio hacia la creación de proyectos globales y se implican con la misma pasión en todas las fases del proceso. En España colaboran con empresas como Sancal y Lzf-lamps. A nivel internacional con la japonesa Tombow, Velcro o Martini.



**Luis Eslava Studio.** After studying at the Royal College of Art in London, his working experience by Camper and a while living in Japan, Luis decided to move to Valencia in 2008 and to establish his studio there. He shares the creative management with Lorena Sauras, who trained in the Design field both in Spain and Sweden, having a great experience in interior design. They approach the definition of design from a comprehensive point of view. For them "a designer must be able to propose a wide range of solutions". This is the reason why their studio heads for global projects, while they participate in all productive stages. They collaborate with Sancal and Lzf-Lamps in Spain. At an international level, they do it with the Japanese Tombow, Velcro or Martini.

**Luis Eslava Studio.** Après ses études au Royal College of Art de Londres, son expérience chez Camper et une période au Japon en 2008, Luis décida d'ouvrir son propre bureau d'étude à Valencia. Il partage la direction créative avec Lorena Sauras, formée au Design industriel entre l'Espagne et la Suisse, avec une expérience professionnelle en design d'intérieur. Les deux conçoivent le design dans sa plus large expression. Pour eux, « le designer doit être capable d'apporter tout type de solution ». Pour cela, ils orientent leur étude vers la création de projets globaux et s'impliquent avec la même passion dans toutes les phases du processus. En Espagne, ils collaborent avec des entreprises comme Sancal et Lzf Lamps. Au niveau international, avec Tombow au Japon, Velcro ou encore Martini.



# PARTY

## ¡No te sientes, celébralo!

Party es el primer diseño que Sancal desarrolla junto al estudio de Luis Eslava, un estudio con una dilatada experiencia en el diseño de iluminación, que aborda por primera vez un proyecto de tapicería. A pesar de la novatada, el resultado es sensacional.

Bajo el lema ¡no te sientes, celébralo!, presentamos un producto modular que aporta nuevas formas de convivir alrededor del sofá. Sentarnos a distintos niveles y lanzarnos a la conquista del suelo se convierte en una experiencia novedosa porque nos permite romper barreras e interactuar fluidamente. También conseguimos ampliar las plazas de asiento en un plis-plas.

Además de su extensa modularidad y posibilidades, Party es el resultado de una cuidada y artesanal ejecución. Los detalles de confección son numerosos: el presente vivo que remarca los cambios de tejido, las dobles costuras y los botones de los mullidos cojines. También destaca la originalidad del brazo con mesita incorporada.

Las almohadas de asiento son una secreta mezcla de espuma y fibra que aporta máximo confort.

El puf de 95x95 y los módulos de 80 y 95, también están disponibles en una versión que hemos denominado *módulos con almohada*. Se trata de una versión interactiva con una almohada integrada en la estructura y otra suelta. La almohada suelta está configurada para lanzarla al suelo y ampliar las plazas de asiento de un modo informal. La base de estas almohadas portátiles está confeccionada con un tejido antideslizante y fácil de limpiar. Las plazas de asiento se pueden ampliar de nuevo acoplando los pufs con fondo 68 a la parte trasera de los respaldos, ya que los respaldos son igualmente confortables por ambos lados.

## Don't sit on it. Just enjoy it.

Party is Sancal's first model designed together with Luis Eslava. His studio is extensive experienced in the field of lighting design, being this his first upholstery introspection and reaching an amazing result.

Under the motto "Don't sit on it". Just enjoy it we are delighted to present a versatile product which offers us new ways of interacting with and around the sofa. Multiple seat heights or the floor conquest comes true with this model, breaking any established barrier.

Apart from the many possibilities and combinations, Party is the result of a careful handcrafted piece of work, which is witnessed by its production: its cord seaming, which remarks fabric changes, double seaming or the buttons sewed on its soft cushions, not to talk about its original arm, with a small table.

The seat cushions are a secret mixture of foam and fiber, maximizing comfort and durability.

The 80cm and 95cm modules together with the 95x95 pouf are also available in an interactive version called *modules with cushion*: one cushion within the structure and individual one. Why? The latter was conceived to throw it on the floor and widen the seating possibilities in an informal way. The back side of these portable cushions is manufactured with an easy-cleaning non-slip fabric. But there is more to it: Party poufs widen the seating options, due to its different sites and the comfort of the rear part of its back rests.

## Ne t'assois pas, faisons la fête!

Party est le premier modèle développé en partenariat avec le bureau d'étude de Luis Eslava, expérimenté dans le secteur du luminaire, qui aborde pour la première fois un projet de produit tapissé. Le résultat est sensationnel.

Sous le slogan : «ne t'assois pas, faisons la fête», nous présentons un produit qui apporte de nouvelles formes de convivialité autour du canapé. S'asseoir sur différents niveaux et se lancer à la conquête du sol, se traduit en une nouvelle expérience qui permet de rompre les standards et d'interagir avec fluidité. Ce programme permet aussi d'augmenter le nombre d'assises et de gagner en modularité.

En plus de sa modularité et de ses nombreuses possibilités, Party est le résultat d'une exécution attentive et artisanale. Les détails de confection sont nombreux : le passepoil visible qui souligne les jonctions de plusieurs tissus, les doubles coutures et les boutons des nombreux coussins. Le bras avec une tablette incorporée est aussi étonnant qu'astucieux.

Les coussins d'assise sont un secret mélange de mousses et de fibres qui apporte un maximum de confort.

Le pouff de 95x95 et les modules de 80 et de 95 sont aussi disponibles dans une version appelée *module avec coussin*. Il s'agit d'une version interactive avec un coussin intégré à la structure et un autre coussin nomade. Le coussin nomade est configuré pour être mis par terre et augmenter le nombre d'assises de mode informel. La partie inférieure de ces coussins nomades est confectionnée avec un tissu antidérapant et facile à nettoyer. Il est possible d'augmenter le nombre de places assises en accouplant les poufs profondeur 68 à la partie arrière de dos des modules, les dossiers ayant le même confort des 2 côtés.



PARTY 7











PARTY 12













PARTY 17







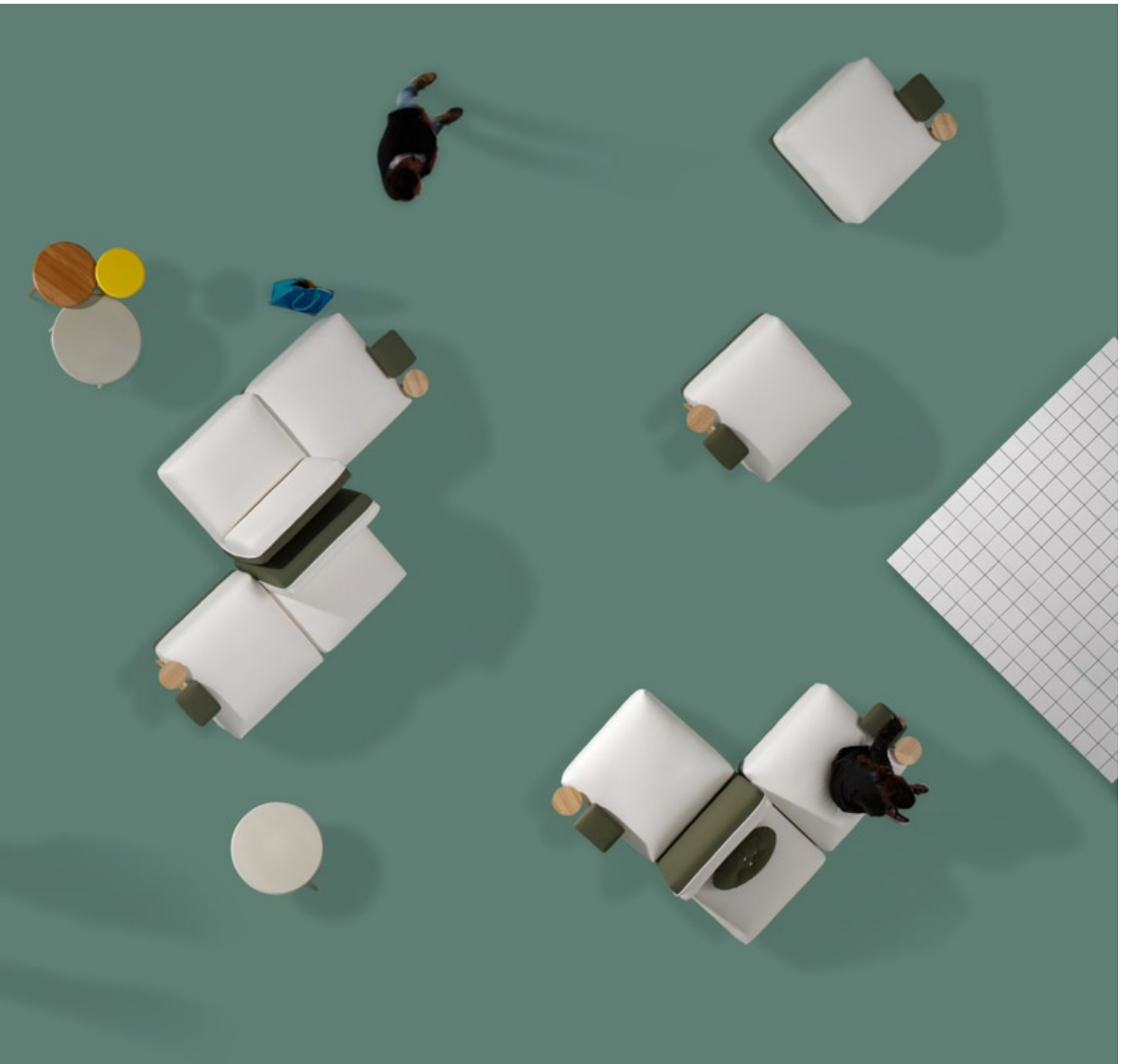



# FLOAT KARIM RASHID



**Karim Rashid** es uno de los diseñadores más prolíficos de su generación. Ganador de los prestigiosos Red Dot Design Awards en diversas ediciones, es un célebre invitado en numerosas universidades como conferenciante y ha visto publicadas diversas monografías en torno a su obra. Su pluralismo flirtea con la moda, el arte o la música, y su creatividad impregna cualquier aspecto, ya sea físico o virtual, de los paisajes contemporáneos.

Desde su estudio entre Nueva York y Ámsterdam, ha trabajado con grandes empresas de toda índole como Samsung, Soni-Ericsson, Kenzo, Hugo Boss, Veuve Clicquot, Alessi o 3M. Ha diseñado mobiliario para Bonaldo y Vondom e iluminación con Artemide. Además, la desbordante creatividad de Karim ha estado al servicio de singulares proyectos de interiorismo para la cadena de hoteles Nhow, Deutsche Bank o Audi. Float es el primer proyecto en el que Sancal colabora con su estudio.

**Karim Rashid** is one of his generation's most prolific artists. Winner of the prestigious Red Dot Design Awards on several occasions, he is a well-known visiting lecturer at a number of universities and many case studies on his work have been published. His pluralism flirts with fashion, art or music, and his creativity pervades any aspect, physical or virtual, of contemporary landscapes.

From his studio between New York and Amsterdam, he has worked with renowned companies of all kinds such as Samsung, Soni-Ericsson, Kenzo, Hugo Boss, Veuve Clicquot, Alessi or 3M. He has designed furniture for Bonaldo and Vondom and lighting with Artemide. Karim's boundless creativity has been at the service of unique interior design projects for the hotel chain Nhow, for Deutsche Bank and Audi. Float is the first project in which Sancal has collaborated with his studio.

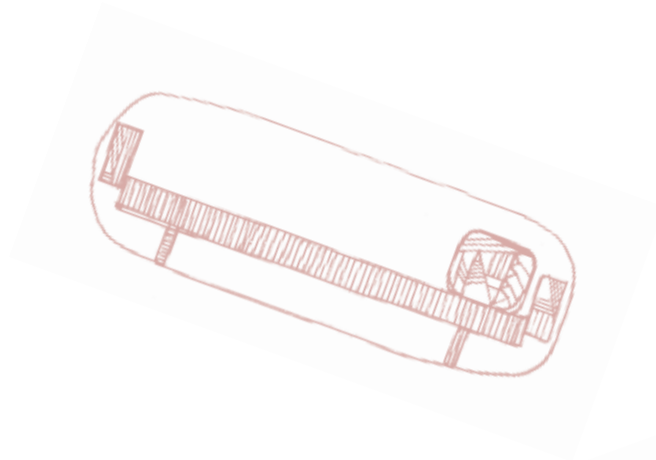

**Karim Rashid** est l'un des designers les plus prolifiques de sa génération. Plusieurs fois vainqueur des prestigieux Red Dot Design Awards, souvent invité pour des conférences dans de nombreuses universités, et ses œuvres ont souvent été publiées. Son pluralisme flirte souvent avec la mode, l'art ou la musique, et sa créativité imprègne les aspects physiques ou virtuels des paysages contemporains.

Depuis son bureau d'étude, entre New-York et Amsterdam, Karim a travaillé avec de grandes entreprises comme Samsung, Sony, Ericson, Kenzo, Hugo Boss, Veuve Cliquot, Alessi ou 3M. Il a dessiné du mobilier pour Bonaldo et Vondom, et du luminaire pour Artemide. De plus, sa créativité débordante a été mise au service de projets de décoration d'intérieure pour la chaîne d'hôtel Nhow, pour Deutsche Bank ou encore Audi. Float est le premier projet en collaboration avec Sancal.

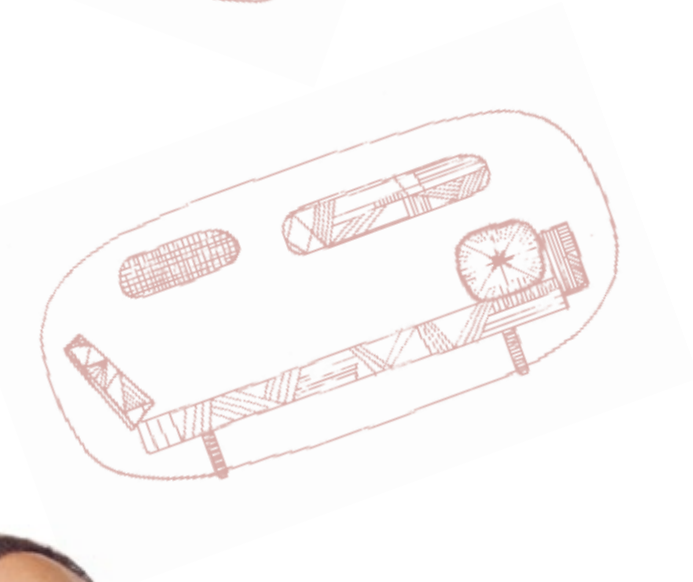

# FLOAT

## Un sofá que hace las veces de biombo

De la mano de Karim Rashid hemos conseguido crear un asiento que respeta nuestro universo propio cuando habitamos espacios públicos. Como diría Virginia Woolf, una habitación propia que nos proporciona intimidad y nos libera.

Float es un diván contemporáneo pensado para múltiples usos. Este delgado asiento flotante, con pared incorporada, nos concede total privacidad en entornos abiertos para recostarnos, colgar la bufanda y el abrigo, o simplemente esperar en el reservado que dispone su enorme respaldo.

Una de las principales características de los diseños de Karim son sus, a priori imposibles, coloridas combinaciones. Los productos Sancal son, en cambio, menos estridentes. Con Float hemos encontrado un perfecto equilibrio, puesto que concedemos mayor protagonismo a las texturas y reservamos las notas de color para pequeños detalles como los reposacabezas o los cojines.

Cada componente de Float (brazos, asiento, respaldo y reposacabezas) se puede seleccionar en un tejido distinto. También existe una versión completamente uniformada, tapizada en único tejido.

Float está disponible en 3 tamaños: dos sofás con respaldo bajo y un sofá con respaldo alto. Este último tiene distintas configuraciones; además de los brazos rectos, podemos seleccionar un brazo inclinado que sirve para recostarnos sobre él a modo de diván. Asimismo, el respaldo alto, como si de una pared se tratara, permite incorporar dos colgadores.

Para cojines y reposacabezas Karim también ha diseñado una serie de estampados denominados Cairo. La colección está inspirada en su Egipto natal. Bajo una óptica extremadamente contemporánea, Karim aúna tradición y recuerdos personales, y tiñe de luminosos colores unos dibujos de orgánica geometría.

## A sofa that is also a screen.

Hand in hand with Karim Rashid, we have managed to create a seat that respects our own universe when we cohabit in public spaces. As Virginia Woolf would say, a room of one's own providing intimacy and freedom.

Float is a contemporary couch designed for multiple purposes. This slim floating seat with incorporated back wall provides complete privacy in open spaces, to rest back on, hang one's scarf or coat on or simply wait in the secluded area given by its high back.

One of the main characteristics of Karim's designs is their colourful combinations, which at first sight seem not possible. Sancal products, on the other hand, are less vibrant. Float offers the perfect balance, as we have granted greater relevance to the textures and reserved the touches of colour for smaller detail such as the headrest or cushions.

Each Float component (arms, seat, back and headrest) can be selected in a different fabric. There is also a single colour option, upholstered with the same fabric.

Float is available in 3 sizes: two sofas with a low back and one sofa with a high back. The latter offers different combinations: apart from the straight arms, you can choose an inclined arm to lie back on like a divan. Furthermore, two hangers can be attached to the high back as if as it were a wall.

As for the cushions and headrests, Karim has also designed a series of patterns named Cairo. The collection is inspired in Egypt, where he was born. With a strong contemporary approach, Karim unites tradition and personal memories, adding bright colours to pictures of organic geometry.

## Une chambre à soi.

Karim Rashid a réussi à dessiner un modèle de canapé qui respecte notre propre univers lorsque nous aménageons des espaces publics. Comme aurait dit Virginia Woolf, «une chambre à soi» qui nous procure intimité et nous libère.

Float est un divan contemporain pensé pour de multiples utilisations. Cette mince assise flottante avec dossier mural incorporé, nous confère un espace privatisé dans un environnement ouvert pour nous allonger, déposer nos affaires, ou encore simplement attendre.

Une des principales caractéristiques des designs de Karim sont, à priori, ses combinaisons de couleurs impossibles. Les produits Sancal sont quant à eux moins stridents. Avec Float, nous avons rencontré un parfait équilibre, en donnant de l'importance aux textures et en réservant les notes de couleurs à des petits détails comme les repose-bras et les coussins.

Chaque composant du Float (accoudoirs, assise, dossier, appuie-tête) peut être choisi dans un revêtement différent, mais il existe aussi une version avec le choix d'un tissu unique.

Float existe dans 3 dimensions : 2 canapés avec dossier bas et 1 canapé avec dossier haut. Ce dernier possède différentes configurations : en plus des bras droits, il est possible de choisir un bras incliné qui permet de s'allonger en mode Divan. On peut aussi intégrer des portemanteaux sur la version dossier haut, comme s'il s'agissait d'un mur.

Pour les coussins et les appuie-tête, Karim a dessiné une série de motifs nommés Cairo (Le Caire). La collection est inspirée de son Egipte natale. Sous une optique très contemporaine Karim associe tradition et souvenirs personnels, et teint de couleurs lumineuses quelques dessins de géométrie organique.



FLOAT 25





FLOAT 27

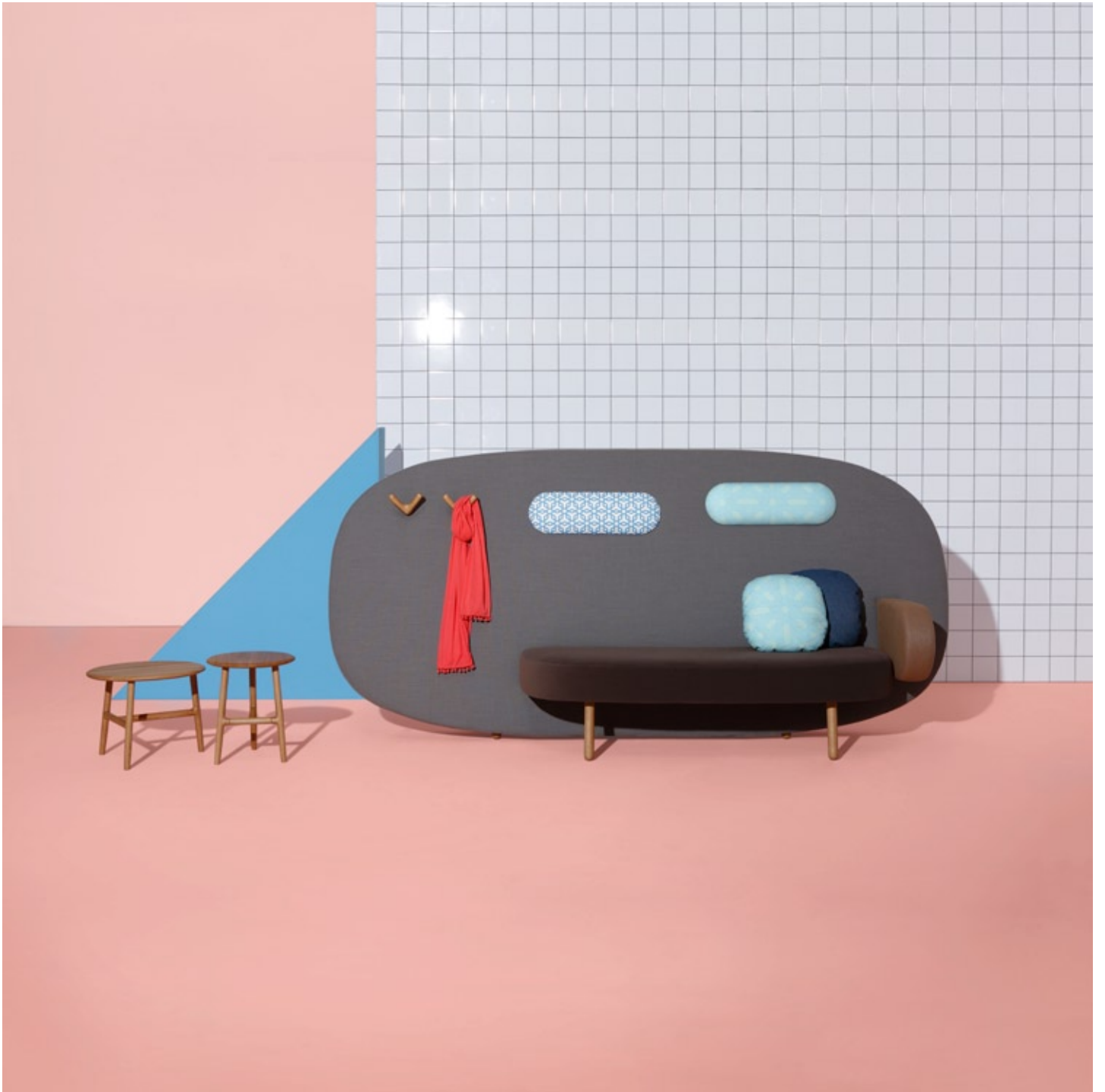

FLOAT 28



FLOAT 29



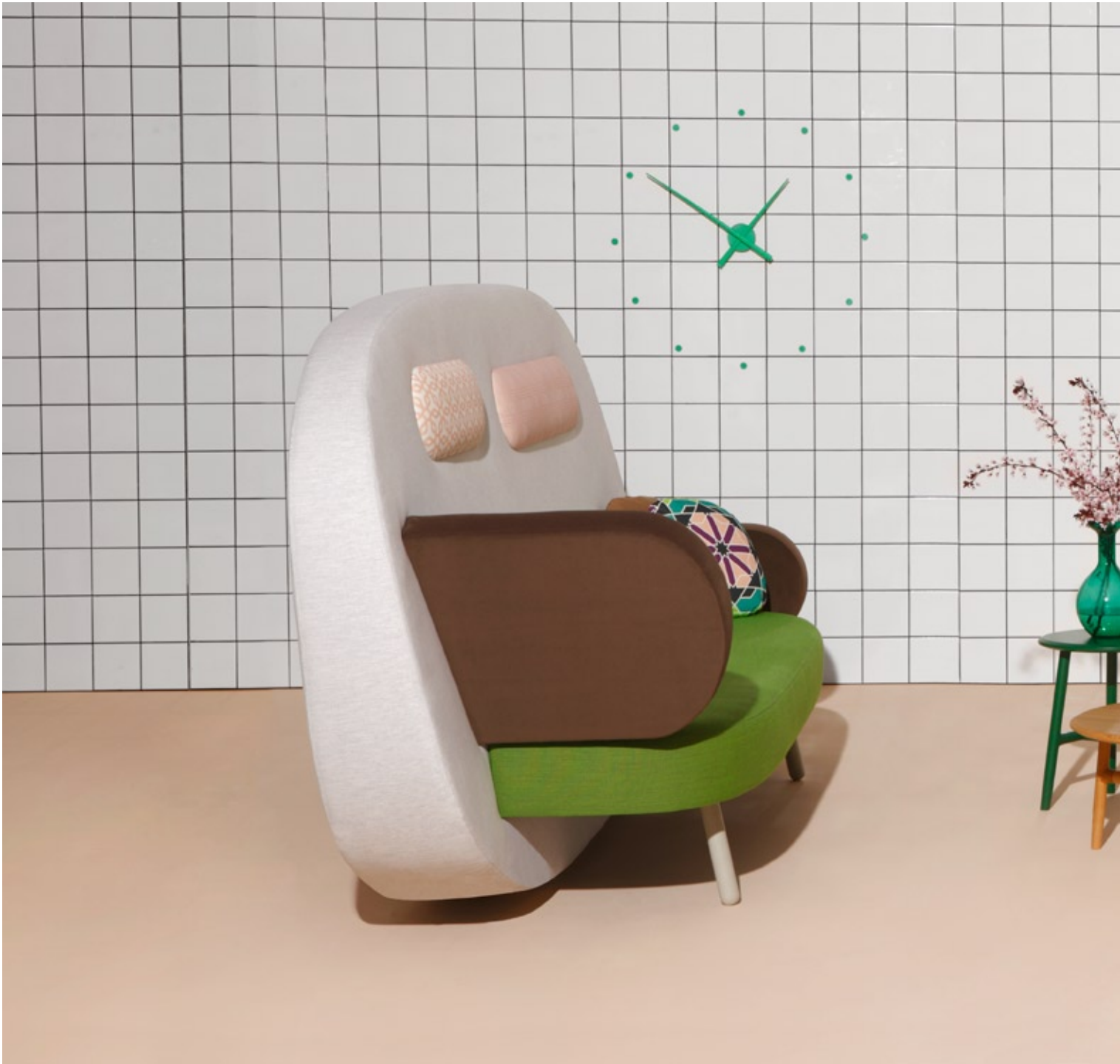

FLOAT 30









FLOAT 34



FLOAT 35



FLOAT 36



FLOAT 37



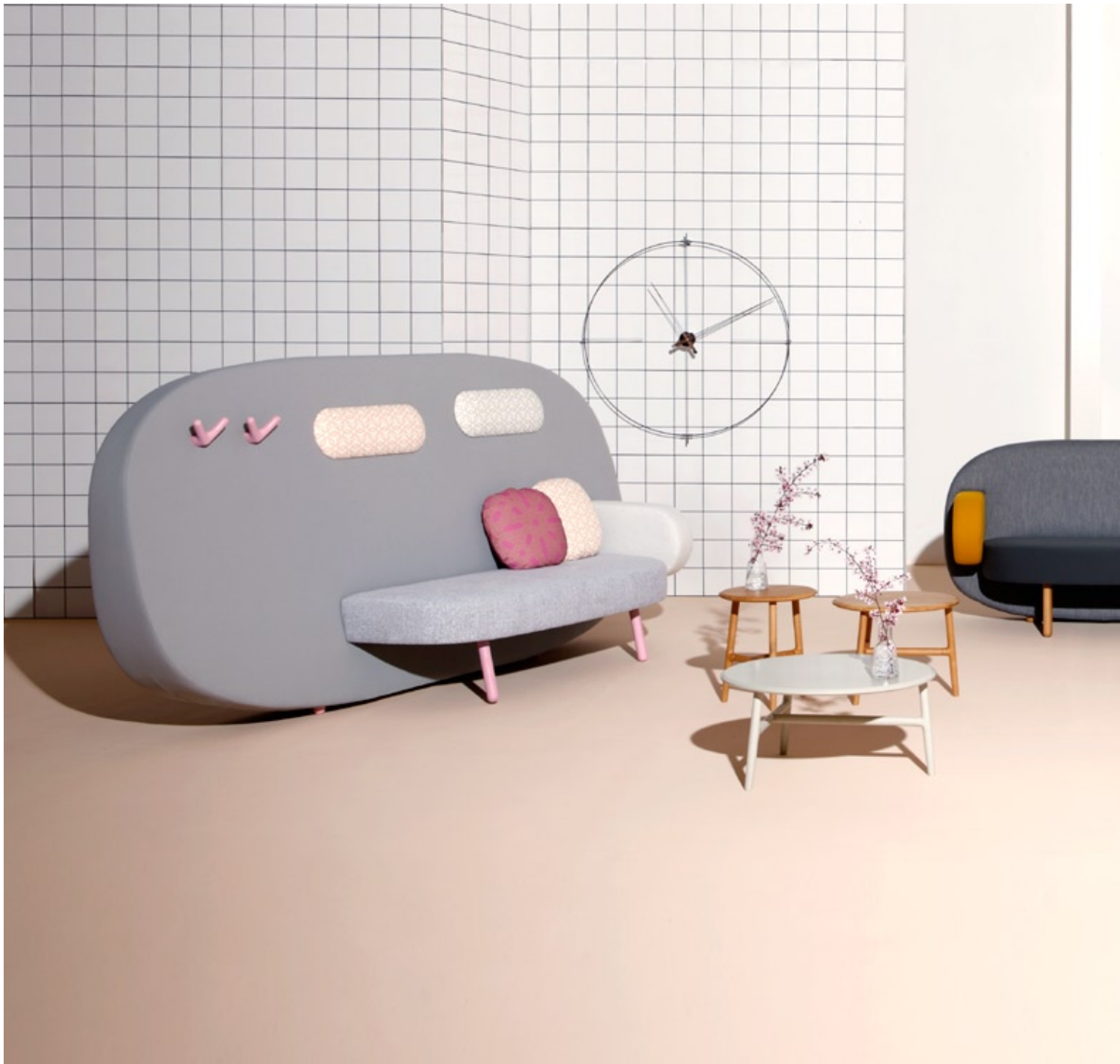

FLOAT 38



FLOAT 39



FLOAT 40



FLOAT 41

COPLA  
RAFA GARCÍA



**Rafa García** forma parte del corazón creativo de Sancal. Autor de piezas ya clásicas para la marca como Air y Eleva y de los recientes y exitosos Happen, Folk y Soul; esta temporada aflora su vena más castiza y nos propone descansar cómodamente sobre los mullidos Copla.



**Rafa García** is an essential member of Sancal's creative team. He is the author of known brand classics such as Air and Eleva and the recent and successful Happen, Folk and Soul; this season his more Castilian talent has come to surface and he now proposes comfortably resting on the soft Copla.

**Rafa García** fait partie du cœur créatif de Sancal. Auteur de pièces incontournables comme le Air et l' Eleva ou encore des succès récents comme le Happen, Folk ou Soul. Cette année, celui-ci nous propose un repos mérité sur le très confortable Copla.

# COPLA

## El más mullido y castizo.

Las torneadas patas de madera de fresno de este mullido sofá inspiran el nombre de un diseño que homenajea los antiguos cafés cantante.

De Copla también destacamos la suavidad de sus formas y sus ahuecadas almohadas. Formalmente el diseño surge de la voluntad de crear un sofá con cómodos cojines y esbeltas patas de madera. Las almohadas se unen entre ellas mediante las patas que las sustentan aligerando al máximo su estructura interna y dando lugar a un sofá mórbido por todos y cada uno de sus lados.

Copla es un sofá modular pensado para dotar de calidez y verdadero confort espacios públicos de toda índole. Gracias al aspecto desenfadado sus almohadas, consigue diferenciarse de la rigidez típica del mobiliario para colectividades. Este suave toque hace que Copla no quede excluido de entornos más hogareños.

La ligereza de Copla está determinada por unas patas de 21 cm de alto. Asimismo la ausencia estructura exterior da lugar a unas dimensiones generales muy reducidas.

Dos tipos de brazo, 3 sillones, 12 sofás, 9 módulos diferentes y 1 ángulo, permiten componer una melodía a la medida de cada proyecto. Recomendamos crear las composiciones angulares con cualquiera de las piezas de brazo alto, aunque también existe el ángulo recto.

Las visibles y flamencas patas de Copla se pueden tinter en los clásicos tonos de la madera, y también en nuevos y vibrantes colores.

## A Spanish pure breed sofa

The shapely ash tree wooden legs of this soft sofa inspire the name of a design that pays homage to old café theatres.

Also worth highlighting about the Copla are its soft shapes and plump cushions. The design, in fact, originates from the will to create a sofa with comfortable cushions and slim wooden legs. The cushions are joined together at the legs, which keep them together making the inner structure extremely light. This creates a sofa that is delicate and soft all over.

Copla is a modular sofa designed to provide warmth and real comfort to public spaces of all kinds. Thanks to the casual look of its cushions, it stands out from the typical stiffness of other public furniture items. Its soft look ensures it is not left out of other more domestic atmospheres.

The lightness of the Copla stems from its 21 cm long legs. Also, the absence of an outer structure means, in general, smaller measurements.

Two different arms, 3 armchairs, 12 sofas, 9 different modules and 1 angle allow combining this sofa to tailor for each project – a bit like writing a song. We recommend you create angle combinations with any of the high arm pieces, although there is also the right angle option.

The visible, 'Flamenco' style legs of the Copla can be stained in classic wood colours and also in new vibrant colours.

## Le plus pur et moelleux

Les pieds en frêne tournés de ce canapé moelleux inspirent le design rendant hommage aux cafés d'antan.

Les douceurs de ses formes s'associent à la générosité de ses coussins. Le design surgit formellement de la volonté de créer un canapé aux coussins très confortables associés à un piétement bois le plus simple possible. Les coussins sont unis entre eux à l'aide des piétements qui les soutiennent, allégeant au maximum la structure interne et donnant lieu à un ensemble accueillant pour tous.

Copla est un canapé modulable pensé pour équiper les espaces publics de tout type avec qualité et un réel confort. Grâce à l'aspect désinvolte de ses coussins, Copla réussit à se différencier de la rigidité typique du mobilier de collectivité. Pour ces mêmes raisons, ce modèle peut aussi être intégré à des intérieurs plus personnels.

La légèreté de Copla s'explique par un piétement de 21 cm de hauteur. L'absence de structure extérieure réduit les dimensions générales du produit.

2 types de bras, 3 fauteuils, 12 canapés, 9 modules différents et 1 angle permettent de composer sa propre mélodie en fonction des espaces. Nous recommandons les compositions en angle avec deux modules bras haut, bien que le module d'angle droit existe.

Les pieds sont réalisables dans les finitions traditionnelles ainsi que dans les nouvelles couleurs.





COPLA 45





COPLA 46



COPLA 47



COPLA 48



COPLA 49



COPLA 50



COPLA 51



COPLA 52



COPLA 53





COPLA 54



COPLA 55



COPLA 56



COPLA 57

# NUDO JUAN IBÁÑEZ LAX



**Juan Ibáñez Lax** se define como una persona inquieta que busca soluciones frescas, simples y sobre todo bien estructuradas. Tras una dilatada experiencia como diseñador gráfico, rompe un tabú y se lanza al diseño de producto con la colección de mesas Nudo. Celebramos su estreno junto a Sancal.



**Juan Ibáñez Lax** is a restless individual, dedicated to finding simple, fresh and above all, well-designed solutions. After extensive experience as a graphic designer, he broke taboo by launching himself into product design with the Nudo table collection. We are celebrating his release together with Sancal.

**Juan Ibáñez Lax** se définit comme une personne inquiète à la recherche de solutions simples, fraîches, et surtout bien étudiées. Suite à une expérience comme designer graphique, il est passé directement au design de la gamme Nudo. Nous le félicitons pour ses débuts auprès de la société Sancal.

# NUDO

## Juego de asimetrías en perfecto equilibrio.

El nombre de la colección hace referencia a los nudos de la madera en estado natural. Gracias a un esmerado y artesanal trabajo de torno, las patas, como si de ramas se tratara, simulan los nervios del tronco de un árbol. Esta unión es uno de los elementos más característicos de las mesas Nudo. La asimetría que generan sus patas es otra de sus señas de identidad.

La colección de mesas Nudo es plural y versátil. Las mesas auxiliares, realizadas en roble natural, roble tintado o mármol apomazado, tienen distintas alturas y diámetros. Esta amplia variedad permite crear interesantes combinaciones y darles un uso alternativo. Como mesa de comedor, sus cuatro tamaños se adaptan todo tipo de espacios.

## Asymmetrical combinations poised in perfect balance.

The name of the collection, Nudo, refers to the knots found in wood in its natural state. The legs replicate the sinews of a tree-trunk, as if they were branches, thanks to painstaking lathing and carving. This is one of the Nudo tables' most characteristic features. Asymmetry is another hallmark. The asymmetry is generated by the various heights of the cross beams which structure the dining tables, and by the three legs of the small round tables.

The Nudo table collection is varied and versatile. The small tables, in natural or stained oak or marble, vary in height and diameter. The lightness and wide variety of sizes and finishes enable the creation of interesting combinations, giving them alternative uses. The small table with a 38 diameter can also be used as a stool. The dining table's four sizes can be adapted to all kinds of spaces.

## Jeu d'asymétrie en parfait équilibre

Le nom de la collection fait référence aux nœuds que l'on trouve dans le bois à l'état naturel. Grâce à un travail artisanal très soigné de tournage et de coupe, les pieds simulent la nervure du tronc d'un arbre, comme s'il s'agissait de branches. Cette union est l'une des caractéristiques des tables Nudo. L'asymétrie en est une autre. Cette asymétrie est générée par les différentes hauteurs des traverses qui forment la structure de la table de salle à manger, ainsi que les 3 pieds des tables rondes.

Nudo est pluriel et versatile. Les tables auxiliaires en chêne naturel, chêne teinté ou plateau marbre, sont disponibles dans plusieurs hauteurs et diamètres. Sa légèreté et son grand choix de finitions et de dimensions permettent de créer un grand nombre de combinaisons et de lui donner une utilisation alternative. La table diamètre 38 fait aussi office de tabouret. Les 4 versions de la table de salle à manger s'adaptent à tout type d'espace.



NUDO 61





NUDO 62



NUDO 63



NUDO 64



NUDO 65



NUDO 66



NUDO 67



NUDO 68



NUDO 69





NUDO 70



NUDO 71

# MAKING OF





# Technical index

Party pag7

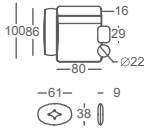

| UNI. | MOD.  | DESCRIPCIÓN / DESCRIPTION / DESCRIPTION                                                             | REF.        | ACABADO FINISHES FINITION | TELAS FABRIC TISSUS | SERIES | MUESTRARIO SAMPLE | PUNTOS POINTS POINTS |
|------|-------|-----------------------------------------------------------------------------------------------------|-------------|---------------------------|---------------------|--------|-------------------|----------------------|
| 1    | PARTY | MODULO 80<br>MODULE 80<br>MODULE 80                                                                 | 277.121.J   | -                         | STEP<br>67007/6082  | B/E    | STEP/93           | 429                  |
| 1    | PARTY | BRAZO LARGO IZDO<br>LONG LEFT ARM<br>BRAS LONG GAUCHE                                               | 277.135.I   | -                         | STEP 67007          | B      | STEP              | 132                  |
| 1    | PARTY | BRAZO AUXILIAR CON MESA DCHO<br>AUXILIARY RIGHT ARM WITH TABLE<br>BRAS AUXILIAIRE AVEC TABLE DROITE | 277.138.K.D | 002                       | STEP 67007          | B      | STEP              | 109                  |
| 1    | PARTY | COJIN 61X38X9<br>CUSHION 61X38X9<br>COUSSIN 61X38X9                                                 | 277.24.GE.W | -                         | STEP<br>67007/6082  | B      | STEP/93           | 47                   |

Party pag8

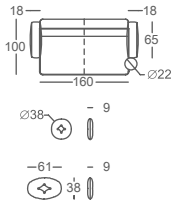

| UNI. | MOD.  | DESCRIPCIÓN / DESCRIPTION / DESCRIPTION                                                 | REF.        | ACABADO FINISHES FINITION | TELAS FABRIC TISSUS | SERIES | MUESTRARIO SAMPLE | PUNTOS POINTS POINTS |
|------|-------|-----------------------------------------------------------------------------------------|-------------|---------------------------|---------------------|--------|-------------------|----------------------|
| 1    | PARTY | MODULO 160<br>MODULE 160<br>MODULE 160                                                  | 277.121.S   | -                         | 6070/8043           | E/J    | 93/97             | 762                  |
| 1    | PARTY | BRAZO CORTO IZDO<br>SHORT LEFT ARM<br>BRAS COURT GAUCHE                                 | 277.136.I   | -                         | 8043                | J      | 97                | 160                  |
| 1    | PARTY | BRAZO CORTO CON MESA DCHO<br>SHORT RIGHT ARM WITH TABLE<br>BRAS COURT AVEC TABLE DROITE | 277.136.K.D | 002                       | 8043                | J      | 97                | 206                  |
| 1    | PARTY | COJIN D38X9<br>CUSHION D38X9<br>COUSSIN D38X9                                           | 277.24.D.W  | -                         | 8040/8043           | J      | 97                | 51                   |
| 1    | PARTY | COJIN 61X38X9<br>CUSHION 61X38X9<br>COUSSIN 61X38X9                                     | 277.24.GE.W | -                         | 6070/8043           | E      | 93/97             | 59                   |

Party pag9

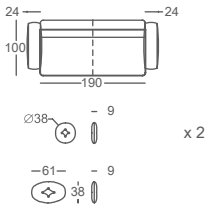

| UNI. | MOD.  | DESCRIPCIÓN / DESCRIPTION / DESCRIPTION               | REF.        | ACABADO FINISHES FINITION | TELAS FABRIC TISSUS | SERIES | MUESTRARIO SAMPLE | PUNTOS POINTS POINTS |
|------|-------|-------------------------------------------------------|-------------|---------------------------|---------------------|--------|-------------------|----------------------|
| 1    | PARTY | MODULO 190<br>MODULE 190<br>MODULE 190                | 277.121.V   | -                         | 1631/1634           | A      | 101               | 677                  |
| 1    | PARTY | BRAZO LARGO IZDO<br>LONG LEFT ARM<br>BRAS LONG GAUCHE | 277.135.I   | -                         | 1634                | A      | 101               | 140                  |
| 1    | PARTY | BRAZO LARGO DCHO<br>LONG RIGHT ARM<br>BRAS LONG DROIT | 277.135.D   | -                         | 1634                | A      | 101               | 140                  |
| 2    | PARTY | COJIN D38X9<br>CUSHION D38X9<br>COUSSIN D38X9         | 277.24.D.W  | -                         | 1631/1634           | A      | 101               | 39                   |
| 1    | PARTY | COJIN 61X38X9<br>CUSHION 61X38X9<br>COUSSIN 61X38X9   | 277.24.GE.W | -                         | 1631/1634           | A      | 101               | 49                   |

Party pag12-13

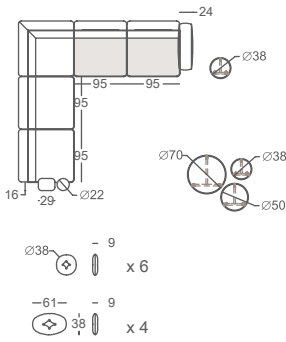

| UNI. | MOD.  | DESCRIPCIÓN / DESCRIPTION / DESCRIPTION                                                            | REF.        | ACABADO FINISHES FINITION | TELAS FABRIC TISSUS | SERIES | MUESTRARIO SAMPLE | PUNTOS POINTS POINTS |
|------|-------|----------------------------------------------------------------------------------------------------|-------------|---------------------------|---------------------|--------|-------------------|----------------------|
| 1    | PARTY | MODULO 95<br>MODULE 95<br>MODULE 95                                                                | 277.121.K   | -                         | 6081/8036           | E/J    | 93/97             | 518                  |
| 1    | PARTY | BRAZO AUXILIAR CON MESA IZDO<br>AUXILIARY LEFT ARM WITH TABLE<br>BRAS AUXILIAIRE AVEC TABLE GAUCHE | 277.138.K.I | 002                       | 6081                | E      | 93                | 120                  |
| 1    | PARTY | MODULO 95<br>MODULE 95<br>MODULE 95                                                                | 277.121.K   | -                         | 6081/8036           | E/J    | 93/97             | 518                  |
| 1    | PARTY | ANGULO 100X100<br>CORNER 100X100<br>ANGLE 100X100                                                  | 277.161     | -                         | 6081/8036           | E/J    | 93/97             | 595                  |
| 1    | PARTY | MODULO 95 CON ALMOHADA<br>MODULE 95 WITH CUSHION<br>MODULE 95 AVEC COUSSIN                         | 277.121.K.V | -                         | 6081/8036           | E/J    | 93/97             | 549                  |
| 1    | PARTY | MODULO 95 CON ALMOHADA<br>MODULE 95 WITH CUSHION<br>MODULE 95 AVEC COUSSIN                         | 277.121.K.V | -                         | 6081/8036           | E/J    | 93/97             | 549                  |
| 1    | PARTY | BRAZO LARGO DCHO<br>LONG RIGHT ARM<br>BRAS LONG DROIT                                              | 277.135.D   | -                         | 8036                | J      | 97                | 187                  |

|   |       |                                                     |              |     |                                        |   |         |     |
|---|-------|-----------------------------------------------------|--------------|-----|----------------------------------------|---|---------|-----|
| 2 | PARTY | COJIN D38X9<br>CUSHION D38X9<br>COUSSIN D38X9       | 277.24.D.W   | -   | 1631/1634                              | A | 101     | 39  |
| 1 | PARTY | COJIN D38X9<br>CUSHION D38X9<br>COUSSIN D38X9       | 277.24.D.W   | -   | 8040/8043                              | J | 97      | 51  |
| 1 | PARTY | COJIN D38X9<br>CUSHION D38X9<br>COUSSIN D38X9       | 277.24.D.W   | -   | 6072/6075                              | E | 93      | 46  |
| 1 | PARTY | COJIN D38X9<br>CUSHION D38X9<br>COUSSIN D38X9       | 277.24.D.W   | -   | STEP<br>62057/8041                     | B | STEP/97 | 38  |
| 1 | PARTY | COJIN D38X9<br>CUSHION D38X9<br>COUSSIN D38X9       | 277.24.D.W   | -   | STEP 68119/<br>STEP MELA-<br>NIE 68119 | B | STEP    | 38  |
| 1 | PARTY | COJIN 61X38X9<br>CUSHION 61X38X9<br>COUSSIN 61X38X9 | 277.24.GE.W  | -   | STEP<br>67007/6082                     | B | STEP/93 | 47  |
| 1 | PARTY | COJIN 61X38X9<br>CUSHION 61X38X9<br>COUSSIN 61X38X9 | 277.24.GE.W  | -   | STEP 68119/<br>STEP MELA-<br>NIE 68119 | B | STEP    | 47  |
| 1 | PARTY | COJIN 61X38X9<br>CUSHION 61X38X9<br>COUSSIN 61X38X9 | 277.24.GE.W  | -   | 6076/6055                              | E | 93/92   | 59  |
| 1 | PARTY | COJIN 61X38X9<br>CUSHION 61X38X9<br>COUSSIN 61X38X9 | 277.24.GE.W  | -   | 6057/6050                              | E | 92      | 59  |
| 1 | NUDO  | MESA Ø38X45<br>TABLE Ø38X45<br>TABLE Ø38X45         | 280.71.DDE.Y | 002 | -                                      | - | -       | 184 |
| 1 | NUDO  | MESA Ø38X45<br>TABLE Ø38X45<br>TABLE Ø38X45         | 280.71.DDE.Y | 045 | -                                      | - | -       | 192 |
| 1 | NUDO  | MESA Ø50X40<br>TABLE Ø50X40<br>TABLE Ø50X40         | 280.71.FFE.Y | 002 | -                                      | - | -       | 209 |
| 1 | NUDO  | MESA Ø70X35<br>TABLE Ø70X35<br>TABLE Ø70X35         | 280.71.HHD.Y | 043 | -                                      | - | -       | 261 |

### Party 24H.

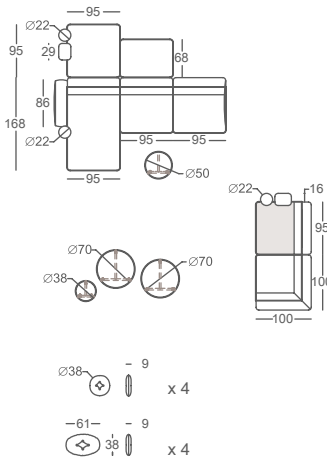

| UNI. | MOD.  | DESCRIPCIÓN / DESCRIPTION / DESCRIPTION                                                             | REF.        | ACABADO<br>FINISHES<br>FINITION | TELAS<br>FABRIC<br>TISSUS | SERIES | MUESTRARIO<br>SAMPLE | PUNTOS<br>POINTS<br>POINTS |
|------|-------|-----------------------------------------------------------------------------------------------------|-------------|---------------------------------|---------------------------|--------|----------------------|----------------------------|
| 1    | PARTY | CHAISE LONGUE 95<br>CHAISE LONGUE 95<br>CHAISE LONGUE 95                                            | 277.141.KR  | -                               | 6076/6055                 | E      | 93/92                | 623                        |
| 1    | PARTY | BRAZO LARGO CON MESA IZDO<br>LONG LEFT ARM WITH TABLE<br>BRAS LONG AVEC TABLE GAUCHE                | 277.135.K.I | 002                             | 6055                      | E      | 92                   | 213                        |
| 1    | PARTY | MÓDULO 95<br>MODULE 95<br>MODULE 95                                                                 | 277.121.K   | -                               | 6076/6055                 | E      | 93/92                | 480                        |
| 1    | PARTY | MÓDULO 95 CON ALMOHADA<br>MODULE 95 WITH CUSHION<br>MODULE 95 AVEC COUSSIN                          | 277.121.K.V | -                               | 8025/6057                 | J/E    | 94/92                | 549                        |
| 1    | PARTY | PUF 95x95<br>POUF 95X95<br>POUF 95X95                                                               | 277.151.KK  | -                               | 8025/6057                 | J/E    | 94/92                | 348                        |
| 1    | PARTY | BRAZO AUXILIAR CON MESA DCHO<br>AUXILIARY RIGHT ARM WITH TABLE<br>BRAS AUXILIAIRE AVEC TABLE DROITE | 277.138.K.D | 002                             | 8025                      | J      | 94                   | 127                        |
| 1    | PARTY | PUF 95x68<br>POUF 95X68<br>POUF 95X68                                                               | 277.151.KG  | -                               | 1623/8037                 | A/J    | 98/97                | 272                        |
| 1    | PARTY | MÓDULO 95 CON ALMOHADA<br>MODULE 95 WITH CUSHION<br>MODULE 95 AVEC COUSSIN                          | 277.121.K.V | -                               | 1623/8037                 | A/J    | 98/97                | 519                        |
| 1    | PARTY | BRAZO AUXILIAR CON MESA IZDO<br>AUXILIARY LEFT ARM WITH TABLE<br>BRAS AUXILIAIRE AVEC TABLE GAUCHE  | 277.138.K.I | 002                             | 8037                      | J      | 97                   | 127                        |
| 1    | PARTY | ÁNGULO 100X100<br>CORNER 100X100<br>ANGLE 100X100                                                   | 277.161     | -                               | 1623/8037                 | A/J    | 98/97                | 563                        |
| 1    | PARTY | COJIN D38X9<br>CUSHION D38X9<br>COUSSIN D38X9                                                       | 277.24.D.W  | -                               | 6055/6076                 | E      | 92/93                | 46                         |
| 1    | PARTY | COJIN D38X9<br>CUSHION D38X9<br>COUSSIN D38X9                                                       | 277.24.D.W  | -                               | 8025/6057                 | J      | 94/92                | 51                         |

|   |       |                                                     |              |     |                    |   |         |     |
|---|-------|-----------------------------------------------------|--------------|-----|--------------------|---|---------|-----|
| 1 | PARTY | COJIN D38X9<br>CUSHION D38X9<br>COUSSIN D38X9       | 277.24.D.W   | -   | 1631/3843          | A | 101/83  | 39  |
| 1 | PARTY | COJIN D38X9<br>CUSHION D38X9<br>COUSSIN D38X9       | 277.24.D.W   | -   | STEP<br>62057/8041 | B | STEP/97 | 38  |
| 1 | PARTY | COJIN 61X38X9<br>CUSHION 61X38X9<br>COUSSIN 61X38X9 | 277.24.GE.W  | -   | 8037/1623          | J | 97/98   | 66  |
| 1 | PARTY | COJIN 61X38X9<br>CUSHION 61X38X9<br>COUSSIN 61X38X9 | 277.24.GE.W  | -   | 1631/3843          | A | 101/83  | 49  |
| 1 | PARTY | COJIN 61X38X9<br>CUSHION 61X38X9<br>COUSSIN 61X38X9 | 277.24.GE.W  | -   | 6055/6076          | E | 92/93   | 59  |
| 1 | PARTY | COJIN 61X38X9<br>CUSHION 61X38X9<br>COUSSIN 61X38X9 | 277.24.GE.W  | -   | 1631/3843          | A | 101/83  | 49  |
| 1 | PARTY | COJIN 61X38X9<br>CUSHION 61X38X9<br>COUSSIN 61X38X9 | 277.24.GE.W  | -   | 6057/6050          | E | 92      | 59  |
| 1 | NUDO  | MESA Ø50X40<br>TABLE Ø50X40<br>TABLE Ø50X40         | 280.71.FFE.Y | 002 | -                  | - | -       | 209 |
| 1 | NUDO  | MESA Ø38X45<br>TABLE Ø38X45<br>TABLE Ø38X45         | 280.71.DDE.Y | 002 | -                  | - | -       | 184 |
| 1 | NUDO  | MESA Ø70X35<br>TABLE Ø70X35<br>TABLE Ø70X35         | 280.71.HHD.Y | 049 | -                  | - | -       | 261 |
| 1 | NUDO  | MESA Ø70X35<br>TABLE Ø70X35<br>TABLE Ø70X35         | 280.71.HHD.Y | 043 | -                  | - | -       | 261 |

Party pag 14-15

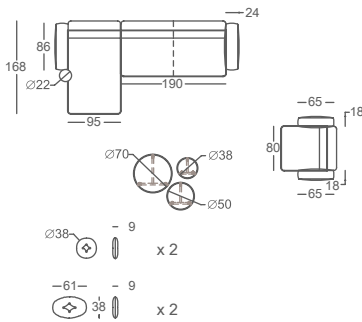

| UNL. | MOD.  | DESCRIPCIÓN / DESCRIPTION / DESCRIPTION                                              | REF.         | ACABADO FINISHES FINITION | TELAS FABRIC TISSUS | SERIES | MUESTRARIO SAMPLE | PUNTOS POINTS POINTS |
|------|-------|--------------------------------------------------------------------------------------|--------------|---------------------------|---------------------|--------|-------------------|----------------------|
| 1    | PARTY | CHAISE LONGUE 95<br>CHAISE LONGUE 95<br>CHAISE LONGUE 95                             | 277.141.KR   | -                         | 3853/1636           | C/A    | 83/101            | 564                  |
| 1    | PARTY | BRAZO LARGO CON MESA IZDO<br>LONG LEFT ARM WITH TABLE<br>BRAS LONG AVEC TABLE GAUCHE | 277.135.K.I  | 002                       | 1636                | A      | 101               | 185                  |
| 1    | PARTY | MODULO 190<br>MODULE 190<br>MODULE 190                                               | 277.121.V    | -                         | 3853/1636           | C/A    | 83/101            | 682                  |
| 1    | PARTY | BRAZO LARGO DCHO<br>LONG RIGHT ARM<br>BRAS LONG DROIT                                | 277.135.D    | -                         | 1636                | A      | 101               | 140                  |
| 1    | PARTY | COJIN D38X9<br>CUSHION D38X9<br>COUSSIN D38X9                                        | 277.24.D.W   | -                         | 3853/1636           | C      | 83/101            | 36                   |
| 1    | PARTY | COJIN 61X38X9<br>CUSHION 61X38X9<br>COUSSIN 61X38X9                                  | 277.24.GE.W  | -                         | 3853/1636           | C      | 83/101            | 45                   |
| 1    | PARTY | COJIN 61X38X9<br>CUSHION 61X38X9<br>COUSSIN 61X38X9                                  | 277.24.GE.W  | -                         | 8037/1636           | J      | 97/101            | 66                   |
| 1    | PARTY | MODULO 80<br>MODULE 80<br>MODULE 80                                                  | 277.121.J    | -                         | 3843/1631           | C/A    | 83/101            | 397                  |
| 1    | PARTY | BRAZO CORTO IZDO<br>SHORT LEFT ARM<br>BRAS COURT GAUCHE                              | 277.136.I    | -                         | 1631                | A      | 101               | 119                  |
| 1    | PARTY | BRAZO CORTO DCHO<br>SHORT RIGHT ARM<br>BRAS COURT DROIT                              | 277.136.D    | -                         | 1631                | A      | 101               | 119                  |
| 1    | PARTY | COJIN 61X38X9<br>CUSHION 61X38X9<br>COUSSIN 61X38X9                                  | 277.24.GE.W  | -                         | 3843/1631           | C      | 83/101            | 45                   |
| 1    | NUDO  | MESA Ø38X45<br>TABLE Ø38X45<br>TABLE Ø38X45                                          | 280.71.DDE.Y | 043                       | -                   | -      | -                 | 192                  |
| 1    | NUDO  | MESA Ø50X40<br>TABLE Ø50X40<br>TABLE Ø50X40                                          | 280.71.FFE.Y | 002                       | -                   | -      | -                 | 209                  |
| 1    | NUDO  | MESA Ø70X35<br>TABLE Ø70X35<br>TABLE Ø70X35                                          | 280.71.HHD.Y | 049                       | -                   | -      | -                 | 261                  |



Party pag16

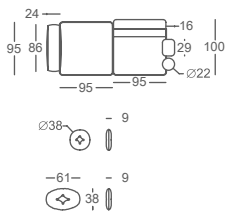

| UNI. | MOD.  | DESCRIPCIÓN / DESCRIPTION / DESCRIPTION                                                             | REF.        | ACABADO FINISHES FINITION | TELAS FABRIC TISSUS | SERIES | MUESTRARIO SAMPLE | PUNTOS POINTS POINTS |
|------|-------|-----------------------------------------------------------------------------------------------------|-------------|---------------------------|---------------------|--------|-------------------|----------------------|
| 1    | PARTY | PUF 95x95<br>POUF 95X95<br>POUF 95X95                                                               | 277.151.KK  | -                         | STEP<br>62057/8041  | B/J    | STEP/97           | 326                  |
| 1    | PARTY | BRAZO LARGO IZDO<br>LONG LEFT ARM<br>BRAS LONG GAUCHE                                               | 277.135.I   | -                         | 8041                | J      | 97                | 187                  |
| 1    | PARTY | MODULO 95<br>MODULE 95<br>MODULE 95                                                                 | 277.121.K   | -                         | STEP<br>62057/8041  | B/J    | STEP/97           | 484                  |
| 1    | PARTY | BRAZO AUXILIAR CON MESA DCHO<br>AUXILIARY RIGHT ARM WITH TABLE<br>BRAS AUXILIAIRE AVEC TABLE DROITE | 277.138.K.D | 002                       | 8041                | J      | 97                | 127                  |
| 1    | PARTY | COJIN D38X9<br>CUSHION D38X9<br>COUSSIN D38X9                                                       | 277.24.D.W  | -                         | STEP<br>62057/8041  | B      | STEP/97           | 38                   |
| 1    | PARTY | COJIN 61X38X9<br>CUSHION 61X38X9<br>COUSSIN 61X38X9                                                 | 277.24.GE.W | -                         | 6057/8041           | E      | 92/97             | 59                   |

Party pag17

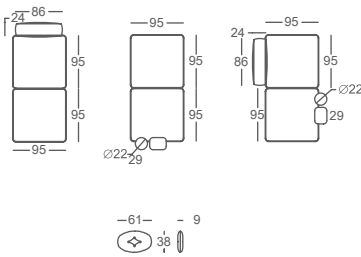

| UNI. | MOD.  | DESCRIPCIÓN / DESCRIPTION / DESCRIPTION                                                             | REF.        | ACABADO FINISHES FINITION | TELAS FABRIC TISSUS | SERIES | MUESTRARIO SAMPLE | PUNTOS POINTS POINTS |
|------|-------|-----------------------------------------------------------------------------------------------------|-------------|---------------------------|---------------------|--------|-------------------|----------------------|
| 1    | PARTY | PUF 95x95<br>POUF 95X95<br>POUF 95X95                                                               | 277.151.KK  | -                         | 8037/1623           | J/A    | 97/98             | 330                  |
| 1    | PARTY | PUF 95x95<br>POUF 95X95<br>POUF 95X95                                                               | 277.151.KK  | -                         | 8037/1623           | J/A    | 97/98             | 330                  |
| 1    | PARTY | BRAZO LARGO DCHO<br>LONG RIGHT ARM<br>BRAS LONG DROIT                                               | 277.135.D   | -                         | 8037                | J      | 97                | 187                  |
| 1    | PARTY | COJIN 61X38X9<br>CUSHION 61X38X9<br>COUSSIN 61X38X9                                                 | 277.24.GE.W | -                         | 8037/1623           | J      | 97/98             | 66                   |
| 1    | PARTY | PUF 95x95<br>POUF 95X95<br>POUF 95X95                                                               | 277.151.KK  | -                         | 8037/1623           | J/A    | 97/98             | 330                  |
| 1    | PARTY | PUF 95x95<br>POUF 95X95<br>POUF 95X95                                                               | 277.151.KK  | -                         | 8037/1623           | J/A    | 97/98             | 330                  |
| 1    | PARTY | BRAZO AUXILIAR CON MESA DCHO<br>AUXILIARY RIGHT ARM WITH TABLE<br>BRAS AUXILIAIRE AVEC TABLE DROITE | 277.138.K.D | 002                       | 1623                | A      | 98                | 112                  |
| 1    | PARTY | PUF 95x95<br>POUF 95X95<br>POUF 95X95                                                               | 277.151.KK  | -                         | 8037/1623           | J/A    | 97/98             | 330                  |
| 1    | PARTY | BRAZO LARGO DCHO<br>LONG RIGHT ARM<br>BRAS LONG DROIT                                               | 277.135.D   | -                         | 8037                | J      | 97                | 187                  |
| 1    | PARTY | PUF 95x95<br>POUF 95X95<br>POUF 95X95                                                               | 277.151.KK  | -                         | 8037/1623           | J/A    | 97/98             | 330                  |
| 1    | PARTY | BRAZO AUXILIAR CON MESA DCHO<br>AUXILIARY RIGHT ARM WITH TABLE<br>BRAS AUXILIAIRE AVEC TABLE DROITE | 277.138.K.D | 002                       | 1623                | A      | 98                | 112                  |

Party pag18-19

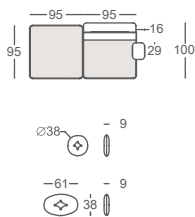

| UNI. | MOD.  | DESCRIPCIÓN / DESCRIPTION / DESCRIPTION                                                             | REF.         | ACABADO FINISHES FINITION | TELAS FABRIC TISSUS                    | SERIES | MUESTRARIO SAMPLE | PUNTOS POINTS POINTS |
|------|-------|-----------------------------------------------------------------------------------------------------|--------------|---------------------------|----------------------------------------|--------|-------------------|----------------------|
| 1    | PARTY | PUF 95x95 CON ALMOHADA<br>POUF 95X95 WITH CUSHION<br>POUF 95X95 AVEC COUSSIN                        | 277.152.KK.V | -                         | STEP<br>MELANIE<br>68119/6075          | B/E    | STEP/93           | 350                  |
| 1    | PARTY | MODULO 95 CON ALMOHADA<br>MODULE 95 WITH CUSHION<br>MODULE 95 AVEC COUSSIN                          | 277.121.K.V  | -                         | STEP<br>MELANIE<br>68119/6075          | B/E    | STEP/93           | 487                  |
| 1    | PARTY | BRAZO AUXILIAR CON MESA DCHO<br>AUXILIARY RIGHT ARM WITH TABLE<br>BRAS AUXILIAIRE AVEC TABLE DROITE | 277.138.K.D  | 002                       | 6075                                   | E      | 93                | 120                  |
| 1    | PARTY | COJIN D38X9<br>CUSHION D38X9<br>COUSSIN D38X9                                                       | 277.24.D.W   | -                         | STEP 68119/<br>STEP MELA-<br>NIE 68119 | B      | STEP              | 38                   |
| 1    | PARTY | COJIN 61X38X9<br>CUSHION 61X38X9<br>COUSSIN 61X38X9                                                 | 277.24.GE.W  | -                         | STEP 68119/<br>STEP MELA-<br>NIE 68119 | B      | STEP              | 47                   |

Float pag.24-25

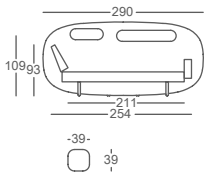

| UNI. | MOD.  | DESCRIPCIÓN / DESCRIPTION / DESCRIPTION                               | REF.      | ACABADO FINISHES FINITION | TELAS FABRIC TISSUS | SERIES | MUESTRARIO SAMPLE | PUNTOS POINTS POINTS |
|------|-------|-----------------------------------------------------------------------|-----------|---------------------------|---------------------|--------|-------------------|----------------------|
| 1    | FLOAT | RESPALDO 290<br>BACK 290<br>DOSSIER 290                               | 281.1A.Z6 | 049                       | 6051                | E      | 92                | 949                  |
| 1    | FLOAT | ASIENTO 220<br>SEAT 220<br>ASSISE 220                                 | 281.1B.Y  | 049                       | 8044                | J      | 97                | 320                  |
| 1    | FLOAT | BRAZO LARGO DCHO<br>LONG RIGHT ARM<br>BRAS LONG DROIT                 | 281.135.D | -                         | 8021                | J      | 94                | 66                   |
| 1    | FLOAT | BRAZO INCLINADO IZDO<br>INCLINED LEFT ARM<br>BRAS INCLINÉ GAUCHE      | 281.13A.I | -                         | 8021                | J      | 94                | 96                   |
| 1    | FLOAT | CABEZAL CORTO IZDO<br>LEFT SHORT HEADBOARD<br>APPUI-TÊTE COURT GAUCHE | 281.251.I | -                         | CAIRO 101           | X      | CAIRO             | 28                   |
| 1    | FLOAT | CABEZAL LARGO DCHO<br>RIGHT LARGE HEADBOARD<br>APPUI-TÊTE LONG DROIT  | 281.252.D | -                         | CAIRO 301           | X      | CAIRO             | 33                   |
| 1    | FLOAT | COJIN 39X39<br>CUSHION 39X39<br>COUSSIN 39X39                         | 281.22.DD | -                         | CAIRO 201           | X      | CAIRO             | 34                   |

Float pag.26-27

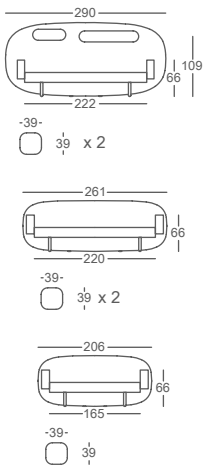

| UNI. | MOD.  | DESCRIPCIÓN / DESCRIPTION / DESCRIPTION                               | REF.      | ACABADO FINISHES FINITION | TELAS FABRIC TISSUS | SERIES | MUESTRARIO SAMPLE | PUNTOS POINTS POINTS |
|------|-------|-----------------------------------------------------------------------|-----------|---------------------------|---------------------|--------|-------------------|----------------------|
| 1    | FLOAT | RESPALDO 290<br>BACK 290<br>DOSSIER 290                               | 281.1A.Z6 | 002                       | 6081                | E      | 93                | 949                  |
| 1    | FLOAT | ASIENTO 220<br>SEAT 220<br>ASSISE 220                                 | 281.1B.Y  | 002                       | 6053                | E      | 92                | 288                  |
| 1    | FLOAT | BRAZO LARGO DCHO<br>LONG RIGHT ARM<br>BRAS LONG DROIT                 | 281.135.D | -                         | 6060                | E      | 92                | 61                   |
| 1    | FLOAT | BRAZO LARGO IZDO<br>LONG LEFT ARM<br>BRAS LONG GAUCHE                 | 281.135.I | -                         | 6060                | E      | 92                | 61                   |
| 1    | FLOAT | CABEZAL CORTO IZDO<br>LEFT SHORT HEADBOARD<br>APPUI-TÊTE COURT GAUCHE | 281.251.I | -                         | STEP 62057          | B      | STEP              | 25                   |
| 1    | FLOAT | CABEZAL LARGO DCHO<br>RIGHT LARGE HEADBOARD<br>APPUI-TÊTE LONG DROIT  | 281.252.D | -                         | 8042                | J      | 97                | 39                   |
| 1    | FLOAT | COJIN 39X39<br>CUSHION 39X39<br>COUSSIN 39X39                         | 281.22.DD | -                         | CAIRO 203           | X      | CAIRO             | 34                   |
| 1    | FLOAT | COJIN 39X39<br>CUSHION 39X39<br>COUSSIN 39X39                         | 281.22.DD | -                         | 6057                | E      | 92                | 39                   |
| 1    | FLOAT | RESPALDO 261<br>BACK 261<br>DOSSIER 261                               | 281.1A.Z3 | 002                       | STEP 62057          | B      | STEP              | 538                  |
| 1    | FLOAT | ASIENTO 220<br>SEAT 220<br>ASSISE 220                                 | 281.1B.Y  | 002                       | 6057                | E      | 92                | 288                  |
| 1    | FLOAT | BRAZO CORTO IZDO<br>SHORT LEFT ARM<br>BRAS COURT GAUCHE               | 281.136.I | -                         | STEP 62057          | B      | STEP              | 50                   |
| 1    | FLOAT | BRAZO CORTO DCHO<br>SHORT RIGHT ARM<br>BRAS COURT DROIT               | 281.136.D | -                         | STEP 62057          | B      | STEP              | 50                   |
| 1    | FLOAT | COJIN 39X39<br>CUSHION 39X39<br>COUSSIN 39X39                         | 281.22.DD | -                         | CAIRO 106           | X      | CAIRO             | 34                   |
| 1    | FLOAT | COJIN 39X39<br>CUSHION 39X39<br>COUSSIN 39X39                         | 281.22.DD | -                         | CAIRO 302           | X      | CAIRO             | 34                   |
| 1    | FLOAT | RESPALDO 206<br>BACK 206<br>DOSSIER 206                               | 281.1A.W  | 002                       | STEP 61103          | B      | STEP              | 448                  |
| 1    | FLOAT | ASIENTO 165<br>SEAT 165<br>ASSISE 165                                 | 281.1B.S  | 002                       | STEP 63075          | B      | STEP              | 194                  |
| 1    | FLOAT | BRAZO CORTO IZDO<br>SHORT LEFT ARM<br>BRAS COURT GAUCHE               | 281.136.I | -                         | 6079                | E      | 93                | 61                   |
| 1    | FLOAT | BRAZO CORTO DCHO<br>SHORT RIGHT ARM<br>BRAS COURT DROIT               | 281.136.D | -                         | STEP MELANGE 63075  | B      | STEP              | 50                   |
| 1    | FLOAT | COJIN 39X39<br>CUSHION 39X39<br>COUSSIN 39X39                         | 281.22.DD | -                         | CAIRO 204           | X      | CAIRO             | 34                   |

Float pag 28

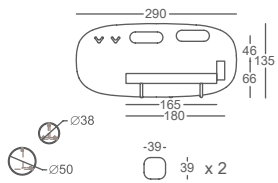

| UNL. | MOD.  | DESCRIPCIÓN / DESCRIPTION / DESCRIPTION                                                             | REF.          | ACABADO FINISHES FINITION | TELAS FABRIC TISSUS | SERIES | MUESTRARIO SAMPLE | PUNTOS POINTS POINTS |
|------|-------|-----------------------------------------------------------------------------------------------------|---------------|---------------------------|---------------------|--------|-------------------|----------------------|
| 1    | FLOAT | RESPALDO 290 CON PERCHERO IZDO<br>BACK 290 WITH LEFT HANGER<br>DOSSIER 290 AVEC PORTEMANTEAU GAUCHE | 281.1A.Z6.P.I | 002                       | 8038                | J      | 97                | 1119                 |
| 1    | FLOAT | ASIENTO 165<br>SEAT 165<br>ASSISE 165                                                               | 281.1B.S      | 002                       | 8021                | J      | 94                | 267                  |
| 1    | FLOAT | BRAZO LARGO DCHO<br>LONG RIGHT ARM<br>BRAS LONG DROIT                                               | 281.135.D     | -                         | 6057                | E      | 92                | 61                   |
| 1    | FLOAT | CABEZAL CORTO IZDO<br>LEFT SHORT HEADBOARD<br>APPUI-TÊTE COURT GAUCHE                               | 281.251.I     | -                         | CAIRO 103           | X      | CAIRO             | 28                   |
| 1    | FLOAT | CABEZAL CORTO DCHO<br>RIGHT SHORT HEADBOARD<br>APPUI-TÊTE COURT DROIT                               | 281.251.D     | -                         | CAIRO 302           | X      | CAIRO             | 28                   |
| 1    | FLOAT | COJIN 39X39<br>CUSHION 39X39<br>COUSSIN 39X39                                                       | 281.22.DD     | -                         | CAIRO 302           | X      | CAIRO             | 34                   |
| 1    | FLOAT | COJIN 39X39<br>CUSHION 39X39<br>COUSSIN 39X39                                                       | 281.22.DD     | -                         | 6055                | E      | 92                | 39                   |
| 1    | NUDO  | MESA Ø38X45<br>TABLE Ø38X45<br>TABLE Ø38X45                                                         | 280.71.DDE.Y  | 002                       | -                   | -      | -                 | 184                  |
| 1    | NUDO  | MESA Ø50X40<br>TABLE Ø50X40<br>TABLE Ø50X40                                                         | 280.71.FFE.Y  | 002                       | -                   | -      | -                 | 209                  |

Float pag 29

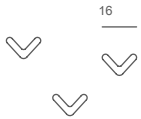

| UNL. | MOD.  | DESCRIPCIÓN / DESCRIPTION / DESCRIPTION       | REF.   | ACABADO FINISHES FINITION | TELAS FABRIC TISSUS | SERIES | MUESTRARIO SAMPLE | PUNTOS POINTS POINTS |
|------|-------|-----------------------------------------------|--------|---------------------------|---------------------|--------|-------------------|----------------------|
| 1    | FLOAT | PERCHERO PARED<br>WALL HANGER<br>PORTEMANTEAU | 281.38 | 049                       | -                   | -      | -                 | 38                   |
| 2    | FLOAT | PERCHERO PARED<br>WALL HANGER<br>PORTEMANTEAU | 281.38 | 002                       | -                   | -      | -                 | 38                   |

Float pag 30-31

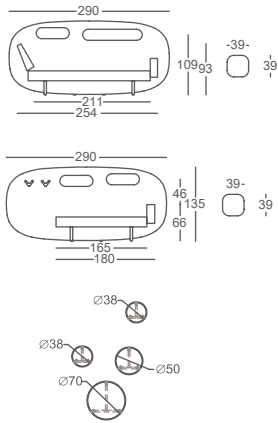

| UNL. | MOD.  | DESCRIPCIÓN / DESCRIPTION / DESCRIPTION                                                             | REF.          | ACABADO FINISHES FINITION | TELAS FABRIC TISSUS | SERIES | MUESTRARIO SAMPLE | PUNTOS POINTS POINTS |
|------|-------|-----------------------------------------------------------------------------------------------------|---------------|---------------------------|---------------------|--------|-------------------|----------------------|
| 1    | FLOAT | RESPALDO 290<br>BACK 290<br>DOSSIER 290                                                             | 281.1A.Z6     | 049                       | 6051                | E      | 92                | 949                  |
| 1    | FLOAT | ASIENTO 220<br>SEAT 220<br>ASSISE 220                                                               | 281.1B.Y      | 049                       | 8044                | J      | 97                | 320                  |
| 1    | FLOAT | BRAZO LARGO DCHO<br>LONG RIGHT ARM<br>BRAS LONG DROIT                                               | 281.135.D     | -                         | 8021                | J      | 94                | 66                   |
| 1    | FLOAT | BRAZO INCLINADO IZDO<br>INCLINED LEFT ARM<br>BRAS INCLINÉ GAUCHE                                    | 281.13A.I     | -                         | 8021                | J      | 94                | 96                   |
| 1    | FLOAT | CABEZAL CORTO IZDO<br>LEFT SHORT HEADBOARD<br>APPUI-TÊTE COURT GAUCHE                               | 281.251.I     | -                         | CAIRO 101           | X      | CAIRO             | 28                   |
| 1    | FLOAT | CABEZAL LARGO DCHO<br>RIGHT LARGE HEADBOARD<br>APPUI-TÊTE LONG DROIT                                | 281.252.D     | -                         | CAIRO 301           | X      | CAIRO             | 33                   |
| 1    | FLOAT | COJIN 39X39<br>CUSHION 39X39<br>COUSSIN 39X39                                                       | 281.22.DD     | -                         | CAIRO 201           | X      | CAIRO             | 34                   |
| 1    | FLOAT | RESPALDO 290 CON PERCHERO IZDO<br>BACK 290 WITH LEFT HANGER<br>DOSSIER 290 AVEC PORTEMANTEAU GAUCHE | 281.1A.Z6.P.I | 045                       | STEP 60004          | B      | STEP              | 884                  |
| 1    | FLOAT | ASIENTO 165<br>SEAT 165<br>ASSISE 165                                                               | 281.1B.S      | 045                       | 7163                | X      | 95                | 217                  |
| 1    | FLOAT | BRAZO LARGO DCHO<br>LONG RIGHT ARM<br>BRAS LONG DROIT                                               | 281.135.D     | -                         | 6058                | E      | 92                | 61                   |
| 1    | FLOAT | CABEZAL CORTO IZDO<br>LEFT SHORT HEADBOARD<br>APPUI-TÊTE COURT GAUCHE                               | 281.251.I     | -                         | CAIRO 101           | X      | CAIRO             | 28                   |
| 1    | FLOAT | CABEZAL CORTO DCHO<br>RIGHT SHORT HEADBOARD<br>APPUI-TÊTE COURT DROIT                               | 281.251.D     | -                         | CAIRO 105           | X      | CAIRO             | 28                   |
| 1    | FLOAT | COJIN 39X39<br>CUSHION 39X39<br>COUSSIN 39X39                                                       | 281.22.DD     | -                         | CAIRO 204           | X      | CAIRO             | 34                   |
| 1    | NUDO  | MESA Ø38X45<br>TABLE Ø38X45<br>TABLE Ø38X45                                                         | 280.71.DDE.Y  | 041                       | -                   | -      | -                 | 192                  |

|   |      |                                             |              |     |   |   |   |     |
|---|------|---------------------------------------------|--------------|-----|---|---|---|-----|
| 1 | NUDO | MESA Ø38X45<br>TABLE Ø38X45<br>TABLE Ø38X45 | 280.71.DDE.Y | 045 | - | - | - | 192 |
| 1 | NUDO | MESA Ø50X40<br>TABLE Ø50X40<br>TABLE Ø50X40 | 280.71.FFE.Y | 049 | - | - | - | 219 |
| 1 | NUDO | MESA Ø70X35<br>TABLE Ø70X35<br>TABLE Ø70X35 | 280.71.HHD.Y | 002 | - | - | - | 248 |

Float pag 33

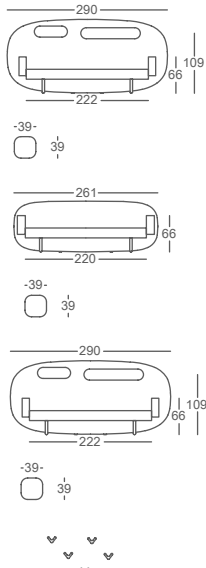

| UNI. | MOD.  | DESCRIPCIÓN / DESCRIPTION / DESCRIPTION                               | REF.      | ACABADO FINISHES FINITION | TELAS FABRIC TISSUS | SERIES | MUESTRARIO SAMPLE | PUNTOS POINTS POINTS |
|------|-------|-----------------------------------------------------------------------|-----------|---------------------------|---------------------|--------|-------------------|----------------------|
| 1    | FLOAT | RESPALDO 290<br>BACK 290<br>DOSSIER 290                               | 281.1A.Z6 | 002                       | 1623                | A      | 98                | 832                  |
| 1    | FLOAT | ASIENTO 220<br>SEAT 220<br>ASSISE 220                                 | 281.1B.Y  | 002                       | 1604                | A      | 89                | 244                  |
| 1    | FLOAT | BRAZO INCLINADO DCHO<br>INCLINED RIGHT ARM<br>BRAS INCLINÉ DROIT      | 281.13A.D | -                         | 7160                | X      | 95                | 78                   |
| 1    | FLOAT | BRAZO LARGO IZDO<br>LONG LEFT ARM<br>BRAS LONG GAUCHE                 | 281.135.I | -                         | 1643                | A      | 101               | 53                   |
| 1    | FLOAT | CABEZAL CORTO IZDO<br>LEFT SHORT HEADBOARD<br>APPUI-TÊTE COURT GAUCHE | 281.251.I | -                         | CAIRO 103           | X      | CAIRO             | 28                   |
| 1    | FLOAT | CABEZAL LARGO DCHO<br>RIGHT LARGE HEADBOARD<br>APPUI-TÊTE LONG DROIT  | 281.252.D | -                         | CAIRO 303           | X      | CAIRO             | 33                   |
| 1    | FLOAT | COJIN 39X39<br>CUSHION 39X39<br>COUSSIN 39X39                         | 281.22.DD | -                         | CAIRO 203           | X      | CAIRO             | 34                   |
| 1    | FLOAT | RESPALDO 261<br>BACK 261<br>DOSSIER 261                               | 281.1A.Z3 | 002                       | 6053                | E      | 92                | 633                  |
| 1    | FLOAT | ASIENTO 220<br>SEAT 220<br>ASSISE 220                                 | 281.1B.Y  | 002                       | 6081                | E      | 93                | 288                  |
| 1    | FLOAT | BRAZO CORTO IZDO<br>SHORT LEFT ARM<br>BRAS COURT GAUCHE               | 281.136.I | -                         | 8042                | J      | 97                | 66                   |
| 1    | FLOAT | BRAZO CORTO DCHO<br>SHORT RIGHT ARM<br>BRAS COURT DROIT               | 281.136.D | -                         | STEP 62057          | B      | STEP              | 50                   |
| 1    | FLOAT | COJIN 39X39<br>CUSHION 39X39<br>COUSSIN 39X39                         | 281.22.DD | -                         | CAIRO 106           | X      | CAIRO             | 34                   |
| 1    | FLOAT | PERCHERO PARED<br>WALL HANGER<br>PORTEMANTEAU                         | 281.38    | 042                       | -                   | -      | -                 | 38                   |
| 1    | FLOAT | PERCHERO PARED<br>WALL HANGER<br>PORTEMANTEAU                         | 281.38    | 049                       | -                   | -      | -                 | 38                   |
| 1    | FLOAT | PERCHERO PARED<br>WALL HANGER<br>PORTEMANTEAU                         | 281.38    | 045                       | -                   | -      | -                 | 38                   |
| 2    | FLOAT | PERCHERO PARED<br>WALL HANGER<br>PORTEMANTEAU                         | 281.38    | 002                       | -                   | -      | -                 | 38                   |
| 1    | FLOAT | RESPALDO 290<br>BACK 290<br>DOSSIER 290                               | 281.1A.Z6 | 002                       | 6081                | E      | 93                | 949                  |
| 1    | FLOAT | ASIENTO 220<br>SEAT 220<br>ASSISE 220                                 | 281.1B.Y  | 002                       | 6053                | E      | 92                | 288                  |
| 1    | FLOAT | BRAZO LARGO DCHO<br>LONG RIGHT ARM<br>BRAS LONG DROIT                 | 281.135.D | -                         | 6060                | E      | 92                | 61                   |
| 1    | FLOAT | BRAZO LARGO IZDO<br>LONG LEFT ARM<br>BRAS LONG GAUCHE                 | 281.135.I | -                         | 6060                | E      | 92                | 61                   |
| 1    | FLOAT | CABEZAL CORTO IZDO<br>LEFT SHORT HEADBOARD<br>APPUI-TÊTE COURT GAUCHE | 281.251.I | -                         | STEP 62057          | B      | STEP              | 25                   |
| 1    | FLOAT | CABEZAL LARGO DCHO<br>RIGHT LARGE HEADBOARD<br>APPUI-TÊTE LONG DROIT  | 281.252.D | -                         | 8042                | J      | 97                | 39                   |
| 1    | FLOAT | COJIN 39X39<br>CUSHION 39X39<br>COUSSIN 39X39                         | 281.22.DD | -                         | CAIRO 302           | X      | CAIRO             | 34                   |
| 1    | FLOAT | COJIN 39X39<br>CUSHION 39X39<br>COUSSIN 39X39                         | 281.22.DD | -                         | 6057                | E      | 92                | 39                   |

Float pag 36

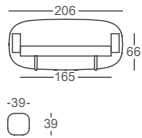

| UNL. | MOD.  | DESCRIPCIÓN / DESCRIPTION / DESCRIPTION                 | REF.      | ACABADO FINISHES FINITION | TELAS FABRIC TISSUS | SERIES | MUESTRARIO SAMPLE | PUNTOS POINTS POINTS |
|------|-------|---------------------------------------------------------|-----------|---------------------------|---------------------|--------|-------------------|----------------------|
| 1    | FLOAT | RESPALDO 261<br>BACK 261<br>DOSSIER 261                 | 281.1A.Z3 | 002                       | STEP<br>65018       | B      | STEP              | 538                  |
| 1    | FLOAT | ASIENTO 220<br>SEAT 220<br>ASSISE 220                   | 281.1B.Y  | 002                       | 6077                | E      | 93                | 288                  |
| 1    | FLOAT | BRAZO CORTO IZDO<br>SHORT LEFT ARM<br>BRAS COURT GAUCHE | 281.136.I | -                         | 8028                | J      | 94                | 66                   |
| 1    | FLOAT | BRAZO CORTO DCHO<br>SHORT RIGHT ARM<br>BRAS COURT DROIT | 281.136.D | -                         | 8028                | J      | 94                | 66                   |
| 1    | FLOAT | COJIN 39X39<br>CUSHION 39X39<br>COUSSIN 39X39           | 281.22.DD | -                         | CAIRO 203           | X      | CAIRO             | 34                   |

Float pag 38-39

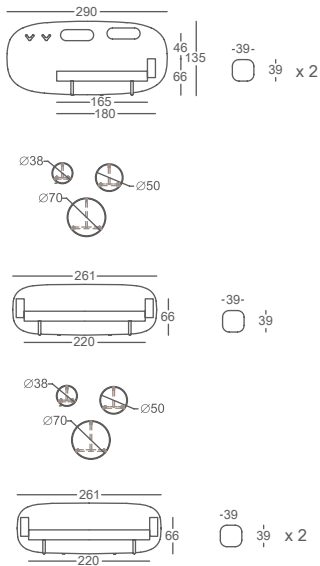

| UNL. | MOD.  | DESCRIPCIÓN / DESCRIPTION / DESCRIPTION                                                             | REF.          | ACABADO FINISHES FINITION | TELAS FABRIC TISSUS | SERIES | MUESTRARIO SAMPLE | PUNTOS POINTS POINTS |
|------|-------|-----------------------------------------------------------------------------------------------------|---------------|---------------------------|---------------------|--------|-------------------|----------------------|
| 1    | FLOAT | RESPALDO 290 CON PERCHERO IZDO<br>BACK 290 WITH LEFT HANGER<br>DOSSIER 290 AVEC PORTEMANTEAU GAUCHE | 281.1A.Z6.P.I | 045                       | STEP<br>60004       | B      | STEP              | 884                  |
| 1    | FLOAT | ASIENTO 165<br>SEAT 165<br>ASSISE 165                                                               | 281.1B.S      | 045                       | 7163                | X      | 95                | 217                  |
| 1    | FLOAT | BRAZO LARGO DCHO<br>LONG RIGHT ARM<br>BRAS LONG DROIT                                               | 281.135.D     | -                         | 6058                | E      | 92                | 61                   |
| 1    | FLOAT | CABEZAL CORTO IZDO<br>LEFT SHORT HEADBOARD<br>APPUI-TÊTE COURT GAUCHE                               | 281.251.I     | -                         | CAIRO 101           | X      | CAIRO             | 28                   |
| 1    | FLOAT | CABEZAL CORTO DCHO<br>RIGHT SHORT HEADBOARD<br>APPUI-TÊTE COURT DROIT                               | 281.251.D     | -                         | CAIRO 105           | X      | CAIRO             | 28                   |
| 1    | FLOAT | COJIN 39X39<br>CUSHION 39X39<br>COUSSIN 39X39                                                       | 281.22.DD     | -                         | CAIRP 304           | X      | CAIRO             | 34                   |
| 1    | FLOAT | COJIN 39X39<br>CUSHION 39X39<br>COUSSIN 39X39                                                       | 281.22.DD     | -                         | CAIRO 101           | X      | CAIRO             | 34                   |
| 1    | NUDO  | MESA Ø38X45<br>TABLE Ø38X45<br>TABLE Ø38X45                                                         | 280.71.DDE.Y  | 002                       | -                   | -      | -                 | 184                  |
| 1    | NUDO  | MESA Ø50X40<br>TABLE Ø50X40<br>TABLE Ø50X40                                                         | 280.71.FFE.Y  | 002                       | -                   | -      | -                 | 209                  |
| 1    | NUDO  | MESA Ø70X35<br>TABLE Ø70X35<br>TABLE Ø70X35                                                         | 280.71.HHD.Y  | 049                       | -                   | -      | -                 | 292                  |
| 1    | FLOAT | RESPALDO 261<br>BACK 261<br>DOSSIER 261                                                             | 281.1A.Z3     | 002                       | 6053                | E      | 92                | 633                  |
| 1    | FLOAT | ASIENTO 220<br>SEAT 220<br>ASSISE 220                                                               | 281.1B.Y      | 002                       | 6081                | E      | 93                | 288                  |
| 1    | FLOAT | BRAZO CORTO IZDO<br>SHORT LEFT ARM<br>BRAS COURT GAUCHE                                             | 281.136.I     | -                         | 8042                | J      | 97                | 66                   |
| 1    | FLOAT | BRAZO CORTO DCHO<br>SHORT RIGHT ARM<br>BRAS COURT DROIT                                             | 281.136.D     | -                         | STEP<br>62057       | B      | STEP              | 50                   |
| 1    | FLOAT | COJIN 39X39<br>CUSHION 39X39<br>COUSSIN 39X39                                                       | 281.22.DD     | -                         | CAIRO 203           | X      | CAIRO             | 34                   |
| 1    | NUDO  | MESA Ø38X45<br>TABLE Ø38X45<br>TABLE Ø38X45                                                         | 280.71.DDE.Y  | 002                       | -                   | -      | -                 | 184                  |
| 1    | NUDO  | MESA Ø50X40<br>TABLE Ø50X40<br>TABLE Ø50X40                                                         | 280.71.FFE.Y  | 002                       | -                   | -      | -                 | 209                  |
| 1    | NUDO  | MESA Ø70X35<br>TABLE Ø70X35<br>TABLE Ø70X35                                                         | 280.71.HHD.Y  | 002                       | -                   | -      | -                 | 248                  |
| 1    | FLOAT | RESPALDO 261<br>BACK 261<br>DOSSIER 261                                                             | 281.1A.Z3     | 042                       | STEP<br>60004       | B      | STEP              | 538                  |
| 1    | FLOAT | ASIENTO 220<br>SEAT 220<br>ASSISE 220                                                               | 281.1B.Y      | 042                       | STEP<br>60004       | B      | STEP              | 232                  |
| 1    | FLOAT | BRAZO CORTO IZDO<br>SHORT LEFT ARM<br>BRAS COURT GAUCHE                                             | 281.136.I     | -                         | STEP<br>62056       | B      | STEP              | 50                   |

|   |       |                                                         |           |               |   |       |    |
|---|-------|---------------------------------------------------------|-----------|---------------|---|-------|----|
| 1 | FLOAT | BRAZO CORTO DCHO<br>SHORT RIGHT ARM<br>BRAS COURT DROIT | 281.136.D | STEP<br>62056 | B | STEP  | 50 |
| 1 | FLOAT | COJIN 39X39<br>CUSHION 39X39<br>COUSSIN 39X39           | 281.22.DD | CAIRO 202     | X | CAIRO | 34 |
| 1 | FLOAT | COJIN 39X39<br>CUSHION 39X39<br>COUSSIN 39X39           | 281.22.DD | CAIRO 102     | X | CAIRO | 34 |

Copla pag 46-47

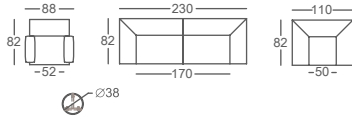

| UNL. | MOD.  | DESCRIPCIÓN / DESCRIPTION / DESCRIPTION                               | REF.         | ACABADO FINISHES FINITION | TELAS FABRIC TISSUS | SERIES | MUESTRARIO SAMPLE | PUNTOS POINTS POINTS |
|------|-------|-----------------------------------------------------------------------|--------------|---------------------------|---------------------|--------|-------------------|----------------------|
| 1    | COPLA | SILLON 88 BR BAJO<br>ARMCHAIR 88 LOW ARM<br>FAUTEUIL 88 BRAS BAS      | 278.11.J.J   | 002                       | STEP<br>67007       | B      | STEP              | 487                  |
| 1    | COPLA | SOFA 230 BR ALTO<br>SOFA 230 HIGH ARM<br>CANAPE 230 BRAS HAUT         | 278.11.Z.3   | 002                       | 1623                | A      | 98                | 974                  |
| 1    | COPLA | SILLON 110 BR ALTO<br>ARMCHAIR 110 HIGH ARM<br>FAUTEUIL 110 BRAS HAUT | 278.11.M.3   | 002                       | STEP<br>68118       | B      | STEP              | 569                  |
| 1    | NUDO  | MESA Ø38X45<br>TABLE Ø38X45<br>TABLE Ø38X45                           | 280.71.DDE.Y | 042                       | -                   | -      | -                 | 192                  |

Copla pag 48-49

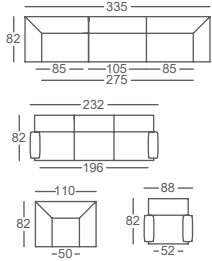

| UNL. | MOD.  | DESCRIPCIÓN / DESCRIPTION / DESCRIPTION                               | REF.         | ACABADO FINISHES FINITION | TELAS FABRIC TISSUS | SERIES | MUESTRARIO SAMPLE | PUNTOS POINTS POINTS |
|------|-------|-----------------------------------------------------------------------|--------------|---------------------------|---------------------|--------|-------------------|----------------------|
| 1    | COPLA | SOFA 335 BR ALTO<br>SOFA 335 HIGH ARM<br>CANAPE 335 BRAS HAUT         | 278.11.Z92.3 | 002                       | 8034                | J      | 97                | 1524                 |
| 1    | COPLA | SOFA 232 BR BAJO<br>SOFA 232 LOW ARM<br>CANAPE 232 BRAS BAS           | 278.11.Z.J   | 002                       | 6055                | E      | 92                | 1135                 |
| 1    | COPLA | SILLON 110 BR ALTO<br>ARMCHAIR 110 HIGH ARM<br>FAUTEUIL 110 BRAS HAUT | 278.11.M.3   | 002                       | STEP<br>68118       | B      | STEP              | 569                  |
| 1    | COPLA | SILLON 88 BR BAJO<br>ARMCHAIR 88 LOW ARM<br>FAUTEUIL 88 BRAS BAS      | 278.11.J.J   | 002                       | STEP<br>67007       | B      | STEP              | 487                  |

Copla pag 50-51

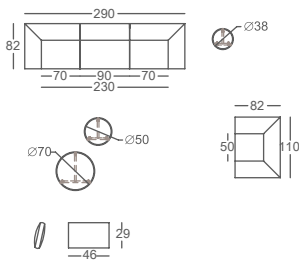

| UNL. | MOD.   | DESCRIPCIÓN / DESCRIPTION / DESCRIPTION                                    | REF.         | ACABADO FINISHES FINITION | TELAS FABRIC TISSUS | SERIES | MUESTRARIO SAMPLE | PUNTOS POINTS POINTS |
|------|--------|----------------------------------------------------------------------------|--------------|---------------------------|---------------------|--------|-------------------|----------------------|
| 1    | COPLA  | SOFA 290 BR ALTO<br>SOFA 290 HIGH ARM<br>CANAPE 290 BRAS HAUT              | 278.11.Z6.3  | 041                       | STEP<br>68120       | B      | STEP              | 1156                 |
| 1    | COPLA  | SILLON 110 BR ALTO<br>ARMCHAIR 110 HIGH ARM<br>FAUTEUIL 110 BRAS HAUT      | 278.11.M.3   | 002                       | STEP<br>68118       | B      | STEP              | 569                  |
| 1    | LINEAL | ALMOHADA RINONERA 46X29<br>LUMBAR CUSHION 46X29<br>COUSSIN CALE REIN 46X29 | 238.27.EC    | -                         | 3870                | C      | 102               | 32                   |
| 1    | NUDO   | MESA Ø38X45<br>TABLE Ø38X45<br>TABLE Ø38X45                                | 280.71.DDE.Y | 041                       | -                   | -      | -                 | 192                  |
| 1    | NUDO   | MESA Ø50X40<br>TABLE Ø50X40<br>TABLE Ø50X40                                | 280.71.FFE.Y | 002                       | -                   | -      | -                 | 209                  |
| 1    | NUDO   | MESA Ø70X35<br>TABLE Ø70X35<br>TABLE Ø70X35                                | 280.71.HHD.Y | 002                       | -                   | -      | -                 | 248                  |

Copla pag 52-53

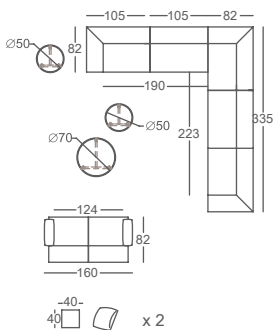

| UNL. | MOD.  | DESCRIPCIÓN / DESCRIPTION / DESCRIPTION                                   | REF.         | ACABADO FINISHES FINITION | TELAS FABRIC TISSUS | SERIES | MUESTRARIO SAMPLE | PUNTOS POINTS POINTS |
|------|-------|---------------------------------------------------------------------------|--------------|---------------------------|---------------------|--------|-------------------|----------------------|
| 1    | COPLA | SOFA 335 BR ALTO<br>SOFA 335 HIGH ARM<br>CANAPE 335 BRAS HAUT             | 278.11.Z92.3 | 002                       | 8034                | J      | 97                | 1524                 |
| 1    | COPLA | MODULO 105<br>MODULE 105<br>MODULE 105                                    | 278.12.L     | 002                       | 8034                | J      | 97                | 414                  |
| 1    | COPLA | MOD 115 BR ALTO IZDO<br>MOD 115 HIGH LEFT ARM<br>MOD 115 BRAS HAUT GAUCHE | 278.12.M.3.I | 002                       | 8034                | J      | 97                | 577                  |
| 1    | COJIN | COJIN DECORACION 40X40<br>CUSHION 40X40<br>COUSSIN 40X40                  | 100.22.DD    | -                         | 8042                | J      | 97                | 36                   |
| 1    | COJIN | COJIN DECORACION 40X40<br>CUSHION 40X40<br>COUSSIN 40X40                  | 100.22.DD    | -                         | 8045                | J      | 97                | 36                   |

|   |       |                                                                  |               |     |      |   |         |     |
|---|-------|------------------------------------------------------------------|---------------|-----|------|---|---------|-----|
| 1 | COPLA | SOFA 160 BR BAJO<br>SOFA 160 LOW ARM<br>CANAPE 160 BRAS BAS      | 278.11.R.J    | 002 | 6055 | E | 92      | 846 |
| 1 | NUDO  | MESA Ø50X40<br>TABLE Ø50X40<br>TABLE Ø50X40                      | 280.71.FFE.Y  | 049 | -    | - | -       | 219 |
| 1 | NUDO  | MESA Ø50X40 MARMOL<br>TABLE Ø50X40 MARBLE<br>TABLE Ø50X40 MARBRE | 280.71.FFE.A6 | 107 | -    | - | CARRARA | 242 |
| 1 | NUDO  | MESA Ø70X35<br>TABLE Ø70X35<br>TABLE Ø70X35                      | 280.71.HHD.Y  | 051 | -    | - | -       | 261 |

Copla pag 54-55

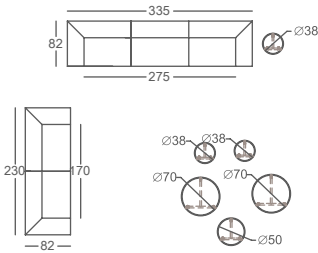

| UNL. | MOD.  | DESCRIPCIÓN / DESCRIPTION / DESCRIPTION                       | REF.         | ACABADO FINISHES FINITION | TELAS FABRIC TISSUS | SERIES | MUESTRARIO SAMPLE | PUNTOS POINTS POINTS |
|------|-------|---------------------------------------------------------------|--------------|---------------------------|---------------------|--------|-------------------|----------------------|
| 1    | COPLA | SOFA 335 BR ALTO<br>SOFA 335 HIGH ARM<br>CANAPE 335 BRAS HAUT | 278.11.Z92.3 | 002                       | 8034                | J      | 97                | 1524                 |
| 1    | COPLA | SOFA 230 BR ALTO<br>SOFA 230 HIGH ARM<br>CANAPE 230 BRAS HAUT | 278.11.Z.3   | 002                       | 1623                | A      | 98                | 974                  |
| 1    | NUDO  | MESA Ø38X45<br>TABLE Ø38X45<br>TABLE Ø38X45                   | 280.71.DDE.Y | 002                       | -                   | -      | -                 | 184                  |
| 1    | NUDO  | MESA Ø38X45<br>TABLE Ø38X45<br>TABLE Ø38X45                   | 280.71.DDE.Y | 042                       | -                   | -      | -                 | 192                  |
| 1    | NUDO  | MESA Ø38X45<br>TABLE Ø38X45<br>TABLE Ø38X45                   | 280.71.DDE.Y | 045                       | -                   | -      | -                 | 192                  |
| 1    | NUDO  | MESA Ø50X40<br>TABLE Ø50X40<br>TABLE Ø50X40                   | 280.71.FFE.Y | 002                       | -                   | -      | -                 | 209                  |
| 1    | NUDO  | MESA Ø70X35<br>TABLE Ø70X35<br>TABLE Ø70X35                   | 280.71.HHD.Y | 049                       | -                   | -      | -                 | 261                  |
| 1    | NUDO  | MESA Ø70X35<br>TABLE Ø70X35<br>TABLE Ø70X35                   | 280.71.HHD.Y | 043                       | -                   | -      | -                 | 261                  |

Copla pag 56-57

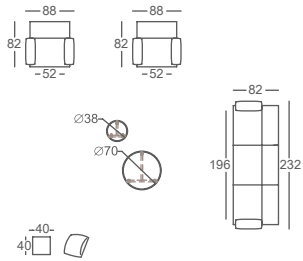

| UNL. | MOD.                  | DESCRIPCIÓN / DESCRIPTION / DESCRIPTION                          | REF.         | ACABADO FINISHES FINITION | TELAS FABRIC TISSUS | SERIES | MUESTRARIO SAMPLE | PUNTOS POINTS POINTS |
|------|-----------------------|------------------------------------------------------------------|--------------|---------------------------|---------------------|--------|-------------------|----------------------|
| 1    | COPLA                 | SOFA 232 BR BAJO<br>SOFA 232 LOW ARM<br>CANAPE 232 BRAS BAS      | 278.11.Z.J   | 002                       | 6055                | E      | 92                | 1135                 |
| 2    | COPLA                 | SILLON 88 BR BAJO<br>ARMCHAIR 88 LOW ARM<br>FAUTEUIL 88 BRAS BAS | 278.11.J.J   | 002                       | STEP 67007          | B      | STEP              | 487                  |
| 1    | NUDO                  | MESA Ø38X45<br>TABLE Ø38X45<br>TABLE Ø38X45                      | 280.71.DDE.Y | 002                       | -                   | -      | -                 | 184                  |
| 1    | NUDO                  | MESA Ø70X35<br>TABLE Ø70X35<br>TABLE Ø70X35                      | 280.71.HHD.Y | 002                       | -                   | -      | -                 | 248                  |
| 1    | COJIN CUSHION COUSSIN | COJIN DECORACION 40X40<br>CUSHION 40X40<br>COUSSIN 40X40         | 100.22.DD    | -                         | 8042                | J      | 97                | 36                   |

Nudo pag 70-71

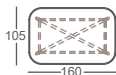
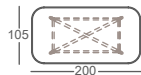

| UNI. | MOD. | DESCRIPCIÓN / DESCRIPTION / DESCRIPTION                          | REF.          | ACABADO<br>FINISHES<br>FINITION | PUNTOS<br>POINTS<br>POINTS |
|------|------|------------------------------------------------------------------|---------------|---------------------------------|----------------------------|
| 1    | NUDO | MESA 200X100X74<br>TABLE 200X100X74<br>TABLE 200X100X74          | 280.74.WLH    | 049                             | 698                        |
| 1    | NUDO | MESA Ø38X45<br>TABLE Ø38X45<br>TABLE Ø38X45                      | 280.71.DDE.Y  | 049                             | 192                        |
| 1    | NUDO | MESA Ø50X40 MARMOL<br>TABLE Ø50X40 MARBLE<br>TABLE Ø50X40 MARBRE | 280.71.FFE.A6 | CARRARA/107                     | 242                        |
| 1    | NUDO | MESA Ø70X35 MARMOL<br>TABLE Ø70X35 MARBLE<br>TABLE Ø70X35 MARBRE | 280.71.HHD.A6 | MARQUINA/108                    | 292                        |
| 1    | NUDO | MESA 160X100X74<br>TABLE 160X100X74<br>TABLE 160X100X74          | 280.74.SLH    | 002                             | 609                        |
| 1    | NUDO | MESA Ø38X45<br>TABLE Ø38X45<br>TABLE Ø38X45                      | 280.71.DDE.Y  | 041                             | 192                        |
| 1    | NUDO | MESA Ø50X40<br>TABLE Ø50X40<br>TABLE Ø50X40                      | 280.71.FFE.Y  | 002                             | 209                        |
| 1    | NUDO | MESA Ø70X35<br>TABLE Ø70X35<br>TABLE Ø70X35                      | 280.71.HHD.Y  | 043                             | 261                        |
| 1    | NUDO | MESA 110X110X74<br>TABLE 110X110X74<br>TABLE 110X110X74          | 280.74.MMH    | 002/051                         | 556                        |
| 1    | NUDO | MESA Ø38X45<br>TABLE Ø38X45<br>TABLE Ø38X45                      | 280.71.DDE.Y  | 042                             | 192                        |
| 1    | NUDO | MESA Ø50X40<br>TABLE Ø50X40<br>TABLE Ø50X40                      | 280.71.FFE.Y  | 051                             | 219                        |
| 1    | NUDO | MESA Ø70X35<br>TABLE Ø70X35<br>TABLE Ø70X35                      | 280.71.HHD.Y  | 002                             | 248                        |



## CALIDAD

La satisfacción de nuestros clientes y la calidad de nuestros productos es un elemento central en la política de Sancal, por ello la empresa apuesta por la Mejora Continua a través de un riguroso Sistema de Gestión de la Calidad que se rige por las normativas ISO 9000 y es anualmente supervisado por Bureau Veritas. Además, la calidad de nuestros productos está garantizada por el saber hacer de nuestro personal y por la supervisión directa de una fabricación made in Spain.

## ENSAYOS

Sancal ensaya sus productos en los laboratorios de CETEM y/o de AIDIMA según las normativas UNE (Española) y UNE EN (Europea) para usos en espacios públicos.

El Símbolo Calidad Controlada certifica a aquellos muebles que han superado diferentes ensayos y reconoce que son adecuados para el uso al que están destinados.

Los test específicos a los que son sometidos nuestros productos comprueban la Durabilidad; la Estabilidad; la Resistencia estática; la Resistencia a impactos y caídas y la Seguridad de los mismos.

Según el tipo de productos las normas que aplicamos son:

| <b>ASIENTOS</b>         |                                                           |
|-------------------------|-----------------------------------------------------------|
| <b>Sofás y bancadas</b> |                                                           |
| Norma ensayo            | UNE 11012:1989                                            |
| Norma especificación    | UNE 11021-2 Nivel 4/5:1992<br>(uso público normal/severo) |
| Norma ensayo            | UNE EN 15373:2007                                         |
| Norma especificación    | UNE EN 15373:2007<br>Nivel 2 (uso no doméstico general)   |
| <b>Sillas y butacas</b> |                                                           |
| Norma ensayo            | UNE 11010:1989                                            |
| Norma especificación    | UNE 11020-2 Nivel 4/5:1992<br>(uso público normal/severo) |
| Norma ensayo            | UNE EN 15373:2007                                         |
| Norma especificación    | UNE EN 15373:2007<br>Nivel 2 (uso no doméstico general)   |
| <b>MESAS</b>            |                                                           |
| Norma ensayo            | UNE 11014:1989                                            |
| Norma especificación    | UNE 11022.2 Nivel 4/5:1992<br>(uso público normal/severo) |

## ECOLOGÍA

La conservación del medio ambiente nos preocupa y ha preocupado desde la fundación de la empresa. El consumo sostenible es nuestra máxima y el reciclaje es una realidad para todo el personal de Sancal. Asimismo el tratamiento que damos a nuestros residuos cumple con las normativas europeas correspondientes y la madera empleada en nuestros productos proviene de bosques renovables. La Región de Murcia ha concedido a Sancal el distintivo de Empresa Comprometida con el Desarrollo Sostenible.

**A partir de 2010 esta filosofía se consolida con la ISO 14001 a través de un riguroso Sistema de Gestión Medioambiental.**

## GARANTÍAS

Sancal garantiza todos sus productos hasta 2 años a partir de la fecha de compra indicada en la factura.

Estas garantías son válidas exclusivamente cuando el producto es empleado en aquellas actividades para las que fue concebido. La garantía queda revocada automáticamente en caso de un uso inapropiado del producto o de la manipulación de los componentes del mismo.

## QUALITY

The main aim of Sancal's policy is to achieve customer satisfaction and quality products, thus the firm implements Ongoing Improvements through a thorough System of Quality Management ruled by the ISO 9000 standard and it is annually supervised by Bureau Veritas. Moreover, quality is guaranteed by our personnel's know-how and the direct monitoring of our manufactured products, which bear the made in Spain guarantee.

## TESTS

Sancal tests its products in the CETEM and/or AIDIMA laboratories depending on the UNE (Spanish) and UNE EN (European) standard for use in public spaces.

The Quality Controlled Symbol certifies all pieces of furniture that have passed different tests and recognises that they are suitable for the use for which they were designed.

The specific tests to which our products are subject to check: durability; stability; static resistance; resistance to impacts and its security.

Depending on the type of products, the standards applied are:

| <b>SEATS</b>                     |                                                         |
|----------------------------------|---------------------------------------------------------|
| <b>Sofas and benches</b>         |                                                         |
| Test rule                        | UNE 11012:1989                                          |
| Specification rule               | UNE 11021-2 Nivel 4/5:1992<br>(normal/harsh public use) |
| Test rule                        | UNE EN 15373:2007                                       |
| Specification rule               | UNE EN 15373:2007<br>Nivel 2 (non domestic general use) |
| <b>Sofas and small armchairs</b> |                                                         |
| Test rule                        | UNE 11010:1989                                          |
| Specification rule               | UNE 11020-2 Nivel 4/5:1992<br>(normal/harsh public use) |
| Test rule                        | UNE EN 15373:2007                                       |
| Especificaction rule             | UNE EN 15373:2007<br>Nivel 2 (domestic use)             |
| <b>TABLES</b>                    |                                                         |
| Standard rule                    | UNE 11014:1989                                          |
| Specification rule               | UNE 11022.2 Nivel 4/5:1992<br>(normal/harsh public use) |

## ECOLOGY

We are concerned with environmental conservation, and have been since the company was established. Sustainable consumption is our motto and recycling is a reality for all Sancal personnel. The treatment we give our resources complies with the relevant European regulations, and the wood used in our products comes from renewable forests. The Region of Murcia has conferred distinction on Sancal as a Company Committed to Sustained Development. From 2010 this philosophy was consolidated with the ISO 14001 through a rigorous Environmental Management System.

## GUARANTEES

Sancal guarantees all its products for up to 2 years from the purchase date stated on the invoice. These guarantees are only valid when the product is used in those applications for which it was made. Guarantee will be automatically revoked in the event of inappropriate product use.

## QUALITE

La satisfaction de nos clients et la qualité de nos produits sont des facteurs primordiaux dans notre politique. Pour cela, Sancal s'engage à l'amélioration continue au travers de systèmes de gestion et de qualité rigoureux, régis par les normes ISO 9000, et annuellement vérifiés par le Bureau Veritas. De plus, la qualité de nos produits est garantie par le savoir-faire de notre personnel et la qualité de fabrication Made in Spain.

## ECOLOGIE

La préservation de la nature nous préoccupe et a toujours préoccupé l'usine depuis sa création. La consommation limitée est notre devise et le recyclage est une réalité pour tout notre personnel. Ainsi le traitement appliqué à nos résidus est en accord total avec les lois normes européennes et le bois employé dans nos produits provient de forêt renouvelables. Actuellement, nous sommes sous procès de certification ISO14001 et grâce à notre travail écologique, la région de Murcia nous a décerné le titre d'Entreprise Engagée pour le Développement Durable. Cette Philosophie se consolide depuis 2010 avec la certification ISO 14001, au travers d'un rigoureux Système de Gestion de l'Environnement.

## GARANTIE

Sancal garantit tous ses produits 2 ans et jusqu'à 10 ans pour les structures en bois de ses canapés, à partir de la date d'achat indiquée sur la facture. Ces garanties sont valides uniquement si le produit a subi une utilisation conforme à celle pour lequel il était destiné. La garantie est automatiquement révoquée dans le cas d'une utilisation non adaptée.

## TESTS PRODUITS

Sancal teste ses produits dans des laboratoires du CETEM et/ou de l'AIDIMA selon les normes UNE (espagnole) et UNE EN (européenne) pour des utilisations en espaces publics. Le Symbole Qualité Contrôlée certifie que les meubles ayant subi les différents tests sont bien adaptés à l'utilisation à laquelle ils sont destinés. Les tests spécifiques auxquels sont soumis les produits vérifient leur durabilité, leur stabilité, la résistance statique, la résistance aux impacts et aux chutes, et la sécurité des produits.

Selon le type de produit, les normes que nous appliquons sont:

| <b>ASSISES</b>               |                                                                       |
|------------------------------|-----------------------------------------------------------------------|
| <b>Canapes et banquettes</b> |                                                                       |
| Norme espagnole              | UNE 11012: 1989                                                       |
| Spécification                | UNE 11021-2 Niveau 4/5: 1992<br>(utilisation publique normale/sévère) |
| Norme européenne             | UNE EN 15373:2007                                                     |
| Spécification                | UNE EN 15373:2007<br>Niveau 2 (utilisation non domestique)            |
| <b>Chaises et fauteuils</b>  |                                                                       |
| Norme espagnole              | UNE 11010: 1989                                                       |
| Spécification                | UNE 11020-2 Nivel 4/5: 1992<br>(utilisation publique normale/sévère)  |
| Norme européenne             | UNE EN 15373:2007                                                     |
| Spécification                | UNE EN 15373:2007<br>Niveau 2 (utilisation non domestique)            |
| <b>TABLES</b>                |                                                                       |
| Norme                        | UNE 11014: 1989                                                       |
| Spécification                | UNE 11022.2 Niveau 4/5: 1992<br>(utilisation publique normale/sévère) |

# **SANCAL**

REF. 12019

**Art direction & styling** Juan Ibáñez - Elena Castaño-López

**Photography** Marcelo Martínez

**Making of** Cristobal Martínez

**Coordination** Esther Castaño-López

**Graphic project** Juan Ibáñez

**Illustration** Elena Castaño-López

Print Gráficas Vernetta

Copyright © Sancal Diseño S.L. 2012

## **Thanks To:**

Nomon

Luzifer

## **Special thanks to:**

Alberto Sanchez

Ariadna Castaño

Cristobal Martínez

Laura Candela

Nati Ortiz

Salva Marín

Sara Candela

SANCAL DISEÑO, S.L.

Pol. Ind. La Herrada C/ Príncipe de Asturias, 18

30510 Yecla (Murcia) Spain

Tel Esp. +34 968 75 15 03

Tel. Eng. +34 968 71 90 62

Tel. Fra. +34 968 71 90 61

Fax +34 968 79 40 62

e-mail [web@sancal.com](mailto:web@sancal.com)

**[www.sancal.com](http://www.sancal.com)**

