

Tavoli/Tables/Tables

design Mario Mazzer

NEW017

VERSIONI E MATERIALI

Tavoli con struttura in frassino o acciaio verniciato.
Piani in legno o multistrato, uso interno o esterno





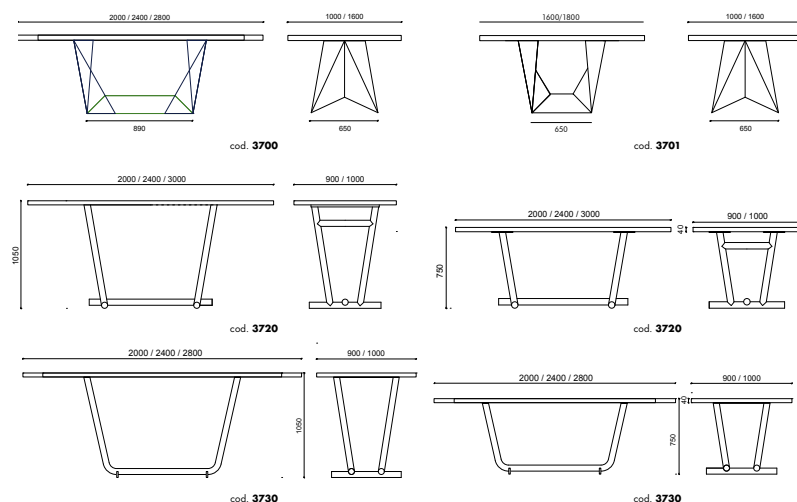

VERSIONS AND MATERIALS

Tables with ash wood frame or painted steel.
Tops in wood or laminate, indoor or outdoor use.

VERSIONS ET MATÉRIAUX

Tables avec structure en frêne solid ou acier verni.
Plateaux en bois ou laminé, usage interne ou externe



ARTICOLO article article	DESCRIZIONE description description		M ³	N.	TOT. KG BOX
3700	CLINT TAVOLO CON PIANO IN LEGNO E STRUTTURA IN ACCIAIO H 750 MM, PIEDE 890 MM Table with wood top and steel frame h 750 mm, foot 890 mm Table avec plateau en bois et structure en acier h 750 mm, pied 890 mm			1	
3701	CLINT TAVOLO CON PIANO IN LEGNO E STRUTTURA IN ACCIAIO H 750 MM, PIEDE 650 MM Table with wood top and steel frame h 750 mm, foot 650 mm Table avec plateau en bois et structure en acier h 750 mm, pied 650 mm			1	
3720	WOODBIDGE TAVOLO CON PIANO E STRUTTURA IN LEGNO H 750 MM Table with top and frame in wood h 750 mm Table avec plateau et structure en bois h 750 mm			1	
3720	WOODBIDGE TAVOLO CON PIANO E STRUTTURA IN LEGNO H 1100 MM Table with top and frame in wood h 1100 mm Table avec plateau et structure en bois h 1100 mm			1	
3730	PALOALTO TAVOLO CON PIANO IN LEGNO E STRUTTURA IN ACCIAIO VERNICIATO H 750 MM Table with wood top and painted steel frame h 750 mm Table avec plateau en bois et structure en acier verni h 750 mm			1	
3730	PALOALTO TAVOLO CON PIANO IN LEGNO E STRUTTURA IN ACCIAIO H 1100 MM Table with wood top and painted steel frame h 1100 mm Table avec plateau en bois et structure en acier verni h 1100 mm			1	

COLORI PIANO /TOP COLORS /COULEURS PLATEAU

LAMINATO /laminated /laminé	NOBILITATO /melamine /anobli	LEGNO /wood /bois
■ Pg XV	■ Pg XV	LE11 LE12 LE16 CA* ■ Pg XIV

CLINT

STRUTTURA /FRAME /STRUCTURE

METALLI
metals / métaux

VB
VNO
CE
■ Pg XIII

WOODBIDGE

STRUTTURA /FRAME /STRUCTURE

LEGNO
wood / bois

LE11
LE12
LE16
■ Pg XII

PALOALTO

STRUTTURA /FRAME /STRUCTURE

METALLI
metals / métaux

VT
VB
VS
■ Pg XIII

* SOLO PER PALOALTO /Only for Paloalto / Seulement pour Paloalto

• = INCLUSO / includes / inclus ◦ = SU RICHIESTA / on request / sur demande v = SOLO VERNICIATA o INOX / only painted or inox / seulement verni ou en inox