

Uni

Ultimo progetto di Francesco Geraci, UNI è divenuta un'icona di Metalmobil contraddistinta dalla medesima eleganza del suo progettista.

Seduta con scocca in polipropilene disponibile in 12 diversi colori (più due Pantone Color of the Year 2016) con un'ampia gamma di tipologie telai in acciaio e legno. Uni si caratterizza per l'efficace texture a effetto imbottitura sul fronte, con finitura lucida sul retro.

Dopo il successo della seduta in polipropilene, Metalmobil presenta anche la versione con imbottitura interna in poliuretano rivestita in tessuto.

Il tratto leggero ed armonioso, la perfezione delle proporzioni e la freschezza del look vengono ora ulteriormente ingentiliti grazie a questa veste. La versione imbottita è adatta a tutti i telai della collezione Uni.

The last project by Francesco Geraci, Uni has become a Metalmobil's icon with the same elegance of its designer. Polypropylene seat available in 12 different colours (plus the two Pantone Color of the Year 2016) with an extensive range of steel and wood frames. UNI stands out for its effective padded-look texture on the front and shiny finish on the back.

After the success of the polypropylene seat Metalmobil presents the version with internal padding in polyurethane covered in fabric.

The light and harmonious line, the perfection of the proportions, and the freshness of the look are now further refined thanks to this 'dress'. The padded version is suitable for all frames of the Uni collection.



Uni



VERSIONE IMBOTTITA / Upholstered version

550M



SEDIA CON SEDUTA IN POLIPROPILENE IMBOTTITA, TELAIO 4 GAMBE IN TUBO ACCIAIO.

4-leg chair with steel frame.
Polypropylene and upholstered shell.

551M



POLTRONCINA CON SEDUTA IN POLIPROPILENE IMBOTTITA, TELAIO 4 GAMBE IN TUBO ACCIAIO.

4-leg armchair with steel frame.
Polypropylene and upholstered shell.

552M



SEDIA CON SEDUTA IN POLIPROPILENE IMBOTTITA, TELAIO A SLITTA IN TONDINO ACCIAIO.

Chair with steel sled frame.
Polypropylene and upholstered shell.

552M-G



SEDIA CON SEDUTA IN POLIPROPILENE IMBOTTITA, TELAIO A SLITTA IN TONDINO ACCIAIO E SISTEMA DI AGGANCIO.

Chair with steel sled frame and connector system.
Polypropylene and upholstered shell.

MISURE

Dimensions

550M

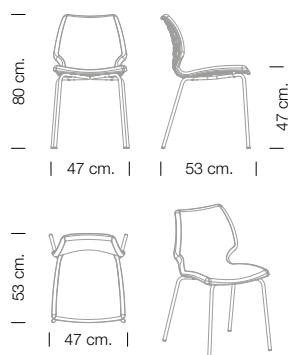

PESO
Weight
6,75 Kg

IMBALLO
Packaging
0,23 m³

PEZZI PER SCATOLA
Pieces per box
1

551M

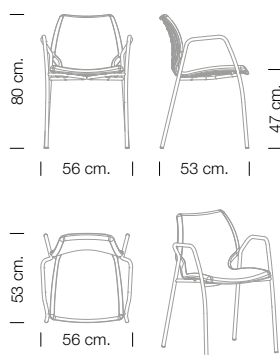

PESO
Weight
7,65 Kg

IMBALLO
Packaging
0,33 m³

PEZZI PER SCATOLA
Pieces per box
1

552M

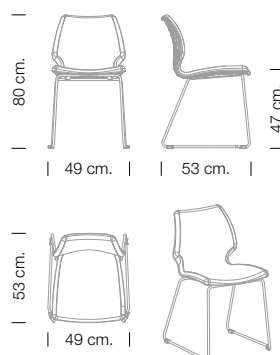

PESO
Weight
8,4 Kg

IMBALLO
Packaging
0,25 m³

PEZZI PER SCATOLA
Pieces per box
1

552M-G

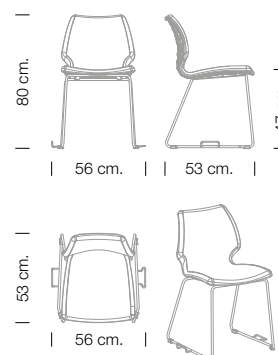

PESO
Weight
8,5 Kg

IMBALLO
Packaging
0,25 m³

PEZZI PER SCATOLA
Pieces per box
1

558M-5P



SEDIA CON SEDUTA IN POLIPROPILENE IMBOTTITA, TELAIO A 5 RAZZE IN TUBO ACCIAIO.

Swivel chair with 5 ways steel frame. Polypropylene and upholstered shell.

558M-5R



SEDIA CON SEDUTA IN POLIPROPILENE IMBOTTITA, TELAIO A 5 RAZZE IN TUBO ACCIAIO, SU RUOTE.

Swivel chair with 5 ways steel frame on castors. Polypropylene and upholstered shell.

553M



SEDIA CON SEDUTA IN POLIPROPILENE IMBOTTITA, TELAIO A TRALICCIO IN TONDINO ACCIAIO.

Chair with steel wire frame. Polypropylene and upholstered shell.

562M



SEDIA CON SEDUTA IN POLIPROPILENE IMBOTTITA, TELAIO 4 GAMBE IN LEGNO.

4-leg chair with wood frame. Polypropylene and upholstered shell.

MISURE

Dimensions

558M-5P

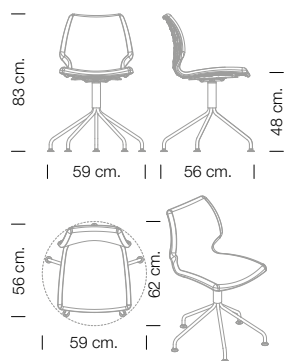

PESO
Weight
9,05 Kg

IMBALLO
Packaging
0,33 m³

PEZZI PER SCATOLA
Pieces per box
1

558M-5R

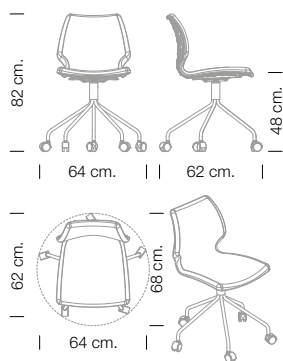

PESO
Weight
9,15 Kg

IMBALLO
Packaging
0,33 m³

PEZZI PER SCATOLA
Pieces per box
1

553M

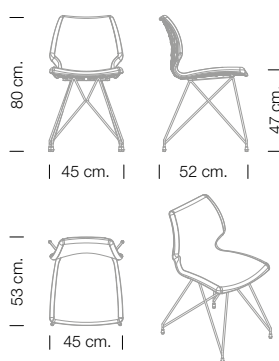

PESO
Weight
7,15 Kg

IMBALLO
Packaging
0,23 m³

PEZZI PER SCATOLA
Pieces per box
1

562M

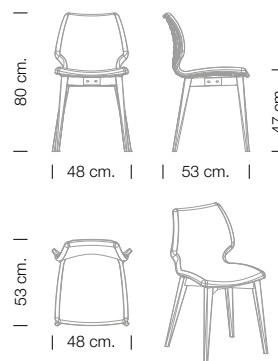

PESO
Weight
6,7 Kg

IMBALLO
Packaging
0,25 m³

PEZZI PER SCATOLA
Pieces per box
1

577M



SEDIA CON SEDUTA IN POLIPROPILENE IMBOTTITA, TELAIO 4 GAMBE TONDE IN LEGNO.

4-leg chair with round wood frame. Polypropylene and upholstered shell.

378M



SGABELLO CON SEDUTA IN POLIPROPILENE IMBOTTITA, TELAIO 4 GAMBE IN TUBO ACCIAIO.

4-leg barstool with steel frame. Polypropylene and upholstered shell.

380M



SGABELLO CON SEDUTA IN POLIPROPILENE IMBOTTITA, TELAIO A BASAMENTO CENTRALE IN ACCIAIO E MECCANISMO DI RITORNO.

Barstool with central steel base and kick-back device. Polypropylene and upholstered shell.

391M



SGABELLO CON SEDUTA IN POLIPROPILENE IMBOTTITA, TELAIO A SLITTA IN TONDINO ACCIAIO.

Barstool with steel sled frame. Polypropylene and upholstered shell.

MISURE

Dimensions

577M

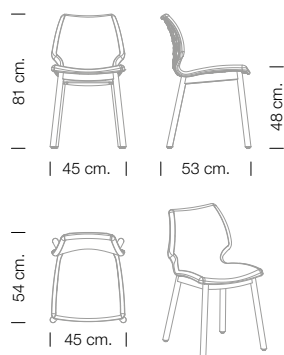

PESO
Weight
6,85 Kg

IMBALLO
Packaging
0,25 m³

PEZZI PER SCATOLA
Pieces per box
1

378M

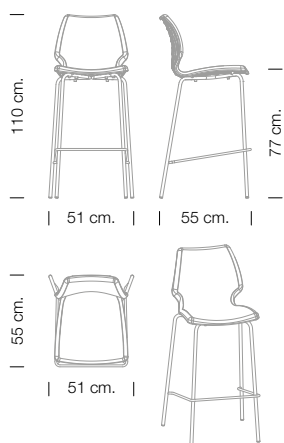

PESO
Weight
8,95 Kg

IMBALLO
Packaging
0,36 m³

PEZZI PER SCATOLA
Pieces per box
1

380M

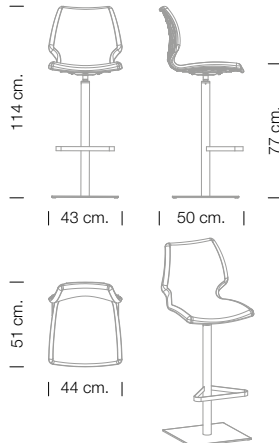

PESO
Weight
19,2 Kg

IMBALLO
Packaging
0,27 m³

PEZZI PER SCATOLA
Pieces per box
1

391M

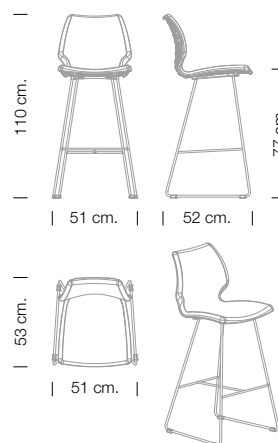

PESO
Weight
7,25 Kg

IMBALLO
Packaging
0,36 m³

PEZZI PER SCATOLA
Pieces per box
1

393M



SGABELLO CON SEDUTA IN POLIPROPILENE IMBOTTITA, TELAIO 4 GAMBE TONDE IN LEGNO.

4-leg barstool with round wood frame. Polypropylene and upholstered shell.

386M



SGABELLO CON SEDUTA IN POLIPROPILENE IMBOTTITA, TELAIO 4 GAMBE IN LEGNO.

4-leg barstool with wood frame. Polypropylene and upholstered shell.

MISURE

Dimensions

393M

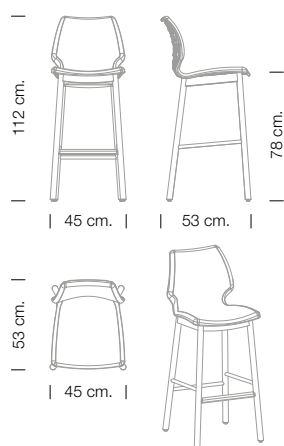

PESO
Weight
8,75 Kg

IMBALLO
Packaging
0,36 m³

PEZZI PER SCATOLA
Pieces per box
1

386M

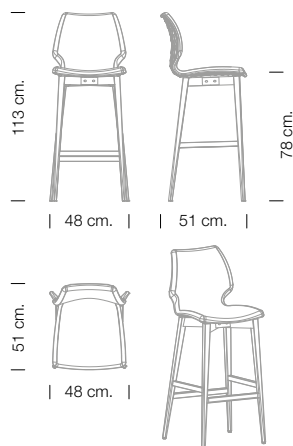

PESO
Weight
8,45 Kg

IMBALLO
Packaging
0,36 m³

PEZZI PER SCATOLA
Pieces per box
1

VERSIONE IN POLIPROPILENE / Polypropilene Version

550



SEDIA CON SEDUTA IN POLIPROPILENE, TELAIO 4 GAMBE IN TUBO ACCIAIO.

4-leg chair with steel frame. Polypropylene shell.

551



POLTRONCINA CON SEDUTA IN POLIPROPILENE, TELAIO 4 GAMBE IN TUBO ACCIAIO.

4-leg armchair with steel frame. Polypropylene shell.

552



SEDIA CON SEDUTA IN POLIPROPILENE, TELAIO A SLITTA IN TONDINO ACCIAIO.

Chair with steel sled frame. Polypropylene shell.

552-G



SEDIA CON SEDUTA IN POLIPROPILENE, TELAIO A SLITTA IN TONDINO ACCIAIO E SISTEMA DI AGGANCIO.

Chair with steel sled frame and connector system. Polypropylene shell.

MISURE

Dimensions

550

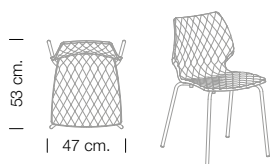

IMPILABILE
Stackable
8

PESO
Weight
4,6 Kg

IMBALLO
Packaging
0,36 m³

PEZZI PER SCATOLA
Pieces per box
5

551



IMPILABILE
Stackable
4

PESO
Weight
5,5 Kg

IMBALLO
Packaging
0,37 m³

PEZZI PER SCATOLA
Pieces per box
4

552

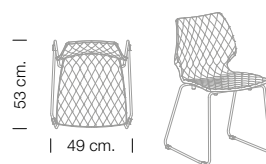
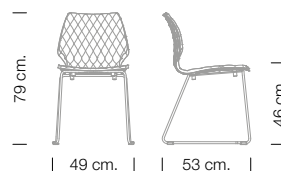

IMPILABILE
Stackable
4

PESO
Weight
6,3 Kg

IMBALLO
Packaging
0,38 m³

PEZZI PER SCATOLA
Pieces per box
4

552-G

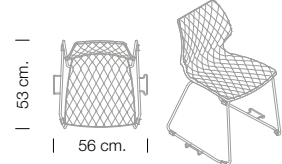
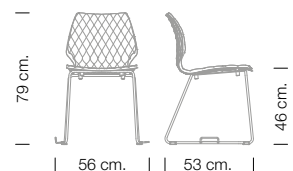

IMPILABILE
Stackable
4

PESO
Weight
6,4 Kg

IMBALLO
Packaging
0,38 m³

PEZZI PER SCATOLA
Pieces per box
4

558-5P



SEDIA CON SEDUTA IN POLIPROPILENE, TELAIO A 5 RAZZE IN TUBO ACCIAIO.

Swivel chair with 5 ways steel frame. Polypropylene shell.

558-5R



SEDIA CON SEDUTA IN POLIPROPILENE, TELAIO A 5 RAZZE IN TUBO ACCIAIO, SU RUOTE.

Swivel chair with 5 ways steel frame on castors. Polypropylene shell.

553



SEDIA CON SEDUTA IN POLIPROPILENE, TELAIO A TRALICCIO IN TONDINO ACCIAIO.

Chair with steel wire frame. Polypropylene shell.

562



SEDIA CON SEDUTA IN POLIPROPILENE, TELAIO 4 GAMBE IN LEGNO.

4-leg chair with wood frame. Polypropylene shell.

MISURE

Dimensions

558-5P

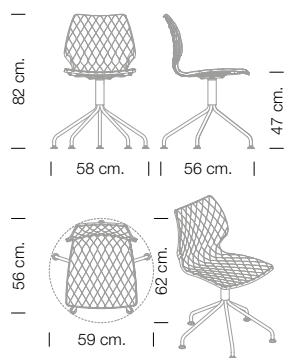

PESO
Weight
6,9 Kg

IMBALLO
Packaging
0,42 m³

PEZZI PER SCATOLA
Pieces per box
2

558-5R

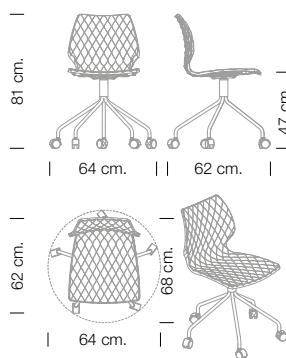

PESO
Weight
7 Kg

IMBALLO
Packaging
0,42 m³

PEZZI PER SCATOLA
Pieces per box
2

553

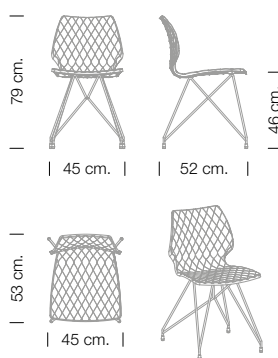

PESO
Weight
5 Kg

IMBALLO
Packaging
0,28 m³

PEZZI PER SCATOLA
Pieces per box
2

562

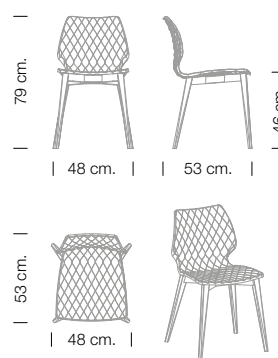

PESO
Weight
4,5 Kg

IMBALLO
Packaging
0,26 m³

PEZZI PER SCATOLA
Pieces per box
2

577



SEDIA CON SEDUTA IN POLIPROPILENE, TELAIO 4 GAMBE TONDE IN LEGNO.

4-leg chair with round wood frame. Polypropylene shell.

565



SEDIA CON SEDUTA IN POLIPROPILENE, TELAIO DA MENSA IN ACCIAIO.

Steel C-frame chair. Polypropylene shell.

544



SEDIA CON TELAIO DA MENSA IN ACCIAIO.

Chair with steel C-frame.

378



SGABELLO CON SEDUTA IN POLIPROPILENE, TELAIO 4 GAMBE IN TUBO ACCIAIO.

4-leg barstool with steel frame. Polypropylene shell.

MISURE

Dimensions

577



PESO
Weight
4,7 Kg

IMBALLO
Packaging
0,28 m³

PEZZI PER SCATOLA
Pieces per box
2

565

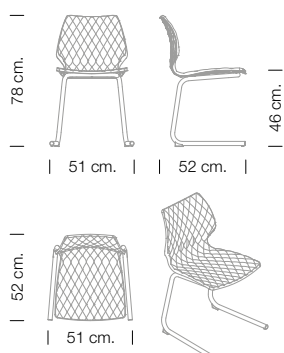

PESO
Weight
5,2 Kg

IMBALLO
Packaging
0,26 m³

PEZZI PER SCATOLA
Pieces per box
2

544

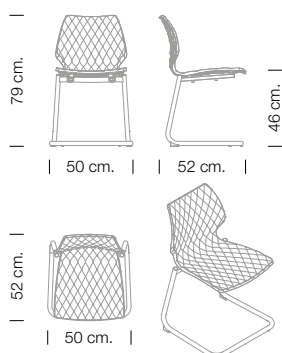

IMPILABILE
Stackable
4

PESO
Weight
6,1 Kg

IMBALLO
Packaging
0,34 m³

PEZZI PER SCATOLA
Pieces per box
4

378

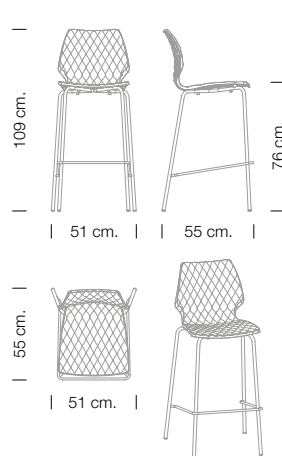

PESO
Weight
6,8 Kg

IMBALLO
Packaging
0,46 m³

PEZZI PER SCATOLA
Pieces per box
4

380



SGABELLO CON SEDUTA IN POLIPROPILENE, TELAIO A BASAMENTO CENTRALE IN ACCIAIO E MECCANISMO DI RITORNO.

Barstool with central steel base and kick-back device.
Polypropylene shell.

391



SGABELLO CON SEDUTA IN POLIPROPILENE, TELAIO A SLITTA IN TONDINO ACCIAIO.

Barstool with steel sled frame.
Polypropylene shell.

393



SGABELLO CON SEDUTA IN POLIPROPILENE, TELAIO 4 GAMBE TONDE IN LEGNO.

4-leg barstool with round wood frame.
Polypropylene shell.

386



SGABELLO CON SEDUTA IN POLIPROPILENE, TELAIO 4 GAMBE IN LEGNO.

4-leg barstool with wood frame.
Polypropylene shell.

MISURE

Dimensions

380

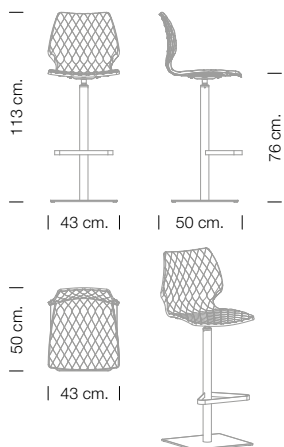

PESO
Weight
17 Kg

IMBALLO
Packaging
0,27 m³

PEZZI PER SCATOLA
Pieces per box
1

391

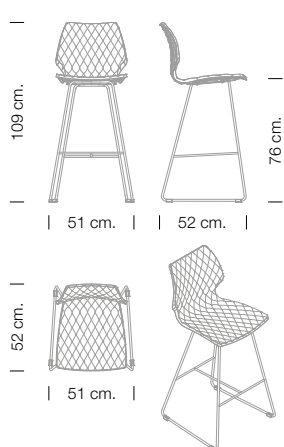

PESO
Weight
5,1 Kg

IMBALLO
Packaging
0,36 m³

PEZZI PER SCATOLA
Pieces per box
1

393

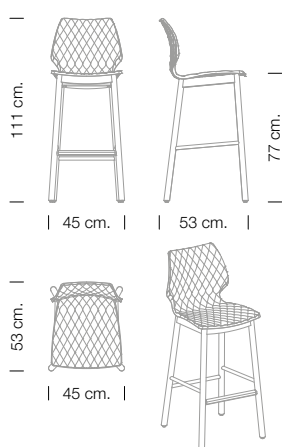

PESO
Weight
6,6 Kg

IMBALLO
Packaging
0,36 m³

PEZZI PER SCATOLA
Pieces per box
1

386

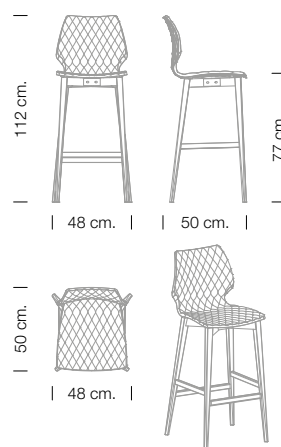

PESO
Weight
6,3 Kg

IMBALLO
Packaging
0,36 m³

PEZZI PER SCATOLA
Pieces per box
1

500



FAST FOOD CON TELAIO IN ACCIAIO.

Fast food with steel frame.

MISURE

Dimensions

500

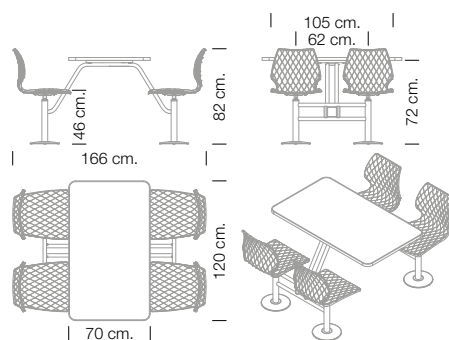

PESO

Weight
44 Kg

IMBALLO

Packaging
0,5 m³

PEZZI PER SCATOLA

Pieces per box
1

220



SISTEMA DI SEDUTE SU BARRA A DUE POSTI PIÙ PIANETTO, TELAIO IN ACCIAIO.

Steel frame bar seating system with two seats plus table.

MISURE

Dimensions

220

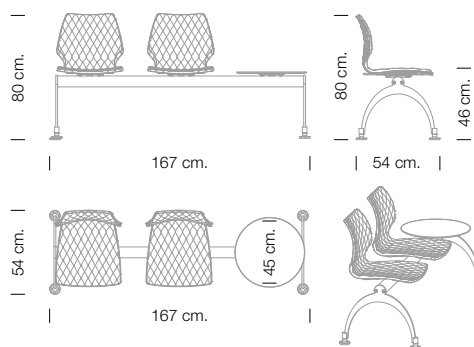

PESO

Weight
24,6 Kg

IMBALLO

Packaging
0,95 m³

PEZZI PER SCATOLA

Pieces per box
1

221



SISTEMA DI SEDUTE SU BARRA A TRE POSTI, TELAIO IN ACCIAIO.

Steel frame bar seating system with three seats.

222



SISTEMA DI SEDUTE SU BARRA A TRE POSTI PIÙ PIANETTO, TELAIO IN ACCIAIO.

Steel frame bar seating system with three seats plus table.

MISURE

Dimensions

221

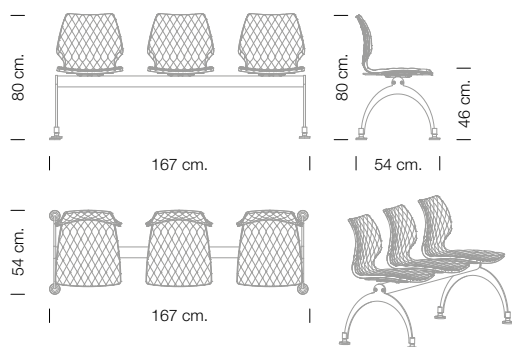

PESO

Weight
23 Kg

IMBALLO

Packaging
0,95 m³

PEZZI PER SCATOLA

Pieces per box
1

222

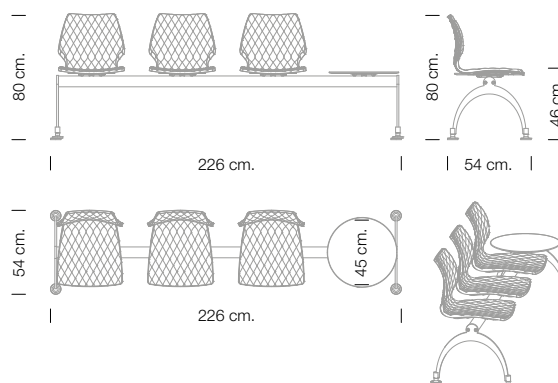

PESO

Weight
29,1 Kg

IMBALLO

Packaging
1,24 m³

PEZZI PER SCATOLA

Pieces per box
1

223



SISTEMA DI SEDUTE SU BARRA A QUATTRO POSTI
CON TELAIO IN ACCIAIO.

Steel frame bar seating system with four seats.

536



CARRELLO IN ACCIAIO
(VERNICIATO NERO).

Steel trolley (painted black).

223

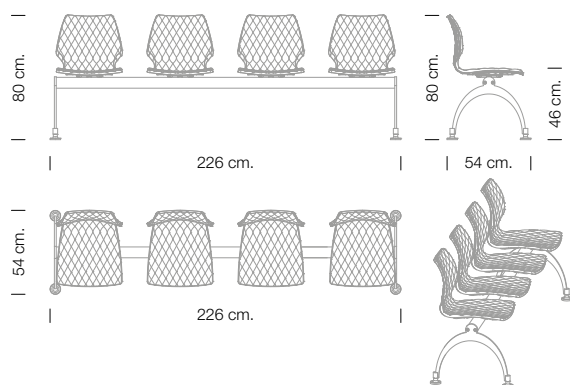

PESO
Weight
27,5 Kg

IMBALLO
Packaging
1,24 m³

PEZZI PER SCATOLA
Pieces per box
1

536

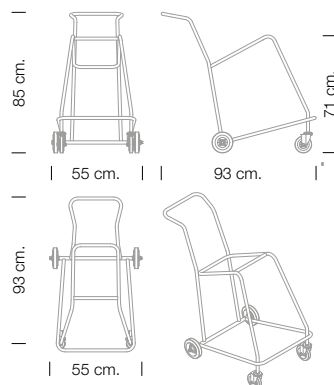

PESO
Weight
5,8 Kg

IMBALLO
Packaging
0,47 m³

PEZZI PER SCATOLA
Pieces per box
1

Finiture Sedute / Seating Finishes

MATERIALE PLASTICO

Plastic material

PP



POLIPROPILENE

Polypropylene



BIANCO RAL 9016
White



AZZURRO NCS S2060-B
Azure

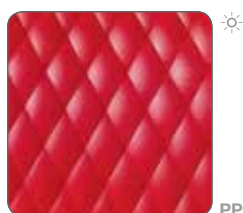

ROSSO RAL 3000
Red



ANTRACITE RAL 7016
Anthracite

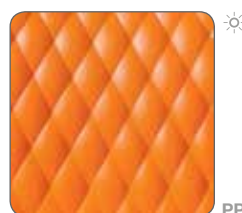

ARANCIO RAL 2003
Orange

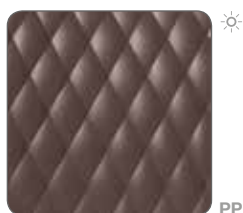

MOKA NCS S7005-Y50R
Mocha



NERO RAL 9005
Black

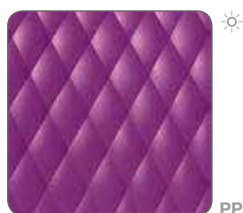

VIOLA RAL 4008
Violet



VERDE BOSS PANTONE 380 C
Boss Green



TORTORA NCS S4005-Y50R
Turtle-Dove

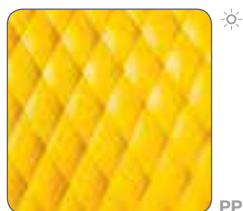

GIALLO RAL 1004
Yellow

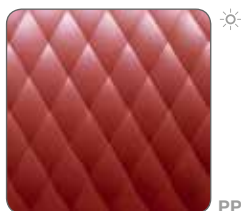

MARSALA PANTONE 18-1438
Marsala

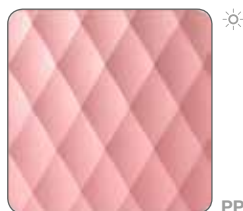

**ROSE QUARTZ*
PANTONE 13-1520**



**SERENITY*
PANTONE 15-3919**



**COLORE IGNIFUGO
BIANCO RAL 9016**
White, fire-resistant color

*FINO AD ESAURIMENTO SCORTE / While stocks last.

Finiture Sedute / Seating Finishes

TESSUTI Fabrics

ALTRI COLORI SU RICHIESTA
Other colors on request

A

NAPPA

91% PVC 9% PES

01 - BIANCO
White



2138 - AVORIO
Ivory



1354 - TESTA DI MORO
Dark Brown



781 - ROSSO
Red



991 - NERO
Black



B

FLIRT

100% PES

MARTINDALE 30.000

303 - ROSSO
Red



307 - MATTONE
Brick Red



401 - CORDA
Rope Beige

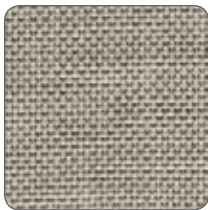

402 - MARRONE CHIARO
Light Brown



600 - GRIGIO BEIGE
Beige Grey



B

A511

90% PVC - 10% PES/CO

MARTINDALE 51.200

01 - BIANCO
White



04 - PANNA
Cream

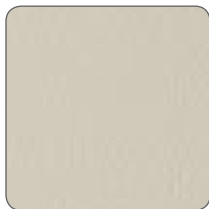

22 - ROSSO
Red



15 - VERDE OLIVA
Olive green



25 - PORPORA
Purple

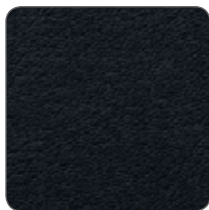

33 - TESTA DI MORO
Dark brown

38 - NERO
Black

Finiture Sedute / Seating Finishes

B

POLARIS PRO 

9,05% PA - 90,50% PVC

MARTINDALE 100.000

3142 - ARDESIA
Slate grey

3251 - PANNA
Cream

4740 - GIALLO SOLE
Sun yellow

4717 - TORTORA
Turtle Dove

3664 - NOCCIOLA
Hazelnut

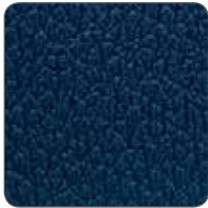

B

INCA 

88% PVC - 8% PL - 4%CO

MARTINDALE 50.000

01 - BIANCO
White

703 - TURCHESE
Turquoise

21 - VIOLETTO
Light Violet

603 - TORTORA
Black

17 - ROSSO
Red



25 - VERDE
Green

15 - MATTONE
Brick Red

11 - MARRONE
Brown

42 - NERO
Black

E

NORD WOOL 

70% WO - 25%PA - 5% AF

MARTINDALE 100.000

001 - VIOLETTO
Light Violet

701 - BLU SCURO
Dark Blue

403 - MARRONE SCURO
Dark Brown

802 - VERDE
Green

600 - GRIGIO
Grey



Finiture Sedute / Seating Finishes



LAMA 
65% WO-15%WP-20% PA

MARTINDALE 100.000

1 - BEIGE
Beige



5 - NERO
Black



6 - MARRONE
Brown



805 - VERDE
Green



806 - BLU CIELO
Sky blue



809 - MATTONE
Brick Red



SOLE CS 
100% TREVIRA CS

MARTINDALE 80.000

400 - GRIGIO
Grey



401 - CORDA
Rope Beige

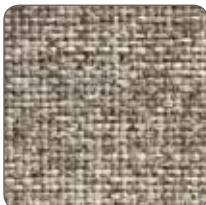

410 - VERDE
Green

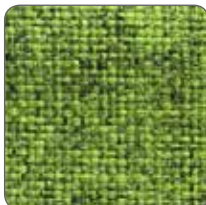

422 - BLU
Blue



433 - BORDEAUX
Bordeaux



Finiture Sedute / Seating Finishes

G **PAROTEGA NF** ✕
83% PVC - 17% CO

MARTINDALE 75.000

1652 - BIANCO
White



1656 - CIOCCOLATA
Chocolate



1658 - FANGO
Mud



1659 - NERO
Black



1665 - BORDEAUX
Bordeaux



1704 - MARRONE OLIVA
Olive brown



1661 - TORTORA
Turtle Dove

I **PURE WOOL** ✕
100% WO

MARTINDALE 65.000

101 - GRIGIO
Grey



404 - NOCCIOLA
Hazelnut



304 - BORDEAUX
Bordeaux



510 - VERDE
Green



702 - AZZURRO
Azure



METALMOBIL NON POTRÀ ESSERE CONSIDERATA RESPONSABILE DI EVENTUALI DANNI A TESSUTI DEI PROPRI PRODOTTI, CAUSATI DA CONTATTO O SFREGAMENTO CON MATERIALI CHE NE ALTERINO LE CARATTERISTICHE ESTETICHE. LA COLORAZIONE DI TESSUTI PUÒ LEGGERMENTE VARIARE DA UNA PARTITA ALL'ALTRA.

Metalmobil cannot be held responsible for any damage to fabrics used in the manufacture of its products caused by contact or rubbing with materials that alter its aesthetic characteristics. The colour of the fabrics may differ slightly from one lot to another.

Finiture Telai / Frames finishes

ACCIAIO

Steel

AC

ACCIAIO
Steel



VR BIANCO RAL 9016
VR White



VR BIANCO MARÉ RAL 9010 VR White Maré

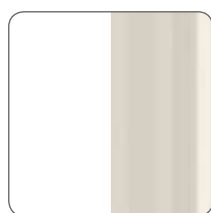

VR AVORIO RAL 9001
VR Ivory



VR TORTORA PANTONE 402C
VR Turtle Dove



VR GRIGIO ALU RAL 9006
VR Aluminium grey



VR GRIGIO RAL 7042
VR Grey



VR PELTRO
VR Pewter



VR ANTRACITE RAL 7016
VR Anthracite



VR NERO RAL 9005
VR Black

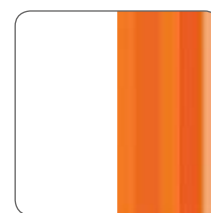

VR ARANCIO RAL 2003
VR Orange



VR ROSSO RAL 3000
VR Red



VR ROSSO MARÉ RAL 3003
VR Red Maré

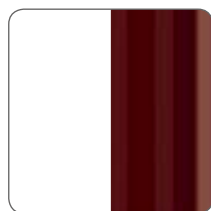

VR MARRONE RAL 8017
VR Brown

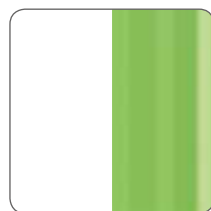

VR VERDE PANTONE 367 C
VR Green



VR VERDE INGLESE RAL 6005
VR English Green



CR CROMATO
CR Chrome



CR S CROMATO SATINATO*
CR S Satin chrome*

*DISPONIBILE SOLO PER / Only for:
Uni art. 550, 551, 552, 552G-378, 553, 558-5P, 558-5R, 565
Uni M art. 550M, 551M, 552M, 552MG, 553M, 558M-5P, 558M-5R, 565M-378

Finiture Telai / Frames finishes

LEGNO Wood

LE

LEGNO
Wood

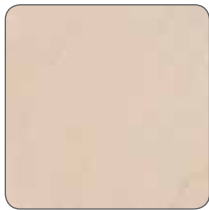

LE

FAGGIO TINTO ACERO
Maple stained beech wood



LE

FAGGIO NATURALE
Natural beech wood



LE

FAGGIO TINTO NOCE
Walnut stained beech wood



LE

FAGGIO TINTO NOCE CHIARO
Light walnut stained beech



LE

FAGGIO TINTO WENGÉ
Wengé stained beech wood



LE

FAGGIO TINTO NERO
Black stained beech wood

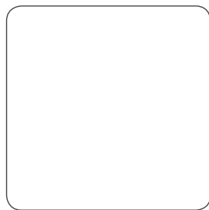

LE

FAGGIO TINTO CAMPIONE
Stained according to sample